

Simulink[®]

Simulation and Model-Based Design

- Modeling
- Simulation
- Implementation

How to Contact The MathWorks:



www.mathworks.com Web
comp.soft-sys.matlab Newsgroup



support@mathworks.com Technical support
suggest@mathworks.com Product enhancement suggestions
bugs@mathworks.com Bug reports
doc@mathworks.com Documentation error reports
service@mathworks.com Order status, license renewals, passcodes
info@mathworks.com Sales, pricing, and general information



508-647-7000 Phone



508-647-7001 Fax



The MathWorks, Inc. Mail
3 Apple Hill Drive
Natick, MA 01760-2098

For contact information about worldwide offices, see the MathWorks Web site.

Using Simulink

© COPYRIGHT 1990 - 2004 by The MathWorks, Inc.

The software described in this document is furnished under a license agreement. The software may be used or copied only under the terms of the license agreement. No part of this manual may be photocopied or reproduced in any form without prior written consent from The MathWorks, Inc.

FEDERAL ACQUISITION: This provision applies to all acquisitions of the Program and Documentation by, for, or through the federal government of the United States. By accepting delivery of the Program or Documentation, the government hereby agrees that this software or documentation qualifies as commercial computer software or commercial computer software documentation as such terms are used or defined in FAR 12.212, DFARS Part 227.72, and DFARS 252.227-7014. Accordingly, the terms and conditions of this Agreement and only those rights specified in this Agreement, shall pertain to and govern the use, modification, reproduction, release, performance, display, and disclosure of the Program and Documentation by the federal government (or other entity acquiring for or through the federal government) and shall supersede any conflicting contractual terms or conditions. If this License fails to meet the government's needs or is inconsistent in any respect with federal procurement law, the government agrees to return the Program and Documentation, unused, to The MathWorks, Inc.

MATLAB, Simulink, Stateflow, Handle Graphics, and Real-Time Workshop are registered trademarks, and TargetBox is a trademark of The MathWorks, Inc.

Other product or brand names are trademarks or registered trademarks of their respective holders.

Printing History:	November 1990	First printing	New for Simulink 1
	December 1996	Second printing	Revised for Simulink 2
	January 1999	Third printing	Revised for Simulink 3 (Release 11)
	November 2000	Fourth printing	Revised for Simulink 4 (Release 12)
	July 2002	Fifth printing	Revised for Simulink 5 (Release 13)
	April 2003	Online only	Revised for Simulink 5.1 (Release 13SP1)
	April 2004	Online only	Revised for Simulink 5.1.1 (Release 13SP1+)
	June 2004	Sixth printing	Revised for Simulink 6.0 (Release 14)

Getting Started

1

What Is Simulink?	1-2
Tool for Interactive Simulation	1-2
Tool for Model-Based Design	1-2
Related Products	1-3
Running a Demo Model	1-4
Description of the Demo	1-5
Some Things to Try	1-6
What This Demo Illustrates	1-7
Other Useful Demos	1-7
Building a Model	1-9
Setting Simulink Preferences	1-18
Miscellaneous Preferences	1-19
Font Preferences	1-20
Simulation Preferences	1-21

How Simulink Works

2

Introduction	2-2
Modeling Dynamic Systems	2-3
Block Diagram Semantics	2-3
Creating Models	2-4
Time	2-4
States	2-4
Block Parameters	2-7
Tunable Parameters	2-8
Block Sample Times	2-8

Custom Blocks	2-9
Systems and Subsystems	2-9
Signals	2-10
Block Methods	2-11
Model Methods	2-12
Simulating Dynamic Systems	2-13
Model Compilation	2-13
Link Phase	2-15
Simulation Loop Phase	2-15
Solvers	2-17
Zero-Crossing Detection	2-19
Algebraic Loops	2-24
Modeling and Simulating Discrete Systems	2-31
Specifying Sample Time	2-31
Purely Discrete Systems	2-35
Multirate Systems	2-35
Determining Step Size for Discrete Systems	2-36
Sample Time Propagation	2-37
Mixed Continuous and Discrete Systems	2-40

Simulink Basics

3

Starting Simulink	3-2
Opening Models	3-4
Avoiding Initial Model Open Delay	3-4
Entering Simulink Commands	3-5
Using the Simulink Menu Bar to Enter Commands	3-5
Using Context-Sensitive Menus to Enter Commands	3-5
Using the Simulink Toolbar to Enter Commands	3-5
Using the MATLAB Window to Enter Commands	3-6
Undoing a Command	3-6

Simulink Windows	3-7
Status Bar	3-7
Zooming Block Diagrams	3-7
Panning Block Diagrams	3-8
Saving a Model	3-9
Saving a Model in Earlier Formats	3-9
Printing a Block Diagram	3-12
Print Dialog Box	3-12
Print Command	3-13
Specifying Paper Size and Orientation	3-14
Positioning and Sizing a Diagram	3-15
Generating a Model Report	3-16
Model Report Options	3-17
Summary of Mouse and Keyboard Actions	3-19
Manipulating Blocks	3-19
Manipulating Lines	3-20
Manipulating Signal Labels	3-20
Manipulating Annotations	3-21
Ending a Simulink Session	3-22

Creating a Model

4

Creating a New Model	4-2
Selecting Objects	4-3
Selecting One Object	4-3
Selecting More Than One Object	4-3
Specifying Block Diagram Colors	4-5
Choosing a Custom Color	4-5
Defining a Custom Color	4-6

Specifying Colors Programmatically	4-6
Displaying Sample Time Colors	4-7
Connecting Blocks	4-9
Automatically Connecting Blocks	4-9
Manually Connecting Blocks	4-11
Disconnecting Blocks	4-15
Annotating Diagrams	4-16
Using TeX Formatting Commands in Annotations	4-17
Creating Annotations Programmatically	4-18
Creating Subsystems	4-20
Creating a Subsystem by Adding the Subsystem Block	4-20
Creating a Subsystem by Grouping Existing Blocks	4-21
Model Navigation Commands	4-23
Window Reuse	4-23
Labeling Subsystem Ports	4-24
Controlling Access to Subsystems	4-24
Creating Conditionally Executed Subsystems	4-26
Enabled Subsystems	4-26
Triggered Subsystems	4-31
Triggered and Enabled Subsystems	4-35
Conditional Execution Behavior	4-38
Modeling with Control Flow Blocks	4-42
Creating Conditional Control Flow Statements	4-42
Comparing Stateflow and Control Flow Statements	4-49
Referencing Models	4-53
Model Referencing Versus Subsystems	4-54
Creating a Model Reference	4-54
Opening a Referenced Model	4-56
Parameterizing Model References	4-56
Using Model Arguments	4-57
Model Block Sample Times	4-61
Referenced Model I/O	4-63
Model Interfaces	4-64

Building Simulation Targets	4-66
Converting Subsystems to Model References	4-67
Model Discretizer	4-68
Requirements	4-68
Discretizing a Model from the Model Discretizer GUI	4-69
Viewing the Discretized Model	4-78
Discretizing Blocks from the Simulink Model	4-81
Discretizing a Model from the MATLAB Command Window .	4-89
Using Callback Routines	4-90
Tracing Callbacks	4-90
Creating Model Callback Functions	4-90
Creating Block Callback Functions	4-92
Port Callback Parameters	4-95
Working with Model Workspaces	4-96
Changing a Model Workspace	4-97
Model Workspace Dialog Box	4-99
Managing Model Versions	4-103
Specifying the Current User	4-103
Model Properties Dialog Box	4-105
Creating a Model Change History	4-110
Version Control Properties	4-111

Working with Blocks

5

About Blocks	5-2
Block Data Tips	5-2
Virtual Blocks	5-2
Editing Blocks	5-4
Copying and Moving Blocks from One Window to Another ...	5-4
Moving Blocks in a Model	5-5
Copying Blocks in a Model	5-6

Deleting Blocks	5-6
Setting Block Parameters	5-7
Setting Block-Specific Parameters	5-7
Tuning Parameters	5-8
Block Properties Dialog Box	5-9
State Properties Dialog Box	5-12
Changing a Block's Appearance	5-14
Changing the Orientation of a Block	5-14
Resizing a Block	5-14
Displaying Parameters Beneath a Block	5-15
Using Drop Shadows	5-15
Manipulating Block Names	5-15
Specifying a Block's Color	5-17
Displaying Block Outputs	5-18
Enabling Port Values Display	5-18
Port Values Display Options	5-19
Controlling and Displaying the Sorted Order	5-20
Displaying the Sorted Order	5-20
Assigning Block Priorities	5-20
Lookup Table Editor	5-22
Browsing LUT Blocks	5-23
Editing Table Values	5-24
Displaying N-D Tables	5-25
Plotting LUT Tables	5-26
Editing Custom LUT Blocks	5-27
Working with Block Libraries	5-29
Terminology	5-29
Simulink Block Library	5-29
Creating a Library	5-30
Modifying a Library	5-30
Creating a Library Link	5-30
Disabling Library Links	5-31
Modifying a Linked Subsystem	5-31

Propagating Link Modifications	5-32
Updating a Linked Block	5-32
Updating Links to Reflect Block Path Changes	5-32
Breaking a Link to a Library Block	5-33
Finding the Library Block for a Reference Block	5-34
Library Link Status	5-34
Displaying Library Links	5-35
Getting Information About Library Blocks	5-36
Browsing Block Libraries	5-36
Accessing Block Data During Simulation	5-40

Working with Signals

6

Signal Basics	6-2
About Signals	6-2
Creating Signals	6-2
Signal Labels	6-2
Displaying Signal Values	6-3
Signal Data Types	6-3
Signal Dimensions	6-3
Complex Signals	6-4
Virtual Signals	6-4
Control Signals	6-6
Signal Buses	6-6
Checking Signal Connections	6-9
Signal Glossary	6-10
Determining Output Signal Dimensions	6-12
Signal and Parameter Dimension Rules	6-13
Scalar Expansion of Inputs and Parameters	6-14
The Signal & Scope Manager	6-16
Generator and Viewer Types	6-17
Generator and Viewer Objects	6-18
Signals connected to Generator/Viewer	6-21

The Signal Selector	6-23
Port/Axis Selector	6-23
Model Hierarchy	6-24
Inputs/Signals List	6-24
Logging Signals	6-27
Enabling Signal Logging	6-27
Specifying a Logging Name	6-27
Limiting the Data Logged for a Signal	6-28
Logging Referenced Model Signals	6-28
Accessing Logged Signal Data	6-29
Signal Properties Dialog Box	6-30
Logging and Accessibility Options	6-32
Real-Time Workshop Options	6-33
Documentation Options	6-34
Working with Test Points	6-35
Designating a Signal as a Test Point	6-35
Displaying Test Point Indicators	6-36
Displaying Signal Properties	6-37
Signal Names	6-38
Signal Labels	6-39
Displaying Signals Represented by Virtual Signals	6-40
Working with Signal Groups	6-41
Creating a Signal Group Set	6-41
The Signal Builder Dialog Box	6-42
Editing Signal Groups	6-44
Editing Signals	6-44
Editing Waveforms	6-46
Signal Builder Time Range	6-50
Exporting Signal Group Data	6-51
Simulating with Signal Groups	6-51
Simulation Options Dialog Box	6-52
Bus Editor	6-55
Bus types in base workspace	6-56

Bus elements	6-57
Bus name	6-57
Header file	6-58
Bus description	6-58

Working with Data

7

Working with Data Types	7-2
Data Types Supported by Simulink	7-2
Fixed-Point Data	7-3
Fixed-Point Settings Interface	7-4
Block Support for Data and Numeric Signal Types	7-4
Specifying Block Parameter Data Types	7-5
Creating Signals of a Specific Data Type	7-5
Displaying Port Data Types	7-5
Data Type Propagation	7-6
Data Typing Rules	7-6
Enabling Strict Boolean Type Checking	7-7
Typecasting Signals	7-7
Typecasting Parameters	7-7
 Working with Data Objects	 7-10
About Data Object Classes	7-10
About Data Object Methods	7-11
Constructors	7-12
Creating Data Objects	7-12
About Object Properties	7-14
Changing Object Properties	7-15
Saving and Loading Data Objects	7-16
Using Data Objects in Simulink Models	7-16
Creating Persistent Data Objects	7-17
 Subclassing Simulink Data Classes	 7-18
 Associating User Data with Blocks	 7-30

Modeling with Simulink

8

Modeling Equations	8-2
Converting Celsius to Fahrenheit	8-2
Modeling a Continuous System	8-3
Avoiding Invalid Loops	8-6
Tips for Building Models	8-8

Exploring, Searching, and Browsing Models

9

The Model Explorer	9-2
Model Hierarchy Pane	9-3
Contents Pane	9-4
Dialog Pane	9-9
Main Toolbar	9-9
Search Bar	9-11
The Finder	9-16
Filter Options	9-18
Search Criteria	9-18
The Model Browser	9-22
Using the Model Browser on Windows	9-22
Using the Model Browser on UNIX	9-24

Running Simulations

10

Simulation Basics	10-2
Controlling Execution of a Simulation	10-3
Interacting with a Running Simulation	10-5

Specifying a Simulation Start and Stop Time	10-6
Choosing a Solver	10-7
Choosing a Solver Type	10-7
Choosing a Fixed-Step Solver	10-8
Choosing a Variable-Step Solver	10-12
Importing and Exporting Simulation Data	10-16
Importing Input Data from the MATLAB Workspace	10-16
Exporting Output Data to the MATLAB Workspace	10-20
Importing and Exporting States	10-22
Limiting Output	10-23
Specifying Output Options	10-23
Configuration Sets	10-26
The Active Set	10-26
Activating a Configuration Set	10-26
Copying and Moving Configuration Sets	10-26
Creating Configuration Sets	10-27
Setting Values in Configuration Sets	10-27
Configuration Set API	10-27
The Model Configuration Dialog Box	10-28
The Configuration Parameters Dialog Box	10-30
The Solver Pane	10-31
Data Import/Export Pane	10-39
The Optimization Pane	10-43
The Diagnostics Pane	10-48
Hardware Implementation Pane	10-63
Model Referencing Pane	10-67
Diagnosing Simulation Errors	10-72
Simulation Diagnostics Viewer	10-72
Creating Custom Simulation Error Messages	10-73
Improving Simulation Performance and Accuracy	10-76
Speeding Up the Simulation	10-76
Improving Simulation Accuracy	10-77

Running a Simulation Programmatically	10-78
Using the sim Command	10-78
Using the set_param Command	10-78

Analyzing Simulation Results

11

Viewing Output Trajectories	11-2
Using the Scope Block	11-2
Using Return Variables	11-2
Using the To Workspace Block	11-3
 Linearizing Models	 11-4
 Finding Steady-State Points	 11-7

Creating Masked Subsystems

12

About Masks	12-2
Mask Features	12-2
Creating Masks	12-4
 Masked Subsystem Example	 12-5
Creating Mask Dialog Box Prompts	12-6
Creating the Block Description and Help Text	12-8
Creating the Block Icon	12-8
 Masking a Subsystem	 12-10
 The Mask Editor	 12-12
The Icon Pane	12-14
The Parameters Pane	12-17
Control Types	12-20

The Initialization Pane	12-23
The Documentation Pane	12-25
Linking Mask Parameters to Block Parameters	12-27
Creating Dynamic Dialogs for Masked Blocks	12-28
Setting Masked Block Dialog Parameters	12-28
Predefined Masked Dialog Parameters	12-29

Simulink Debugger

13

Introduction	13-2
Using the Debugger's Graphical User Interface	13-3
Toolbar	13-4
Breakpoints Pane	13-6
Simulation Loop Pane	13-7
Outputs Pane	13-8
Sorted List Pane	13-9
Status Pane	13-10
Using the Debugger's Command-Line Interface	13-11
Method ID	13-11
Block ID	13-11
Accessing the MATLAB Workspace	13-11
Getting Online Help	13-12
Starting the Debugger	13-13
Starting a Simulation	13-14
Running a Simulation Step by Step	13-15
Stepping Commands	13-17
Continuing a Simulation	13-18
Running a Simulation Nonstop	13-19

Debug Pointer	13-20
Setting Breakpoints	13-22
Setting Unconditional Breakpoints	13-22
Setting Conditional Breakpoints	13-24
Displaying Information About the Simulation	13-28
Displaying Block I/O	13-28
Displaying Algebraic Loop Information	13-30
Displaying System States	13-31
Displaying Integration Information	13-31
Displaying Information About the Model	13-32
Displaying a Model's Sorted Lists	13-32
Displaying a Block	13-33

Simulink Accelerator

14

The Simulink Accelerator	14-2
Accelerator Limitations	14-2
How the Accelerator Works	14-2
Running the Simulink Accelerator	14-3
Handling Changes in Model Structure	14-4
Increasing Performance of Accelerator Mode	14-5
Blocks That Do Not Show Speed Improvements	14-6
Using the Simulink Accelerator with the Simulink Debugger	14-7
Interacting with the Simulink Accelerator Programmatically	14-8
Comparing Performance	14-9
Customizing the Simulink Accelerator Build Process	14-10
Controlling S-Function Execution	14-11
Profiler	14-12
How the Profiler Works	14-12
Enabling the Profiler	14-14
The Simulation Profile	14-15

Introduction to Embedded MATLAB Function Blocks . . .	15-2
What Is an Embedded MATLAB Function Block?	15-2
Why Use Embedded MATLAB Function Blocks?	15-4
Creating an Example Embedded MATLAB Function	15-7
Adding an Embedded MATLAB Function Block to a Model . .	15-8
Programming the Embedded MATLAB Function	15-9
Checking the Function for Errors	15-15
Defining Inputs and Outputs	15-17
Debugging an Embedded MATLAB Function	15-20
Debugging the Function in Simulation	15-20
Watching Function Variables During Simulation	15-27
The Embedded MATLAB Function Editor	15-30
Changing the Embedded MATLAB Editor	15-31
Editing the Embedded MATLAB Function	15-34
Defining Embedded MATLAB Function Arguments	15-36
Debugging Embedded MATLAB Functions	15-37
Typing Function Arguments	15-39
Inheriting Argument Data Types	15-41
Selecting Types for Arguments	15-42
Specifying Argument Types with Expressions	15-43
Sizing Function Arguments	15-45
Inheriting Argument Sizes from Simulink	15-47
Specifying Argument Sizes with Expressions	15-48
Parameter Arguments in Embedded MATLAB Functions	15-50
Local Variables in Embedded MATLAB Functions	15-52
Declaring Local Variables Implicitly	15-52
Declaring Local Complex Variables Implicitly	15-53
Functions in Embedded MATLAB Functions	15-56
Calling Subfunctions in Embedded MATLAB Functions . . .	15-56

Calling Embedded MATLAB Run-Time Library Functions .	15-57
Calling MATLAB Functions	15-57

Index

Getting Started

The following sections use examples to give you a quick introduction to using Simulink[®] to model and simulate dynamic systems.

What Is Simulink? (p. 1-2)	Introduces Simulink.
Running a Demo Model (p. 1-4)	Example of how to run a Simulink model.
Building a Model (p. 1-9)	Example of how to build a Simulink model.
Setting Simulink Preferences (p. 1-18)	How to set Simulink preferences.

What Is Simulink?

Simulink[®] is a software package for modeling, simulating, and analyzing dynamic systems. It supports linear and nonlinear systems, modeled in continuous time, sampled time, or a hybrid of the two. Systems can also be multirate, i.e., have different parts that are sampled or updated at different rates.

Tool for Interactive Simulation

Simulink encourages you to try things out. You can easily build models from scratch, or take an existing model and add to it. Simulations are interactive, so you can change parameters on the fly and immediately see what happens. You have instant access to all the analysis tools in MATLAB[®], so you can take the results and analyze and visualize them. A goal of Simulink is to give you a sense of the *fun* of modeling and simulation, through an environment that encourages you to pose a question, model it, and see what happens.

Simulink is also practical. With thousands of engineers around the world using it to model and solve real problems, knowledge of this tool will serve you well throughout your professional career.

Tool for Model-Based Design

With Simulink, you can move beyond idealized linear models to explore more realistic nonlinear models, factoring in friction, air resistance, gear slippage, hard stops, and the other things that describe real-world phenomena. Simulink turns your computer into a lab for modeling and analyzing systems that simply wouldn't be possible or practical otherwise, whether the behavior of an automotive clutch system, the flutter of an airplane wing, the dynamics of a predator-prey model, or the effect of the monetary supply on the economy.

For modeling, Simulink provides a graphical user interface (GUI) for building models as block diagrams, using click-and-drag mouse operations. With this interface, you can draw the models just as you would with pencil and paper (or as most textbooks depict them). This is a far cry from previous simulation packages that require you to formulate differential equations and difference equations in a language or program. Simulink includes a comprehensive block library of sinks, sources, linear and nonlinear components, and connectors. You can also customize and create your own blocks. For information on creating your own blocks, see the separate *Writing S-Functions* guide.

Models are hierarchical, so you can build models using both top-down and bottom-up approaches. You can view the system at a high level, then double-click blocks to go down through the levels to see increasing levels of model detail. This approach provides insight into how a model is organized and how its parts interact.

After you define a model, you can simulate it, using a choice of integration methods, either from the Simulink menus or by entering commands in the MATLAB Command Window. The menus are particularly convenient for interactive work, while the command-line approach is very useful for running a batch of simulations (for example, if you are doing Monte Carlo simulations or want to sweep a parameter across a range of values). Using scopes and other display blocks, you can see the simulation results while the simulation is running. In addition, you can change parameters and immediately see what happens, for “what if” exploration. The simulation results can be put in the MATLAB workspace for postprocessing and visualization.

Model analysis tools include linearization and trimming tools, which can be accessed from the MATLAB command line, plus the many tools in MATLAB and its application toolboxes. And because MATLAB and Simulink are integrated, you can simulate, analyze, and revise your models in either environment at any point.

Related Products

The MathWorks provides several products that are especially relevant to the kinds of tasks you can perform with Simulink and that extend the capabilities of Simulink. For information about these related products, see <http://www.mathworks.com/products/simulink/related.html>.

Running a Demo Model

An interesting demo program provided with Simulink models the thermodynamics of a house. To run this demo, follow these steps:

- 1 Start MATLAB. See your MATLAB documentation if you're not sure how to do this.
- 2 Run the demo model by typing thermo in the MATLAB Command Window. This command starts up Simulink and creates a model window that contains this model.

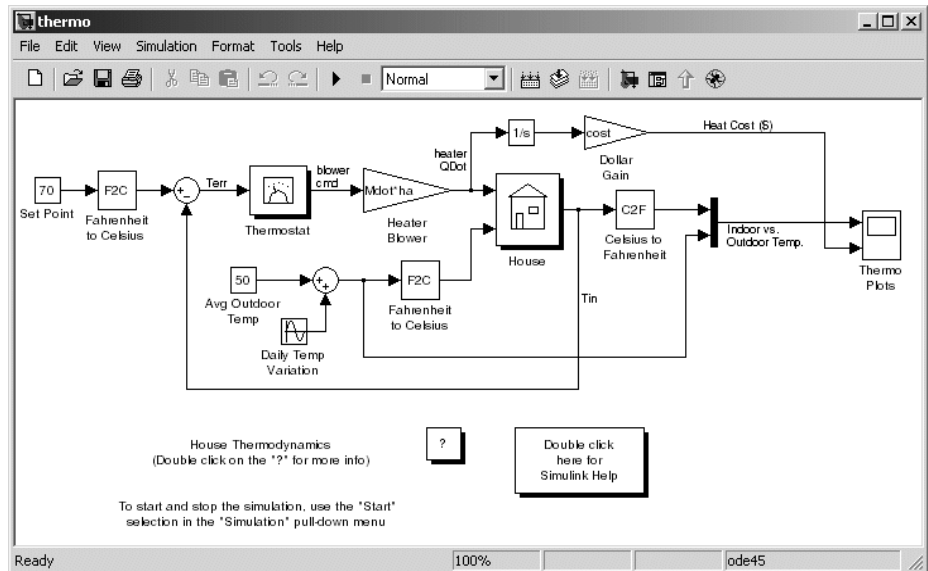

- 3 Double-click the Scope block labeled Thermo Plots.

The Scope block displays two plots labeled Indoor vs. Outdoor Temp and Heat Cost (\$), respectively.

- 4 To start the simulation, pull down the **Simulation** menu and choose the **Start** command (or, on Microsoft Windows, click the **Start** button on the Simulink toolbar). As the simulation runs, the indoor and outdoor temperatures appear in the Indoor vs. Outdoor Temp plot and the cumulative heating cost appears in the Heat Cost (\$) plot.
- 5 To stop the simulation, choose the **Stop** command from the **Simulation** menu (or click the **Pause** button on the toolbar). If you want to explore other parts of the model, look over the suggestions in “Some Things to Try” on page 1-6.
- 6 When you’re finished running the simulation, close the model by choosing **Close** from the **File** menu.

Description of the Demo

The demo models the thermodynamics of a house. The thermostat is set to 70 degrees Fahrenheit and is affected by the outside temperature, which varies by applying a sine wave with amplitude of 15 degrees to a base temperature of 50 degrees. This simulates daily temperature fluctuations.

The model uses subsystems to simplify the model diagram and create reusable systems. A subsystem is a group of blocks that is represented by a Subsystem block. This model contains five subsystems: one named Thermostat, one named House, and three Temp Convert subsystems (two convert Fahrenheit to Celsius, one converts Celsius to Fahrenheit).

The internal and external temperatures are fed into the House subsystem, which updates the internal temperature. Double-click the House block to see the underlying blocks in that subsystem.

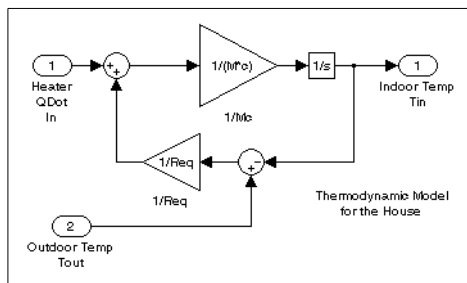

House subsystem

The Thermostat subsystem models the operation of a thermostat, determining when the heating system is turned on and off. Double-click the block to see the underlying blocks in that subsystem.

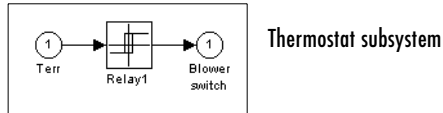

Both the outside and inside temperatures are converted from Fahrenheit to Celsius by identical subsystems.

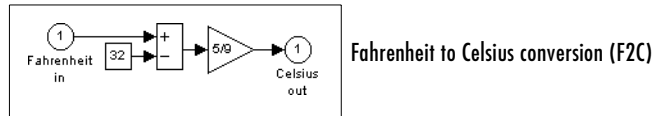

When the heat is on, the heating costs are computed and displayed on the Heat Cost (\$) plot on the Thermo Plots Scope. The internal temperature is displayed on the Indoor Temp Scope.

Some Things to Try

Here are several things to try to see how the model responds to different parameters:

- Each Scope block contains one or more signal display areas and controls that enable you to select the range of the signal displayed, zoom in on a portion of the signal, and perform other useful tasks. The horizontal axis represents time and the vertical axis represents the signal value.
- The Constant block labeled Set Point (at the top left of the model) sets the desired internal temperature. Open this block and reset the value to 80 degrees. See how the indoor temperature and heating costs change. Also, adjust the outside temperature (the Avg Outdoor Temp block) and see how it affects the simulation.
- Adjust the daily temperature variation by opening the Sine Wave block labeled Daily Temp Variation and changing the **Amplitude** parameter.

What This Demo Illustrates

This demo illustrates several tasks commonly used when you are building models:

- Running the simulation involves specifying parameters and starting the simulation with the **Start** command, described in “Diagnosing Simulation Errors” on page 10-72.
- You can encapsulate complex groups of related blocks in a single block, called a subsystem. See “Creating Subsystems” on page 4-20 for more information.
- You can customize the appearance of and design a dialog box for a block by using the masking feature, described in detail in Chapter 12, “Creating Masked Subsystems.” The thermo model uses the masking feature to customize the appearance of all the Subsystem blocks that it contains.
- Scope blocks display graphic output much as an actual oscilloscope does.

Other Useful Demos

Other demos illustrate useful modeling concepts. You can access these demos from the MATLAB Command Window:

- 1 Click the **Start** button on the bottom left corner of the MATLAB Command Window.

The **Start** menu appears.

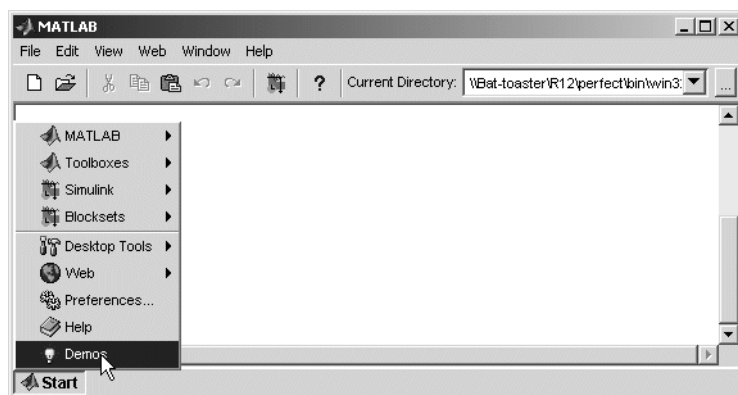

2 Select **Demos** from the menu.

The MATLAB Help browser appears with the **Demos** pane selected.

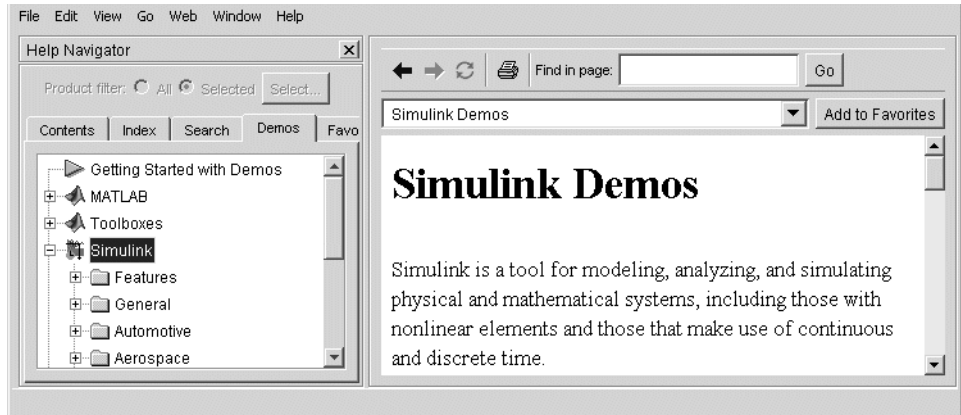

3 Click the **Simulink** entry in the **Demos** pane.

The entry expands to show groups of Simulink demos. Use the browser to navigate to demos of interest. The browser displays explanations of each demo and includes a link to the demo itself. Click on a demo link to start the demo.

Building a Model

This example shows you how to build a model using many of the model-building commands and actions you will use to build your own models. The instructions for building this model in this section are brief. All the tasks are described in more detail in the next chapter.

The model integrates a sine wave and displays the result along with the sine wave. The block diagram of the model looks like this.

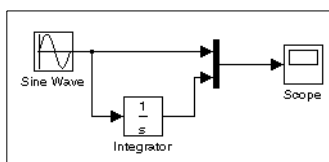

To create the model, first enter `simulink` in the MATLAB Command Window. On Microsoft Windows, the Simulink Library Browser appears.

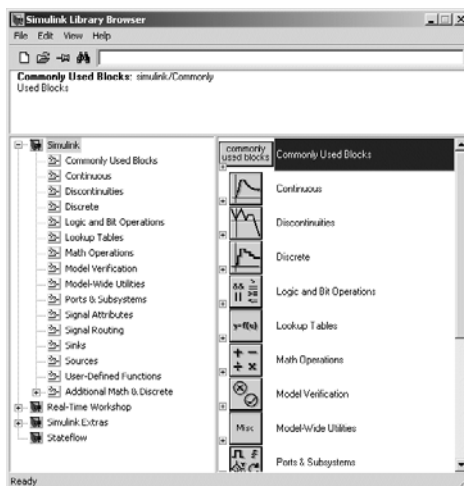

On UNIX, the Simulink library window appears.

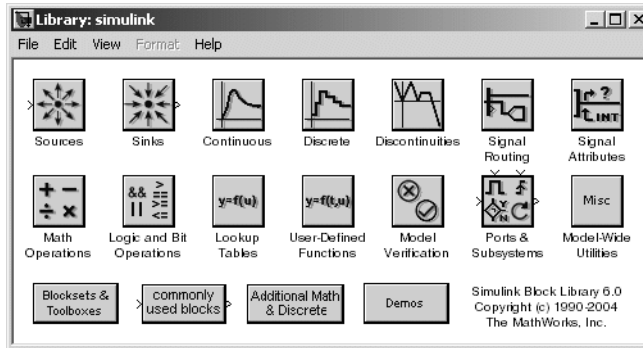

To create a new model on UNIX, select **Model** from the **New** submenu of the Simulink library window's **File** menu. To create a new model on Windows, click the New Model button on the Library Browser's toolbar.

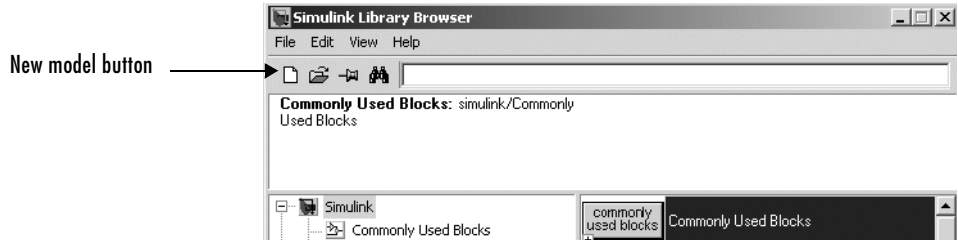

Simulink opens a new model window.

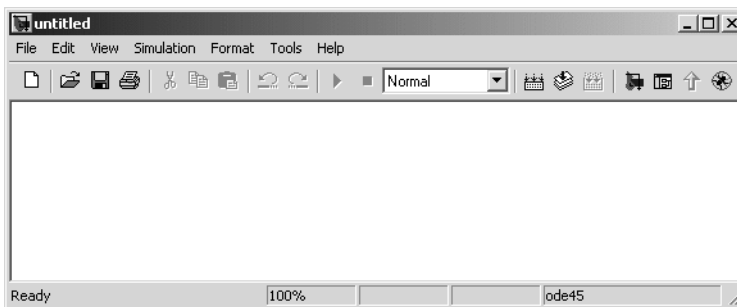

To create this model, you need to copy blocks into the model from the following Simulink block libraries:

- Sources library (the Sine Wave block)
- Sinks library (the Scope block)
- Continuous library (the Integrator block)
- Signal Routing library (the Mux block)

You can copy a Sine Wave block from the Sources library, using the Library Browser (Windows only) or the Sources library window (UNIX and Windows).

To copy the Sine Wave block from the Library Browser, first expand the Library Browser tree to display the blocks in the Sources library. Do this by clicking the Sources node to display the Sources library blocks. Finally, click the Sine Wave node to select the Sine Wave block.

Here is how the Library Browser should look after you have done this.

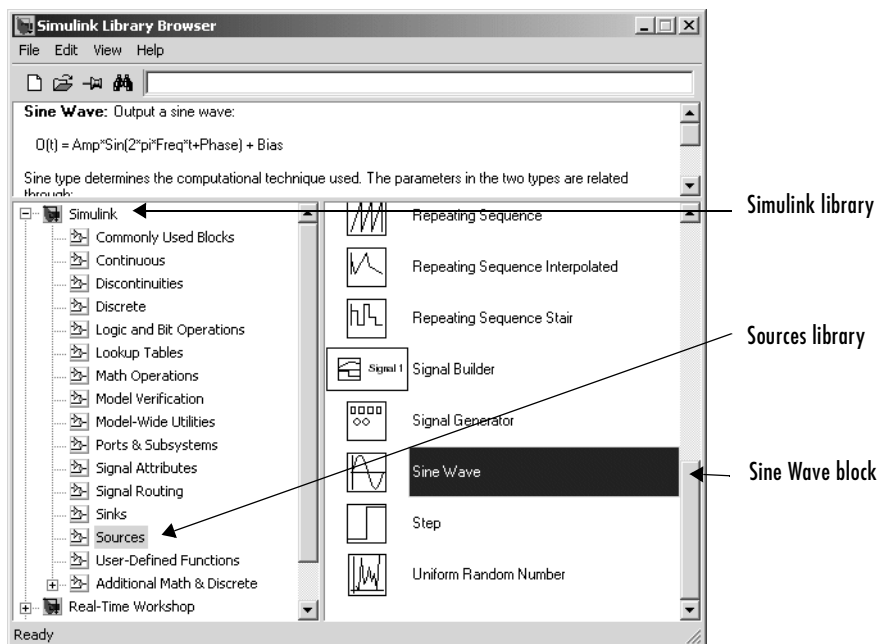

Now drag a copy of the Sine Wave block from the browser and drop it in the model window.

To copy the Sine Wave block from the Sources library window, open the Sources window by double-clicking the Sources icon in the Simulink library window. (On Windows, you can open the Simulink library window by right-clicking the Simulink node in the Library Browser and then clicking the resulting **Open Library** button.)

Simulink displays the Sources library window.

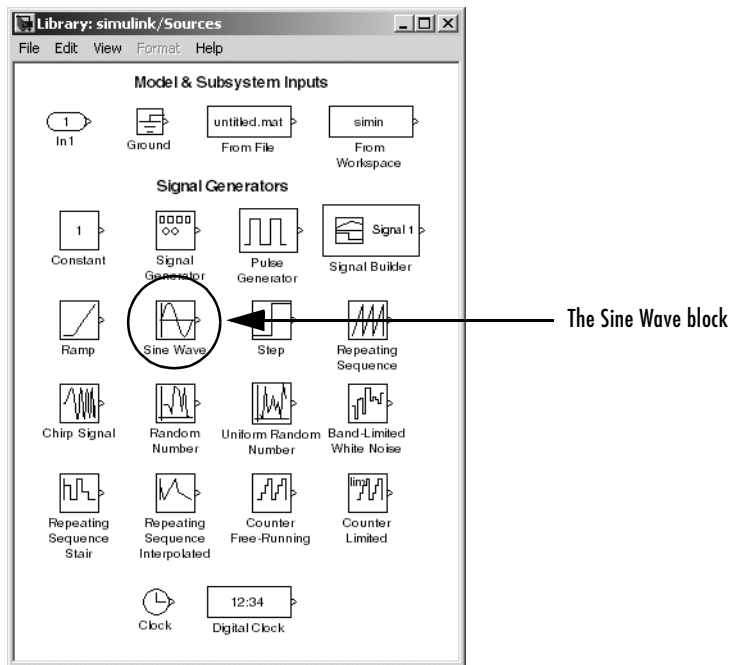

Now drag the Sine Wave block from the Sources window to your model window.

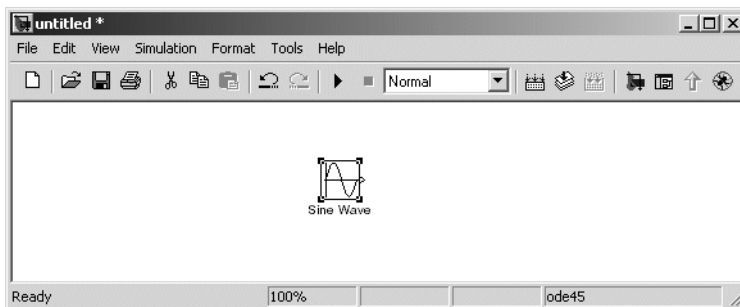

Copy the rest of the blocks in a similar manner from their respective libraries into the model window. You can move a block from one place in the model window to another by dragging the block. You can move a block a short distance by selecting the block, then pressing the arrow keys.

With all the blocks copied into the model window, the model should look something like this.

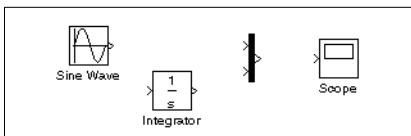

If you examine the blocks, you see an angle bracket on the right of the Sine Wave block and two on the left of the Mux block. The $>$ symbol pointing out of a block is an *output port*; if the symbol points to a block, it is an *input port*. A signal travels out of an output port and into an input port of another block through a connecting line. When the blocks are connected, the port symbols disappear.

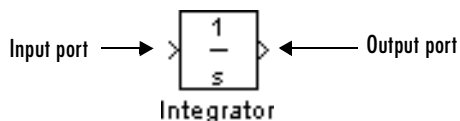

Now it's time to connect the blocks. Connect the Sine Wave block to the top input port of the Mux block. Position the pointer over the output port on the

right side of the Sine Wave block. Notice that the cursor shape changes to crosshairs.

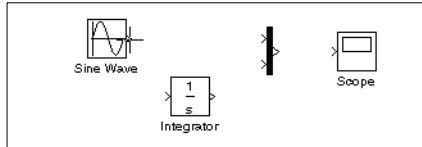

Hold down the mouse button and move the cursor to the top input port of the Mux block.

Notice that the line is dashed while the mouse button is down and that the cursor shape changes to double-lined crosshairs as it approaches the Mux block.

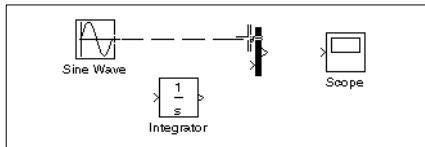

Now release the mouse button. The blocks are connected. You can also connect the line to the block by releasing the mouse button while the pointer is over the block. If you do, the line is connected to the input port closest to the cursor's position.

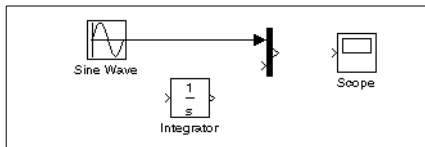

If you look again at the model at the beginning of this section (see “Building a Model” on page 1-9), you’ll notice that most of the lines connect output ports of blocks to input ports of other blocks. However, one line connects a *line* to the input port of another block. This line, called a *branch line*, connects the Sine Wave output to the Integrator block, and carries the same signal that passes from the Sine Wave block to the Mux block.

Drawing a branch line is slightly different from drawing the line you just drew. To weld a connection to an existing line, follow these steps:

- 1 First, position the pointer *on the line* between the Sine Wave and the Mux block.

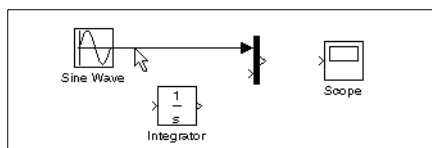

- 2 Press and hold down the **Ctrl** key (or click the right mouse button). Press the mouse button, then drag the pointer to the Integrator block's input port or over the Integrator block itself.

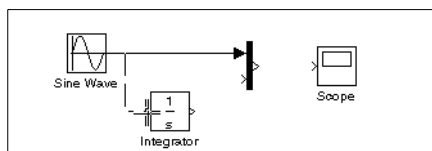

- 3 Release the mouse button. Simulink draws a line between the starting point and the Integrator block's input port.

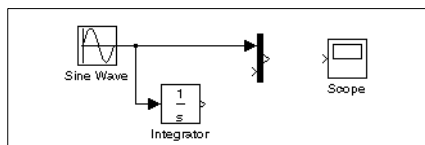

Finish making block connections. When you're done, your model should look something like this.

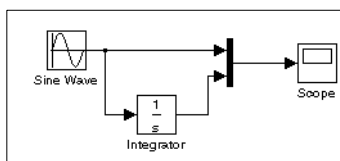

Now set up Simulink to run the simulation for 10 seconds. First, open the **Configuration Parameters** dialog box by choosing **Configuration Parameters** from the **Simulation** menu. On the dialog box that appears, notice that the **Stop time** is set to 10.0 (its default value).

Stop time parameter

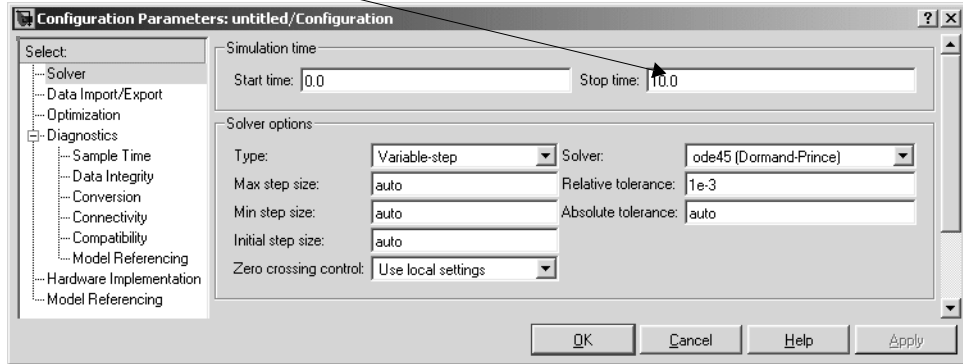

Close the **Configuration Parameters** dialog box by clicking the **OK** button. Simulink applies the parameters and closes the dialog box.

Now double-click the Scope block to open its display window. Finally, choose **Start** from the **Simulation** menu and watch the simulation output on the Scope.

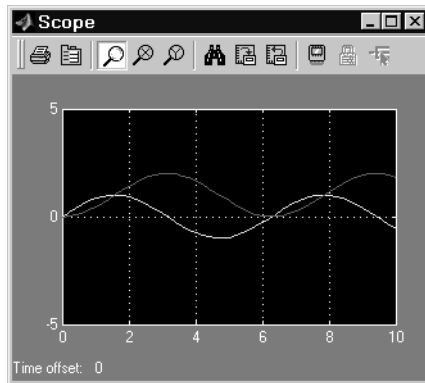

The simulation stops when it reaches the stop time specified in the **Configuration Parameters** dialog box or when you choose **Stop** from the **Simulation** menu or click the **Stop** button on the model window's toolbar (Windows only).

To save this model, choose **Save** from the **File** menu and enter a filename and location. That file contains the description of the model.

To terminate Simulink and MATLAB, choose **Exit MATLAB** (on a Microsoft Windows system) or **Quit MATLAB** (on a UNIX system). You can also enter `quit` in the MATLAB Command Window. If you want to leave Simulink but not terminate MATLAB, just close all Simulink windows.

This exercise shows you how to perform some commonly used model-building tasks. These and other tasks are described in more detail in Chapter 4, "Creating a Model."

Setting Simulink Preferences

The MATLAB **Preferences** dialog box allows you to specify default settings for some Simulink options. To display the **Preferences** dialog box, select **Preferences** from the Simulink **File** menu.

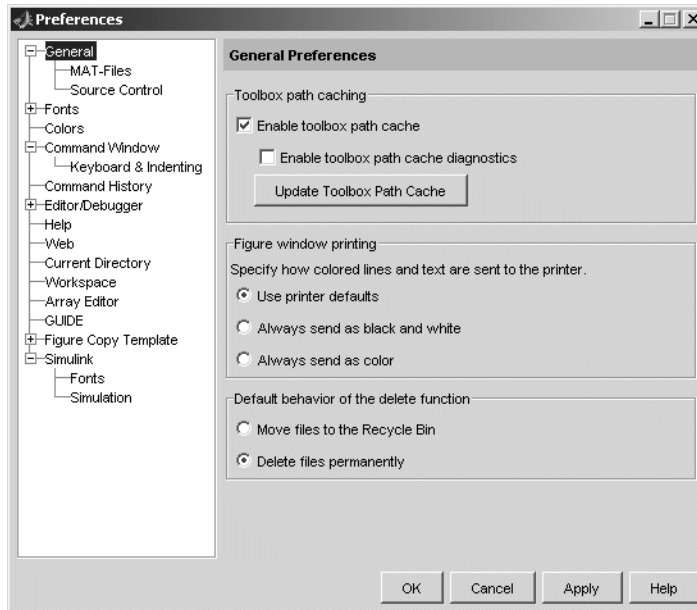

Miscellaneous Preferences

Selecting Simulink in the left hand pane of the preferences dialog box displays a **Simulink Preferences** pane on the right side of the dialog box.

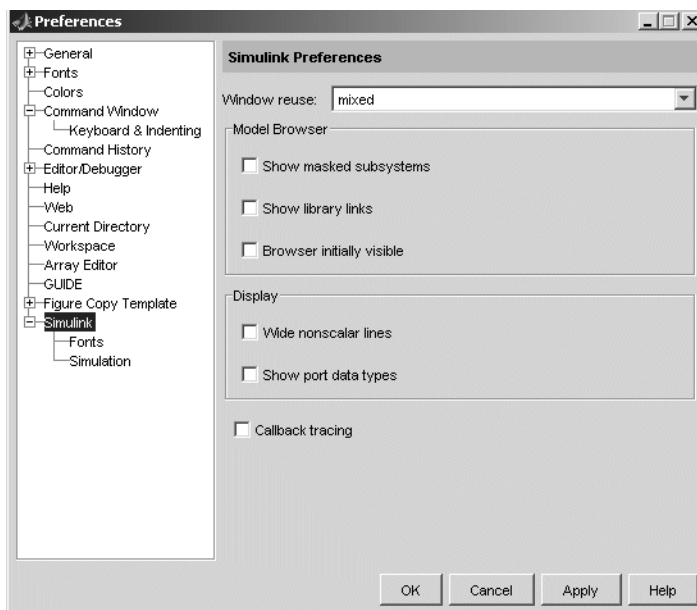

This pane allows you to specify the following Simulink preferences.

Window reuse

Specifies whether Simulink uses existing windows or opens new windows to display a model's subsystems (see "Window Reuse" on page 4-23).

Model Browser

Specifies whether Simulink displays the browser when you open a model and whether the browser shows blocks imported from subsystems and the contents of masked subsystems (see "The Model Browser" on page 9-22).

Display

Specifies whether to use thick lines to display nonscalar connections between blocks and whether to display port data types on the block diagram (see "Working with Signal Groups" on page 6-41).

Callback tracing

Specifies whether to display the model callbacks that Simulink invokes when simulating a model (see “Using Callback Routines” on page 4-90).

Font Preferences

Selecting the Fonts subnode of the Simulink node in the left side of the dialog box displays a stack of tabbed panes on the right side of the dialog box.

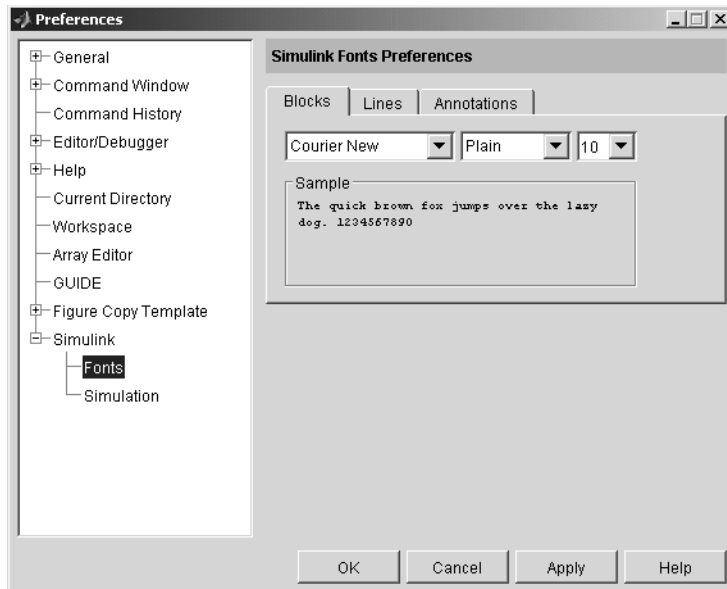

The panes allow you to specify your preferred fonts for block and line labels and model annotations, respectively.

Simulation Preferences

Selecting the Simulation node beneath the Simulink node in the left side of the dialog box displays a button to start the Model Explorer (see “The Model Explorer” on page 9-2).

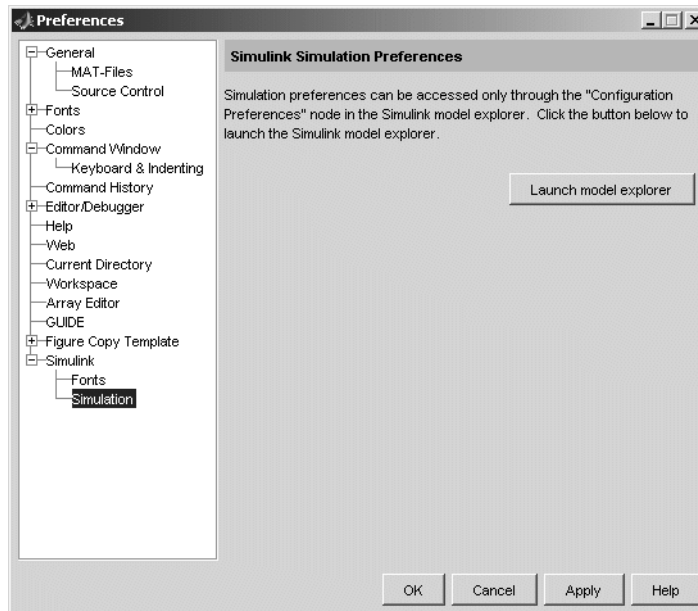

Use the Model Explorer to set your simulation preferences.

How Simulink Works

The following sections explain how Simulink models and simulates dynamic systems. This information can be helpful in creating models and interpreting simulation results.

Introduction (p. 2-2)	Brief overview of Simulink.
Modeling Dynamic Systems (p. 2-3)	How Simulink models a dynamic system.
Simulating Dynamic Systems (p. 2-13)	How Simulink simulates a dynamic system.
Modeling and Simulating Discrete Systems (p. 2-31)	How Simulink models and simulates discrete systems.

Introduction

Simulink is a software package that enables you to model, simulate, and analyze systems whose outputs change over time. Such systems are often referred to as dynamic systems. Simulink can be used to explore the behavior of a wide range of real-world dynamic systems, including electrical circuits, shock absorbers, braking systems, and many other electrical, mechanical, and thermodynamic systems. This section explains how Simulink works.

Simulating a dynamic system is a two-step process with Simulink. First, a user creates a block diagram, using the Simulink model editor, that graphically depicts time-dependent mathematical relationships among the system's inputs, states, and outputs. The user then commands Simulink to simulate the system represented by the model from a specified start time to a specified stop time.

Modeling Dynamic Systems

A Simulink block diagram model is a graphical representation of a mathematical model of a dynamic system. A mathematical model of a dynamic system is described by a set of equations. The mathematical equations described by a block diagram model are known as algebraic, differential, and/or difference equations.

Block Diagram Semantics

A classic block diagram model of a dynamic system graphically consists of blocks and lines (signals). The history of these block diagram model is derived from engineering areas such as Feedback Control Theory and Signal Processing. A block within a block diagram defines a dynamic system in itself. The relationships between each elementary dynamic system in a block diagram are illustrated by the use of signals connecting the blocks. Collectively the blocks and lines in a block diagram describe an overall dynamic system.

Simulink extends these classic block diagram models by introducing the notion of two classes of blocks, nonvirtual block and virtual blocks. Nonvirtual blocks represent elementary systems. A virtual block is provided for graphical organizational convenience and plays no role in the definition of the system of equations described by the block diagram model. Examples of virtual blocks are the Bus Creator and Bus Selector which are used to reduce block diagram clutter by managing groups of signals as a “bundle.” You can use virtual blocks to improve the readability of your models.

In general, block and lines can be used to describe many “models of computations.” One example would be a flow chart. A flow chart consists of blocks and lines, but one cannot describe general dynamic systems using flow chart semantics.

The term “time-based block diagram” is used to distinguish block diagrams that describe dynamic systems from that of other forms of block diagrams. In Simulink, we use the term block diagram (or model) to refer to a time-based block diagram unless the context requires explicit distinction.

To summarize the meaning of time-based block diagrams:

- Simulink block diagrams define time-based relationships between signals and state variables. The solution of a block diagram is obtained by evaluating these relationships over time, where time starts at a user

specified “start time” and ends at a user specified “stop time.” Each evaluation of these relationships is referred to as a time step.

- Signals represent quantities that change over time and are defined for all points in time between the block diagram’s start and stop time.
- The relationships between signals and state variables are defined by a set of equations represented by blocks. Each block consists of a set of equations (block methods). These equations define a relationship between the input signals, output signals and the state variables. Inherent in the definition of an equation is the notion of parameters, which are the coefficients found within the equation.

Creating Models

Simulink provides a graphical editor that allows you to create and connect instances of block types (see Chapter 4, “Creating a Model”) selected from libraries of block types (see the “Block Reference” in the online Simulink Help) via a library browser. Simulink provides libraries of blocks representing elementary systems that can be used as building blocks. The blocks supplied with Simulink are called built-in blocks. Simulink users can also create their own block types and use the Simulink editor to create instances of them in a diagram. Customer-defined blocks are called custom blocks.

Time

Time is an inherent component of block diagrams in that the results of a block diagram simulation change with time. Put another way, a block diagram represents the instantaneous behavior of a dynamic system. Determining a system’s behavior over time thus entails repeatedly executing the model at intervals, called time steps, from the start of the time span to the end of the time span. Simulink refers to the repeated execution of a model at successive time steps as simulating the system that the model represents. It is possible to simulate a system manually, i.e., to execute its model manually. However, this is unnecessary as the Simulink engine performs this task automatically on command from the user.

States

Typically the current values of some system, and hence model, outputs are functions of the previous values of temporal variables. Such variables are

called states. Computing a model's outputs from a block diagram hence entails saving the value of states at the current time step for use in computing the outputs at a subsequent time step. Simulink performs this task during simulation for models that define states.

Two types of states can occur in a Simulink model: discrete and continuous states. A continuous state changes continuously. Examples of continuous states are the position and speed of a car. A discrete state is an approximation of a continuous state where the state is updated (recomputed) using finite (periodic or aperiodic) intervals. An example of a discrete state would be the position of a car shown on a digital odometer where it is updated every second as opposed to continuously. In the limit, as the discrete state time interval approaches zero, a discrete state becomes equivalent to a continuous state.

Blocks implicitly define a model's states. In particular, a block that needs some or all of its previous outputs to compute its current outputs implicitly defines a set of states that need to be saved between time steps. Such a block is said to have states.

The following is a graphical representation of a block that has states.

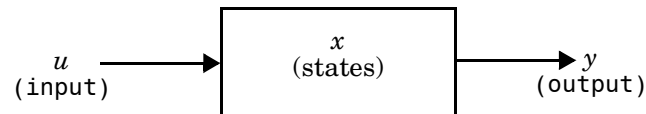

Blocks that define continuous states include the following standard Simulink blocks:

- Integrator
- State-Space
- Transfer Fcn
- Zero-Pole

The total number of a model's states is the sum of all the states defined by all its blocks. Determining the number of states in a diagram requires parsing the diagram to determine the types of blocks that it contains and then aggregating the number of states defined by each instance of a block type that defines states. Simulink performs this task during the Compilation phase of a simulation.

Continuous States

Computing a continuous state entails knowing its rate of change, or derivative. Since the rate of change of a continuous state typically itself changes continuously (i.e., is itself a state), computing the value of a continuous state at the current time step entails integration of its derivative from the start of a simulation. Thus modeling a continuous state entails representing the operation of integration and the process of computing the state's derivative at each point in time. Simulink block diagrams use Integrator blocks to indicate integration and a chain of operator blocks connected to the integrator block to represent the method for computing the state's derivative. The chain of block's connected to the Integrator's is the graphical counterpart to an ordinary differential equation (ODE).

In general, excluding simple dynamic systems, analytical methods do not exist for integrating the states of real-world dynamic systems represented by ordinary differential equations. Integrating the states requires the use of numerical methods called ODE solvers. These various methods trade computational accuracy for computational workload. Simulink comes with computerized implementations of the most common ODE integration methods and allows a user to determine which it uses to integrate states represented by Integrator blocks when simulating a system.

Computing the value of a continuous state at the current time step entails integrating its values from the start of the simulation. The accuracy of numerical integration in turn depends on the size of the intervals between time steps. In general, the smaller the time step, the more accurate the simulation. Some ODE solvers, called variable time step solvers, can automatically vary the size of the time step, based on the rate of change of the state, to achieve a specified level of accuracy over the course of a simulation. Simulink allows the user to specify the size of the time step in the case of fixed-step solvers or allow the solver to determine the step size in the case of variable-step solvers. To minimize the computation workload, the variable-step solver chooses the largest step size consistent with achieving an overall level of precision specified by the user for the most rapidly changing model state. This ensures that all model states are computed to the accuracy specified by the user.

Discrete States

Computing a discrete state requires knowing the relationship between the current time and its value at the time at which it previously changed value. Simulink refers to this relationship as the state's update function. A discrete

state depends not only on its value at the previous time step but also on the values of a model's inputs. Modeling a discrete state thus entails modeling the state's dependency on the systems' inputs at the previous time step. Simulink block diagrams use specific types of blocks, called discrete blocks, to specify update functions and chains of blocks connected to the inputs of the block's to model the state's dependency on system inputs.

As with continuous states, discrete states set a constraint on the simulation time step size. Specifically a step size must be chosen that ensure that all the sample times of the model's states are hit. Simulink assigns this task to a component of the Simulink system called a discrete solver. Simulink provides two discrete solvers: a fixed-step discrete solver and a variable-step discrete solver. The fixed-step discrete solver determines a fixed step size that hits all the sample times of all the model's discrete states, regardless of whether the states actually change value at the sample time hits. By contrast, the variable-step discrete solver varies the step size to ensure that sample time hits occur only at times when the states change value.

Modeling Hybrid Systems

A hybrid system is a system that has both discrete and continuous states. Strictly speaking a hybrid model is identified as having continuous and discrete sample times from which it follows that the model will have continuous and discrete states. Solving a model of such a system entails choosing a step size that satisfies both the precision constraint on the continuous state integration and the sample time hit constraint on the discrete states. Simulink meets this requirement by passing the next sample time hit as determined by the discrete solver as an additional constraint on the continuous solver. The continuous solver must choose a step size that advances the simulation up to but not beyond the time of the next sample time hit. The continuous solver can take a time step short of the next sample time hit to meet its accuracy constraint but it cannot take a step beyond the next sample time hit even if its accuracy constraint allows it to.

Block Parameters

Key properties of many standard blocks are parameterized. For example, the Constant value of the Simulink Constant block is a parameter. Each parameterized block has a block dialog that lets you set the values of the parameters. You can use MATLAB expressions to specify parameter values. Simulink evaluates the expressions before running a simulation. You can

change the values of parameters during a simulation. This allows you to determine interactively the most suitable value for a parameter.

A parameterized block effectively represents a family of similar blocks. For example, when creating a model, you can set the Constant value parameter of each instance of the Constant block separately so that each instance behaves differently. Because it allows each standard block to represent a family of blocks, block parameterization greatly increases the modeling power of the standard Simulink libraries.

Each time you change parameters, you change the meaning of the model. Simulink lets you modify the parameter values during execution of your model. For example, you can pause simulation, change parameter values, and continue simulation. It should be pointed out that parameter changes do not immediately occur, but are queued up and then applied at the start of the next time step during model execution. Returning to our example of the constant block, the function it defines is $signal(t) = ConstantValue$ for all time. If we were to allow the constant value to be changed immediately, then the solution at the point in time at which the change occurred would be invalid, thus we must queue the change for processing on the next time step.

Tunable Parameters

Many block parameters are tunable. A *tunable parameter* is a parameter whose value can change while Simulink is executing a model. For example, the gain parameter of the Gain block is tunable. You can alter the block's gain while a simulation is running. If a parameter is not tunable and the simulation is running, Simulink disables the dialog box control that sets the parameter. Simulink allows you to specify that all parameters in your model are nontunable except for those that you specify. This can speed up execution of large models and enable generation of faster code from your model. See “Model Parameter Configuration Dialog Box” on page 10-47 for more information.

Block Sample Times

Every Simulink block is considered to have a sample time, even continuous blocks (e.g., blocks that define continuous states, such as the Integrator block) and blocks that do not define states, such as the Gain block. Discrete blocks allows you to specify their sample times via a Sample Time parameter. Continuous blocks are considered to have an infinitesimal sample time called a continuous sample time. A block that is neither discrete or continuous is said

to have an implicit sample time that it inherits from its inputs. The implicit sample time is continuous if any of the block's inputs are continuous. Otherwise, the implicit sample time is discrete. An implicit discrete sample time is equal to the shortest input sample time if all the input sample times are integer multiples of the shortest time. Otherwise, the implicit sample time is equal to the *fundamental sample time* of the inputs, where the fundamental sample time of a set of sample times is defined as the greatest integer divisor of the set of sample times.

Simulink can optionally color code a block diagram to indicate the sample times of the blocks it contains, e.g., black (continuous), magenta (constant), yellow (hybrid), red (fastest discrete), and so on. See “Mixed Continuous and Discrete Systems” on page 2-40 for more information.

Custom Blocks

Simulink allows you to create libraries of custom blocks that you can then use in your models. You can create a custom block either graphically or programmatically. To create a custom block graphically, you draw a block diagram representing the block's behavior, wrap this diagram in an instance of the Simulink Subsystem block, and provide the block with a parameter dialog, using the Simulink block mask facility. To create a block programmatically, you create an M-file or a MEX-file that contains the block's system functions (see *Writing S-Functions* in the online Help for Simulink). The resulting file is called an S-function. You then associate the S-function with instances of the Simulink S-Function block in your model. You can add a parameter dialog to your S-Function block by wrapping it in a Subsystem block and adding the parameter dialog to the Subsystem block.

Systems and Subsystems

A Simulink block diagram can consist of layers. Each layer is defined by a subsystem. A subsystem is part of the overall block diagram and ideally has no impact on the meaning of the block diagram. Subsystems are provided primarily to help in the organization aspects a block diagram. Subsystem do not define a separate block diagram.

Simulink differentiates between two different types of subsystems virtual and nonvirtual subsystems. The main difference is that nonvirtual subsystems provide the ability to control when the contents of the subsystem are evaluated.

Flattening the Model Hierarchy

While preparing a model for execution, Simulink generates internal “systems” that are collections of block methods (equations) that are evaluated together. The semantics of time-based block diagrams doesn’t require creation of these systems. Simulink creates these internal systems as a means to manage the execution of the model. Roughly speaking, there will be one system for the top-level block diagram window which is referred to as the root system, and several lower-level system derived from the nonvirtual subsystem and other elements within the block diagram. You will see these systems within the Simulink Debugger. The act of creating these “internal” systems is often referred to as flattening the model hierarchy.

Conditionally Executed Subsystems

You can create conditionally executed subsystems that are executed only when a transition occurs on a triggering, function-call, action, or enabling input (see “Creating Conditionally Executed Subsystems” on page 4-26).

Conditionally executed subsystems are atomic. Unconditionally executed subsystems are virtual by default. You can, however, designate an unconditionally executed subsystem as atomic. This is useful if you need to ensure that the equations defined by a subsystem are evaluated “together” as a unit.

Signals

Simulink uses the term *signal* to refer to a time varying quantity that has values at all points in time. Simulink allows you to specify a wide range of signal attributes, including signal name, data type (e.g., 8-bit, 16-bit, or 32-bit integer), numeric type (real or complex), and dimensionality (one-dimensional or two-dimensional array). Many blocks can accept or output signals of any data or numeric type and dimensionality. Others impose restrictions on the attributes of the signals they can handle.

On the block diagram, you will find that the signals are represented with lines that have an arrow head. The source of the signal corresponds to the block that writes to the signal during evaluation of its block methods (equations). The destinations of the signal are blocks that read the signal during the evaluation of its block methods (equations). A good analogy of the meaning of a signal is to consider a classroom. The teacher is the one responsible for writing on the white board and the students read what is written on the white board when

they choose to. This is also true of Simulink signals, a reader of the signal (a block method) can choose to read the signal as frequently or infrequently as so desired.

Block Methods

Blocks represent multiple equations. These equations are represented as block methods within Simulink. These block methods are evaluated (executed) during the execution of a block diagram. The evaluation of these block methods is performed within a simulation loop, where each cycle through the simulation loop represent evaluation of the block diagram at a given point in time.

Method Types

Simulink assigns names to the types of functions performed by block methods. Common method types include:

- **Outputs**
Computes the outputs of a block given its inputs at the current time step and its states at the previous time step.
- **Update**
Computes the value of the block's discrete states at the current time step, given its inputs at the current time step and its discrete states at the previous time step.
- **Derivatives**
Computes the derivatives of the block's continuous states at the current time step, given the block's inputs and the values of the states at the previous time step.

Method Naming Convention

Block methods perform the same types of operations in different ways for different types of blocks. The Simulink user interface and documentation uses dot notation to indicate the specific function performed by a block method:

```
BlockType.MethodType
```

For example, Simulink refers to the method that computes the outputs of a Gain block as

```
Gain.Outputs
```

The Simulink debugger takes the naming convention one step further and uses the instance name of a block to specify both the method type and the block instance on which the method is being invoked during simulation, e.g.,

g1.Outputs

Model Methods

In addition to block methods, Simulink also provides a set of methods that compute the model's properties and its outputs. Simulink similarly invokes these methods during simulation to determine a model's properties and its outputs. The model methods generally perform their tasks by invoking block methods of the same type. For example, the model Outputs method invokes the Outputs methods of the blocks that it contains in the order specified by the model to compute its outputs. The model Derivatives method similarly invokes the Derivatives methods of the blocks that it contains to determine the derivatives of its states.

Simulating Dynamic Systems

Simulating a dynamic system refers to the process of computing a system's states and outputs over a span of time, using information provided by the system's model. Simulink simulates a system when you choose **Start** from the model editor's **Simulation** menu, with the system's model open.

A Simulink component called the Simulink Engine responds to a Start command, performing the following steps.

Model Compilation

First, the Simulink engine invokes the model compiler. The model compiler converts the model to an executable form, a process called compilation. In particular, the compiler

- Evaluates the model's block parameter expressions to determine their values.
- Determines signal attributes, e.g., name, data type, numeric type, and dimensionality, not explicitly specified by the model and checks that each block can accept the signals connected to its inputs.
- Simulink uses a process called attribute propagation to determine unspecified attributes. This process entails propagating the attributes of a source signal to the inputs of the blocks that it drives.
- Performs block reduction optimizations.
- Flattens the model hierarchy by replacing virtual subsystems with the blocks that they contain (see "Solvers" on page 2-17).
- Sorts the blocks into the order in which they need to be executed during the execution phase (see "Solvers" on page 2-17).
- Determines the sample times of all blocks in the model whose sample times you did not explicitly specify.

Determining Block Update Order

During a simulation, Simulink updates the states and outputs of a model's blocks once per time step. The order in which the blocks are updated is therefore critical to the validity of the results. In particular, if a block's outputs are a function of its inputs at the current time step, the block must be updated after the blocks that drive its inputs. Otherwise, the block's outputs will be

invalid. Simulink sorts the blocks into the correct order during the model initialization phase.

Direct-Feedthrough Ports. In order to create a valid update ordering, Simulink categorizes a block's input ports according to the relationship of outputs to inputs. An input port whose current value determines the current value of one of the block's outputs is called a *direct-feedthrough* port. Examples of blocks that have direct-feedthrough ports include the Gain, Product, and Sum blocks. Examples of blocks that have non-direct-feedthrough inputs include the Integrator block (its output is a function purely of its state), the Constant block (it does not have an input), and the Memory block (its output is dependent on its input in the previous time step).

Block Sorting Rules. Simulink uses the following basic update rules to sort the blocks:

- Each block must be updated before any of the blocks whose direct-feedthrough ports it drives.

This rule ensures that the direct-feedthrough inputs to blocks will be valid when the blocks are updated.

- Blocks that do not have direct feedthrough inputs can be updated in any order as long as they are updated before any blocks whose direct-feedthrough inputs they drive.

Putting all blocks that do not have direct-feedthrough ports at the head of the update list in any order satisfies this rule. It thus allows Simulink to ignore these blocks during the sorting process.

The result of applying these rules is an update list in which blocks without direct feedthrough ports appear at the head of the list in no particular order followed by blocks with direct-feedthrough ports in the order required to supply valid inputs to the blocks they drive.

During the sorting process, Simulink checks for and flags the occurrence of algebraic loops, that is, signal loops in which a direct-feedthrough output of a block is connected directly or indirectly to the corresponding direct-feedthrough input of the block. Such loops seemingly create a deadlock condition, because Simulink needs the value of the direct-feedthrough input to compute the output. However, an algebraic loop can represent a set of simultaneous algebraic equations (hence the name) where the block's input and output are the unknowns. Further, these equations can have valid

solutions at each time step. Accordingly, Simulink assumes that loops involving direct-feedthrough ports do, in fact, represent a solvable set of algebraic equations and attempts to solve them each time the block is updated during a simulation. For more information, see “Algebraic Loops” on page 2-24.

Link Phase

In this phase, the Simulink Engine allocates memory needed for working areas (signals, states, and run-time parameters) for execution of the block diagram. It also allocates and initializes memory for data structures that store run-time information for each block. For built-in blocks, the principal run-time data structure for a block is called the SimBlock. It stores pointers to a block’s input and output buffers and state and work vectors.

Method Execution Lists

In the Link phase, the Simulink engine also creates method execution lists. These lists list the most efficient order in which to execute a model’s block methods to compute its outputs. Simulink uses the sorted lists generated during the Compile phase to construct the method execution lists.

Block Priorities

Simulink allows you to assign update priorities to blocks (see “Assigning Block Priorities” on page 5-20). Simulink executes the output methods of higher priority blocks before those of lower priority blocks. Simulink honors the priorities only if they are consistent with its block sorting rules.

Simulation Loop Phase

The simulation now enters the simulation loop phase. In this phase, the Simulink engine successively computes the states and outputs of the system at intervals from the simulation start time to the finish time, using information provided by the model. The successive time points at which the states and outputs are computed are called time steps. The length of time between steps is called the step size. The step size depends on the type of solver (see “Solvers” on page 2-17) used to compute the system’s continuous states, the system’s fundamental sample time (see “Modeling and Simulating Discrete Systems” on page 2-31), and whether the system’s continuous states have discontinuities (see “Zero-Crossing Detection” on page 2-19).

The Simulation Loop phase has two subphases: the Loop Initialization phase and the Loop Iteration phase. The initialization phase occurs once, at the start of the loop. The iteration phase is repeated once per time step from the simulation start time to the simulation stop time.

At the start of the simulation, the model specifies the initial states and outputs of the system to be simulated. At each step, Simulink computes new values for the system's inputs, states, and outputs and updates the model to reflect the computed values. At the end of the simulation, the model reflects the final values of the system's inputs, states, and outputs. Simulink provides data display and logging blocks. You can display and/or log intermediate results by including these blocks in your model.

Loop Iteration

At each time step, the Simulink Engine

1 Computes the model's outputs.

The Simulink Engine initiates this step by invoking the Simulink model Outputs method. The model Outputs method in turn invokes the model system Outputs method, which invokes the Outputs methods of the blocks that the model contains in the order specified by the Outputs method execution lists generated in the Link phase of the simulation (see "Solvers" on page 2-17).

The system Outputs method passes the following arguments to each block Outputs method: a pointer to the block's data structure and to its SimBlock structure. The SimBlock data structures point to information that the Outputs method needs to compute the block's outputs, including the location of its input buffers and its output buffers.

2 Computes the model's states.

The Simulink Engine computes a model's states by invoking a solver. Which solver it invokes depends on whether the model has no states, only discrete states, only continuous states, or both continuous and discrete states.

If the model has only discrete states, the Simulink Engine invokes the discrete solver selected by the user. The solver computes the size of the time step needed to hit the model's sample times. It then invokes the Update

method of the model. The model Update method invokes the Update method of its system, which invokes the Update methods of each of the blocks that the system contains in the order specified by the Update method lists generated in the Link phase.

If the model has only continuous states, the Simulink Engine invokes the continuous solver specified by the model. Depending on the solver, the solver either in turn calls the Derivatives method of the model once or enters a subcycle of minor time steps where the solver repeatedly calls the model's Outputs methods and Derivatives methods to compute the model's outputs and derivatives at successive intervals within the major time step. This is done to increase the accuracy of the state computation. The model Outputs method and Derivatives methods in turn invoke their corresponding system methods, which invoke the block Outputs and Derivatives in the order specified by the Outputs and Derivatives methods execution lists generated in the Link phase.

3 Optionally checks for discontinuities in the continuous states of blocks.

Simulink uses a technique called zero-crossing detection to detect discontinuities in continuous states. See “Zero-Crossing Detection” on page 2-19 for more information.

4 Computes the time for the next time step.

Simulink repeats steps 1 through 4 until the simulation stop time is reached.

Solvers

Simulink simulates a dynamic system by computing its states at successive time steps over a specified time span, using information provided by the model. The process of computing the successive states of a system from its model is known as solving the model. No single method of solving a model suffices for all systems. Accordingly, Simulink provides a set of programs, known as *solvers*, that each embody a particular approach to solving a model. The **Configuration Parameters** dialog box allows you to choose the solver most suitable for your model (see “Choosing a Solver Type” on page 10-7).

Fixed-Step Solvers Versus Variable-Step Solvers

Simulink solvers fall into two basic categories: fixed-step and variable-step.

Fixed-step solvers solve the model at regular time intervals from the beginning to the end of the simulation. The size of the interval is known as the step size. You can specify the step size or let the solver choose the step size. Generally, decreasing the step size increases the accuracy of the results while increasing the time required to simulate the system.

Variable-step solvers vary the step size during the simulation, reducing the step size to increase accuracy when a model's states are changing rapidly and increasing the step size to avoid taking unnecessary steps when the model's states are changing slowly. Computing the step size adds to the computational overhead at each step but can reduce the total number of steps, and hence simulation time, required to maintain a specified level of accuracy for models with rapidly changing or piecewise continuous states.

Continuous Versus Discrete Solvers

Simulink provides both continuous and discrete solvers.

Continuous solvers use numerical integration to compute a model's continuous states at the current time step from the states at previous time steps and the state derivatives. Continuous solvers rely on the model's blocks to compute the values of the model's discrete states at each time step.

Mathematicians have developed a wide variety of numerical integration techniques for solving the ordinary differential equations (ODEs) that represent the continuous states of dynamic systems. Simulink provides an extensive set of fixed-step and variable-step continuous solvers, each implementing a specific ODE solution method (see "Choosing a Solver Type" on page 10-7).

Discrete solvers exist primarily to solve purely discrete models. They compute the next simulation time step for a model and nothing else. They do not compute continuous states and they rely on the model's blocks to update the model's discrete states.

Note You can use a continuous solver, but not a discrete solver, to solve a model that contains both continuous and discrete states. This is because a discrete solver does not handle continuous states. If you select a discrete solver for a continuous model, Simulink disregards your selection and uses a continuous solver instead when solving the model.

Simulink provides two discrete solvers, a fixed-step discrete solver and a variable-step discrete solver. The fixed-step solver by default chooses a step size and hence simulation rate fast enough to track state changes in the fastest block in your model. The variable-step solver adjusts the simulation step size to keep pace with the actual rate of discrete state changes in your model. This can avoid unnecessary steps and hence shorten simulation time for multirate models (see “Determining Step Size for Discrete Systems” on page 2-36 for more information).

Minor Time Steps

Some continuous solvers subdivide the simulation time span into major and minor time steps, where a minor time step represents a subdivision of the major time step. The solver produces a result at each major time step. It uses results at the minor time steps to improve the accuracy of the result at the major time step.

Zero-Crossing Detection

When simulating a dynamic system, Simulink checks for discontinuities in the system’s state variables at each time step, using a technique known as zero-crossing detection. If Simulink detects a discontinuity within the current time step, it determines the precise time at which the discontinuity occurs and takes additional time steps before and after the discontinuity. This section explains why zero-crossing detection is important and how it works.

Discontinuities in state variables often coincide with significant events in the evolution of a dynamic system. For example, the instant when a bouncing ball hits the floor coincides with a discontinuity in its position. Because discontinuities often indicate a significant change in a dynamic system, it is important to simulate points of discontinuity precisely. Otherwise, a simulation could lead to false conclusions about the behavior of the system under investigation. Consider, for example, a simulation of a bouncing ball. If

the point at which the ball hits the floor occurs between simulation steps, the simulated ball appears to reverse position in midair. This might lead an investigator to false conclusions about the physics of the bouncing ball.

To avoid such misleading conclusions, it is important that simulation steps occur at points of discontinuity. A simulator that relies purely on solvers to determine simulation times cannot efficiently meet this requirement. Consider, for example, a fixed-step solver. A fixed-step solver computes the values of state variables at integral multiples of a fixed step size. However, there is no guarantee that a point of discontinuity will occur at an integral multiple of the step size. You could reduce the step size to increase the probability of hitting a discontinuity, but this would greatly increase the execution time.

A variable-step solver appears to offer a solution. A variable-step solver adjusts the step size dynamically, increasing the step size when a variable is changing slowly and decreasing the step size when the variable changes rapidly. Around a discontinuity, a variable changes extremely rapidly. Thus, in theory, a variable-step solver should be able to hit a discontinuity precisely. The problem is that to locate a discontinuity accurately, a variable-step solver must again take many small steps, greatly slowing down the simulation.

How Zero-Crossing Detection Works

Simulink uses a technique known as zero-crossing detection to address this problem. With this technique, a block can register a set of zero-crossing variables with Simulink, each of which is a function of a state variable that can have a discontinuity. The zero-crossing function passes through zero from a positive or negative value when the corresponding discontinuity occurs. At the end of each simulation step, Simulink asks each block that has registered zero-crossing variables to update the variables. Simulink then checks whether any variable has changed sign since the last step. Such a change indicates that a discontinuity occurred in the current time step.

If any zero crossings are detected, Simulink interpolates between the previous and current values of each variable that changed sign to estimate the times of the zero crossings (e.g., discontinuities). Simulink then steps up to and over each zero crossing in turn. In this way, Simulink avoids simulating exactly at the discontinuity, where the value of the state variable might be undefined.

Zero-crossing detection enables Simulink to simulate discontinuities accurately without resorting to excessively small step sizes. Many Simulink

blocks support zero-crossing detection. The result is fast and accurate simulation of all systems, including systems with discontinuities.

Implementation Details

An example of a Simulink block that uses zero crossings is the Saturation block. Zero crossings detect these state events in the Saturation block:

- The input signal reaches the upper limit.
- The input signal leaves the upper limit.
- The input signal reaches the lower limit.
- The input signal leaves the lower limit.

Simulink blocks that define their own state events are considered to have *intrinsic zero crossings*. If you need explicit notification of a zero-crossing event, use the Hit Crossing block. See “Blocks with Zero Crossings” on page 2-23 for a list of blocks that incorporate zero crossings.

The detection of a state event depends on the construction of an internal zero-crossing signal. This signal is not accessible by the block diagram. For the Saturation block, the signal that is used to detect zero crossings for the upper limit is $zcSignal = UpperLimit - u$, where u is the input signal.

Zero-crossing signals have a direction attribute, which can have these values:

- *rising* – A zero crossing occurs when a signal rises to or through zero, or when a signal leaves zero and becomes positive.
- *falling* – A zero crossing occurs when a signal falls to or through zero, or when a signal leaves zero and becomes negative.
- *either* – A zero crossing occurs if either a rising or falling condition occurs.

For the Saturation block’s upper limit, the direction of the zero crossing is *either*. This enables the entering and leaving saturation events to be detected using the same zero-crossing signal.

If the error tolerances are too large, it is possible for Simulink to fail to detect a zero crossing. For example, if a zero crossing occurs within a time step, but the values at the beginning and end of the step do not indicate a sign change, the solver steps over the crossing without detecting it.

The following figure shows a signal that crosses zero. In the first instance, the integrator steps over the event. In the second, the solver detects the event.

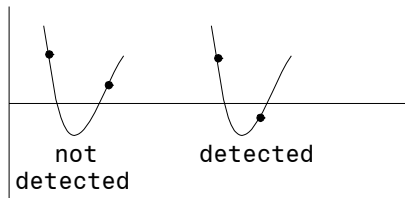

If you suspect this is happening, tighten the error tolerances to ensure that the solver takes small enough steps. For more information, see “Maximum order” on page 10-35.

Note Using the Refine output option (see “Output options” on page 10-42) does not help locate the missed zero crossings. You should alter the maximum step size or output times.

Caveat

It is possible to create models that exhibit high-frequency fluctuations about a discontinuity (chattering). Such systems typically are not physically realizable; a massless spring, for example. Because chattering causes repeated detection of zero crossings, the step sizes of the simulation become very small, essentially halting the simulation.

If you suspect that this behavior applies to your model, you can use the **Zero crossing control** option on the **Solver** pane of the **Configuration Parameters** dialog box (see “Zero crossing control” on page 10-33) to disable zero-crossing detection. Although disabling zero-crossing detection can alleviate the symptoms of this problem, you no longer benefit from the increased accuracy that zero-crossing detection provides. A better solution is to try to identify the source of the underlying problem in the model.

Blocks with Zero Crossings

The following table lists blocks that use zero crossings and explains how the blocks use the zero crossings:

Block	Description of Zero Crossing
Abs	One: to detect when the input signal crosses zero in either the rising or falling direction.
Backlash	Two: one to detect when the upper threshold is engaged, and one to detect when the lower threshold is engaged.
Dead Zone	Two: one to detect when the dead zone is entered (the input signal minus the lower limit), and one to detect when the dead zone is exited (the input signal minus the upper limit).
Hit Crossing	One: to detect when the input crosses the threshold.
Integrator	If the reset port is present, to detect when a reset occurs. If the output is limited, there are three zero crossings: one to detect when the upper saturation limit is reached, one to detect when the lower saturation limit is reached, and one to detect when saturation is left.
MinMax	One: for each element of the output vector, to detect when an input signal is the new minimum or maximum.
Relay	One: if the relay is off, to detect the switch on point. If the relay is on, to detect the switch off point.
Relational Operator	One: to detect when the output changes.
Saturation	Two: one to detect when the upper limit is reached or left, and one to detect when the lower limit is reached or left.
Sign	One: to detect when the input crosses through zero.
Step	One: to detect the step time.

Block	Description of Zero Crossing (Continued)
Subsystem	For conditionally executed subsystems: one for the enable port if present, and one for the trigger port, if present.
Switch	One: to detect when the switch condition occurs.

Algebraic Loops

Some Simulink blocks have input ports with *direct feedthrough*. This means that the output of these blocks cannot be computed without knowing the values of the signals entering the blocks at these input ports. Some examples of blocks with direct feedthrough inputs are as follows:

- The Math Function block
- The Gain block
- The Integrator block's initial condition ports
- The Product block
- The State-Space block when there is a nonzero D matrix
- The Sum block
- The Transfer Fcn block when the numerator and denominator are of the same order
- The Zero-Pole block when there are as many zeros as poles

An *algebraic loop* generally occurs when an input port with direct feedthrough is driven by the output of the same block, either directly, or by a feedback path through other blocks with direct feedthrough. An example of an algebraic loop is this simple scalar loop.

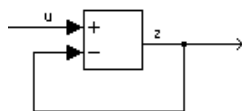

Mathematically, this loop implies that the output of the Sum block is an algebraic state z constrained to equal the first input u minus z (i.e. $z = u - z$). The solution of this simple loop is $z = u/2$, but most algebraic loops cannot be solved by inspection.

It is easy to create vector algebraic loops with multiple algebraic state variables $z1$, $z2$, etc., as shown in this model.

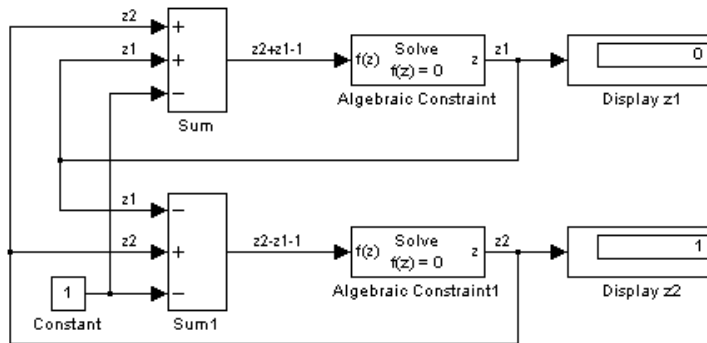

The Algebraic Constraint block is a convenient way to model algebraic equations and specify initial guesses. The Algebraic Constraint block constrains its input signal $F(z)$ to zero and outputs an algebraic state z . This block outputs the value necessary to produce a zero at the input. The output must affect the input through some feedback path. You can provide an initial guess of the algebraic state value in the block's dialog box to improve algebraic loop solver efficiency.

A scalar algebraic loop represents a scalar algebraic equation or constraint of the form $F(z) = 0$, where z is the output of one of the blocks in the loop and the function F consists of the feedback path through the other blocks in the loop to the input of the block. In the simple one-block example shown on the previous page, $F(z) = z - (u - z)$. In the vector loop example shown above, the equations are

$$\begin{aligned} z2 + z1 - 1 &= 0 \\ z2 - z1 - 1 &= 0 \end{aligned}$$

Algebraic loops arise when a model includes an algebraic constraint $F(z) = 0$. This constraint might arise as a consequence of the physical interconnectivity of the system you are modeling, or it might arise because you are specifically trying to model a differential/algebraic system (DAE).

When a model contains an algebraic loop, Simulink calls a loop solving routine at each time step. The loop solver performs iterations to determine the solution

to the problem (if it can). As a result, models with algebraic loops run slower than models without them.

To solve $F(z) = 0$, the Simulink loop solver uses Newton's method with weak line search and rank-one updates to a Jacobian matrix of partial derivatives. Although the method is robust, it is possible to create loops for which the loop solver will not converge without a good initial guess for the algebraic states z . You can specify an initial guess for a line in an algebraic loop by placing an IC block (which is normally used to specify an initial condition for a signal) on that line. As shown above, another way to specify an initial guess for a line in an algebraic loop is to use an Algebraic Constraint block.

Whenever possible, use an IC block or an Algebraic Constraint block to specify

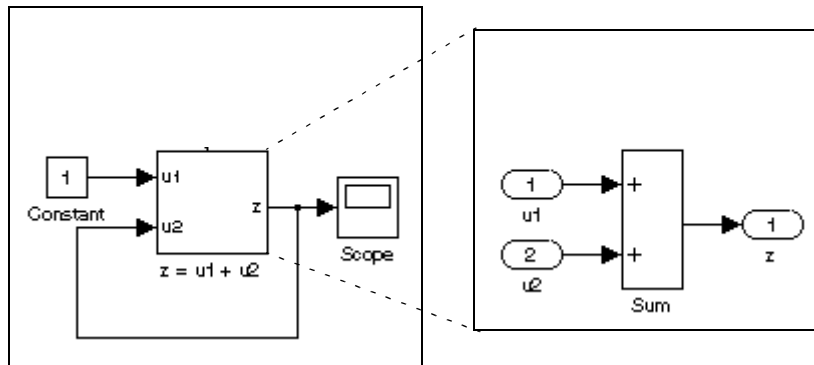

In this case, the input at the $u2$ port of the adder subsystem is equal to the subsystem's output at the current time step for every time step. The mathematical representation of this system

$$z = z + 1$$

reveals that it has no mathematically valid solution.

Highlighting Algebraic Loops

You can cause Simulink to highlight algebraic loops when you update, simulate, or debug a model. Use the `ashow` command to highlight algebraic loops when debugging a model.

To cause Simulink to highlight algebraic loops that it detects when updating or simulating a model, set the Algebraic loop diagnostic on the **Diagnostics** pane of the **Configuration Parameters** dialog box to Error (see "The

Configuration Parameters Dialog Box” on page 10-30 for more information). This causes Simulink to display an error dialog (the Diagnostics Viewer) and recolor portions of the diagram that represent the algebraic loops that it detects. Simulink uses red to color the blocks and lines that constitute the loops. Closing the error dialog restores the diagram to its original colors.

For example, the following figure shows the block diagram of the `hydcyl1` demo model in its original colors.

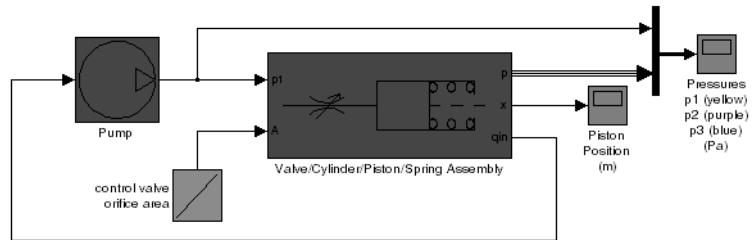

The following figure shows the diagram after updating when the Algebraic loop diagnostic is set to Error.

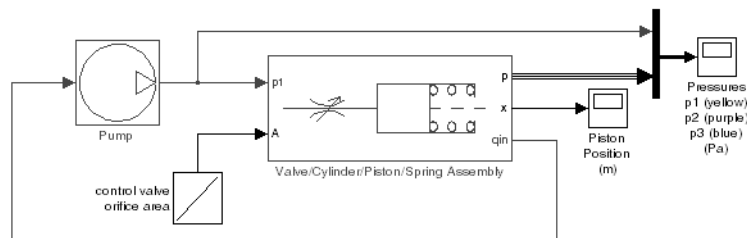

In this example, Simulink has colored the algebraic loop red, making it stand out from the rest of the diagram.

Eliminating Algebraic Loops

Simulink can eliminate some algebraic loops that include any of following types of blocks:

- Atomic Subsystem
- Enabled Subsystem
- Model

To enable automatic algebraic loop elimination for a loop involving a particular instance of an Atomic Subsystem or Enabled Subsystem block, select the **Minimize algebraic loop occurrences** parameter on the block's parameters dialog box. To enable algebraic loop elimination for a loop involving a Model block, check the **Minimize algebraic loop occurrences** parameter on the **Model Referencing** configuration parameters dialog (see "Model Referencing Pane" on page 10-67) of the model referenced by the Model block. If a loop includes more than one instance of these blocks, you should enable algebraic loop elimination for all of them, including nested blocks.

The Simulink **Minimize algebraic loop** solver diagnostic allows you to specify the action Simulink should take, for example, display a warning message, if it is unable to eliminate an algebraic loop involving a block for which algebraic loop elimination is enabled. See "The Diagnostics Pane" on page 10-48 for more information.

Algebraic loop minimization is off by default because it is incompatible with conditional input branch optimization in Simulink (see "The Optimization Pane" on page 10-43) and with single output/update function optimization in Real-Time Workshop[®]. If you need these optimizations for an atomic or enabled subsystem or referenced model involved in an algebraic loop, you must eliminate the algebraic loop yourself.

As an example of the ability of Simulink to eliminate algebraic loops, consider the following model.

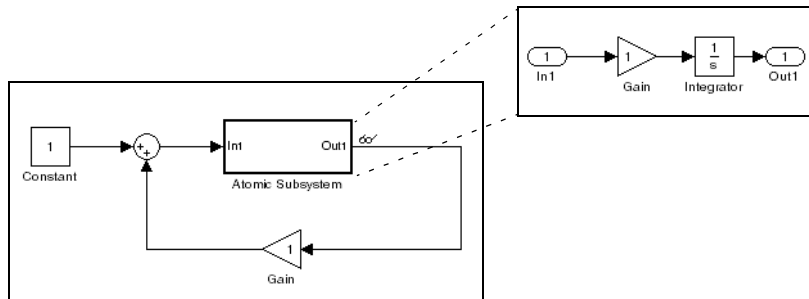

Simulating this model with the solver's Algebraic Loop diagnostic set to error (see "The Diagnostics Pane" on page 10-48) reveals that this model contains an algebraic loop involving its atomic subsystem.

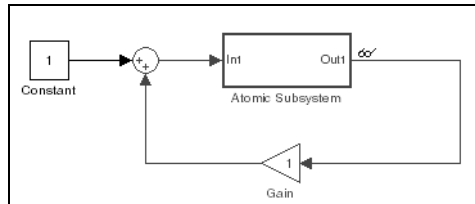

Checking the atomic subsystem's **Minimize algebraic loop occurrences** parameter causes Simulink to eliminate the algebraic loop from the compiled version of the model.

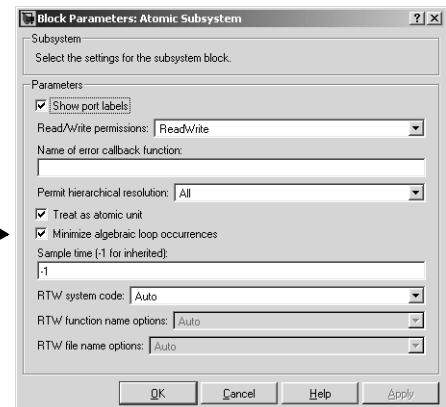
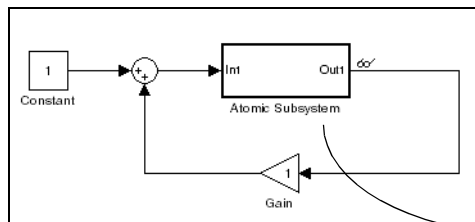

As a result, the model now simulates without error.

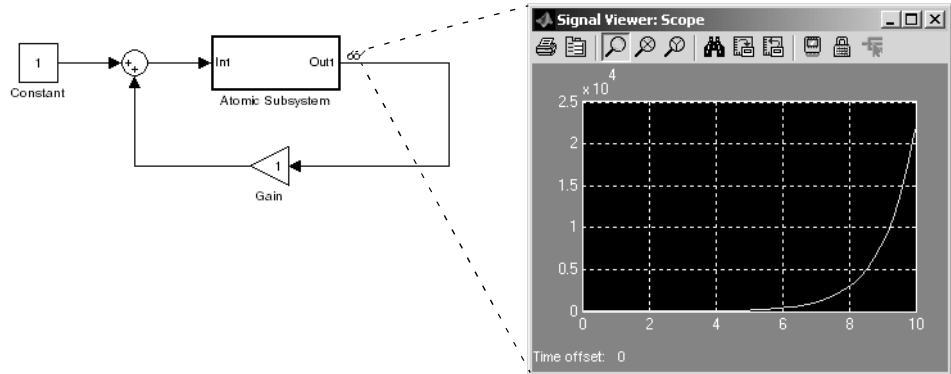

Note that Simulink is able to eliminate the algebraic loop involving this model's atomic subsystem because the atomic subsystem contains a block with a port that does not have direct feed through, i.e., the Integrator block.

If you remove the Integrator block from the atomic subsystem, Simulink is unable to eliminate the algebraic loop. Hence, attempting to simulate the model results in an error.

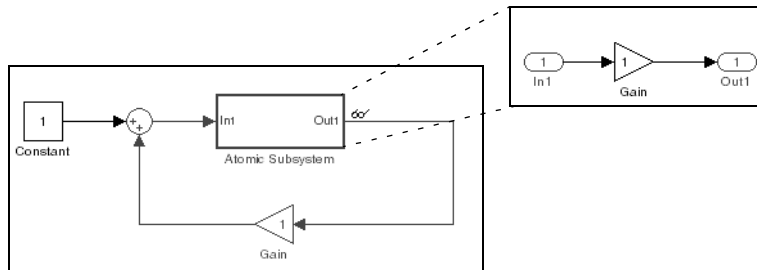

Modeling and Simulating Discrete Systems

Simulink has the ability to simulate discrete (sampled data) systems, including systems whose components operate at different rates (*multirate systems*) and systems that mix discrete and continuous components (*hybrid systems*). This capability stems from two key Simulink features:

- **SampleTime block parameter**

Some Simulink blocks have a `SampleTime` parameter that you can use to specify the block's sample time, i.e., the rate at which it executes during simulation. All blocks have either an explicit or implicit sample time parameter. Continuous blocks are examples of blocks that have an implicit (continuous) sample time. It is possible for a block to have multiple sample times as provided with blocksets such as the Signal Processing Blockset or created by a user using the S-Function block.

- **Sample-time inheritance**

Most standard Simulink blocks can inherit their sample time from the blocks connected to their inputs. Exceptions include blocks in the Continuous library and blocks that do not have inputs (e.g., blocks from the Sources library). In some cases, source blocks can inherit the sample time of the block connected to its input.

The ability to specify sample times on a block-by-block basis, either directly through the `SampleTime` parameter or indirectly through inheritance, enables you to model systems containing discrete components operating at different rates and hybrid systems containing discrete and continuous components.

Specifying Sample Time

Simulink allows you to specify the sample time of any block that has a `SampleTime` parameter. You can use the block's parameter dialog box to set this parameter. You do this by entering the sample time in the **Sample time** field on the dialog box. You can enter either the sample time alone or a vector whose first element is the sample time and whose second element is an offset: $[T_s, T_o]$. Various values of the sample time and offset have special meanings.

The following table summarizes valid values for this parameter and how Simulink interprets them to determine a block's sample time.

Sample Time	Usage
$[T_s, T_o]$ $0 > T_s < T_{sim}$ $ T_o < T_p$	<p>Specifies that updates occur at simulation times</p> $t_n = n * T_s + T_o $ <p>where n is an integer in the range $1..T_{sim}/T_s$ and T_{sim} is the length of the simulation. Blocks that have a sample time greater than 0 are said to have a <i>discrete sample time</i>.</p> <p>The offset allows you to specify that Simulink update the block later in the sample interval than other blocks operating at the same rate.</p>
$[0, 0], 0$	<p>Specifies that updates occur at every major and minor time step. A block that has a sample time of 0 is said to have a <i>continuous sample time</i>.</p>
$[0, 1]$	<p>Specifies that updates occur only at major time steps, skipping minor time steps (see “Minor Time Steps” on page 2-19). This setting avoids unnecessary computations for blocks whose sample time cannot change between major time steps. The sample time of a block that executes only at major time steps is said to be <i>fixed in minor time step</i>.</p>

Sample Time	Usage
[-1, 0], -1	<p>If the block is not in a triggered subsystem, this setting specifies that the block inherits its sample time from the block connected to its input (inheritance) or, in some cases, from the block connected to its output (back inheritance). If the block is in a triggered subsystem, you must set the SampleTime parameter to this setting.</p> <p>Note that specifying sample-time inheritance for a source block can cause Simulink to assign an inappropriate sample time to the block if the source drives more than one block. For this reason, you should avoid specifying sample-time inheritance for source blocks. If you do, Simulink displays a warning message when you update or simulate the model.</p>
inf	<p>The meaning of this sample time depends on whether the active model configuration's inline parameters optimization (see "Inline parameters" on page 10-44) is enabled. If the inline parameters optimization is enabled, <code>inf</code> signifies that the block's output can never change (see "Invariant Constants" on page 2-39). This speeds up simulation and the generated code by eliminating the need to recompute the block's output at each time step. If the inline parameters optimization is disabled or the block with <code>inf</code> sample time drives an output port of a conditionally executed subsystem, Simulink treats <code>inf</code> as <code>-1</code>, i.e., as inherited sample time. This allows you to tune the block's parameters during simulation.</p>

Changing a Block's Sample Time

You cannot change the `SampleTime` parameter of a block while a simulation is running. If you want to change a block's sample time, you must stop and restart the simulation for the change to take effect.

Compiled Sample Time

During the compilation phase of a simulation, Simulink determines the sample time of the block from its `SampleTime` parameter (if it has a `SampleTime` parameter), sample-time inheritance, or block type (Continuous blocks always have a continuous sample time). It is this compiled sample time that determines the sample rate of a block during simulation. You can determine the compiled sample time of any block in a model by first updating the model and then getting the block's `CompiledSampleTime` parameter, using the `get_param` command.

Purely Discrete Systems

Purely discrete systems can be simulated using any of the solvers; there is no difference in the solutions. To generate output points only at the sample hits, choose one of the discrete solvers.

Multirate Systems

Multirate systems contain blocks that are sampled at different rates. These systems can be modeled with discrete blocks or with both discrete and continuous blocks. For example, consider this simple multirate discrete model.

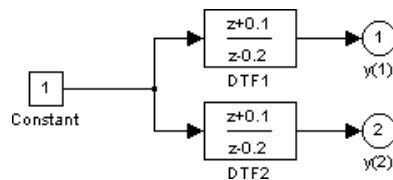

For this example the DTF1 Discrete Transfer Fcn block's **Sample time** is set to $[1 \ 0.1]$, which gives it an offset of 0.1. The DTF2 Discrete Transfer Fcn block's **Sample time** is set to 0.7, with no offset.

Starting the simulation and plotting the outputs using the stairs function

```
[t,x,y] = sim('multirate', 3);
stairs(t,y)
```

produces this plot

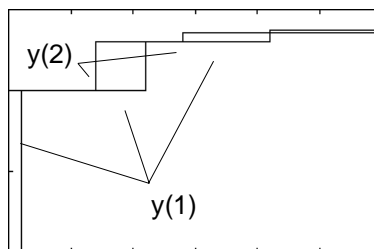

For the DTF1 block, which has an offset of 0.1, there is no output until $t = 0.1$. Because the initial conditions of the transfer functions are zero, the output of DTF1, $y(1)$, is zero before this time.

Determining Step Size for Discrete Systems

Simulating a discrete system requires that the simulator take a simulation step at every *sample time hit*, that is, at integer multiples of the system's shortest sample time. Otherwise, the simulator might miss key transitions in the system's states. Simulink avoids this by choosing a simulation step size to ensure that steps coincide with sample time hits. The step size that Simulink chooses depends on the system's fundamental sample time and the type of solver used to simulate the system.

The *fundamental sample time* of a discrete system is the greatest integer divisor of the system's actual sample times. For example, suppose that a system has sample times of 0.25 and 0.5 second. The fundamental sample time in this case is 0.25 second. Suppose, instead, the sample times are 0.5 and 0.75 second. In this case, the fundamental sample time is again 0.25 second.

You can direct Simulink to use either a fixed-step or a variable-step discrete solver to solve a discrete system. A fixed-step solver sets the simulation step size equal to the discrete system's fundamental sample time. A variable-step solver varies the step size to equal the distance between actual sample time hits. The following diagram illustrates the difference between a fixed-step and a variable-size solver.

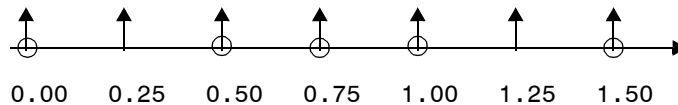

Fixed-Step Solver

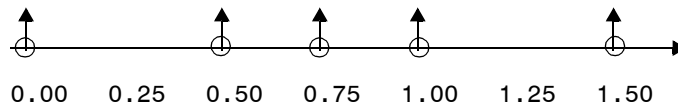

Variable-Step Solver

In the diagram, arrows indicate simulation steps and circles represent sample time hits. As the diagram illustrates, a variable-step solver requires fewer simulation steps to simulate a system, if the fundamental sample time is less than any of the actual sample times of the system being simulated. On the other hand, a fixed-step solver requires less memory to implement and is faster if one of the system's sample times is fundamental. This can be an advantage in applications that entail generating code from a Simulink model (using Real-Time Workshop[®]).

Sample Time Propagation

When updating a model's diagram, for example, at the beginning of a simulation, Simulink uses a process called sample time propagation to determine the sample times of blocks that inherit their sample times. The figure below illustrates a Discrete Filter block with a sample time of T_s driving a Gain block.

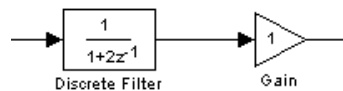

Because the Gain block's output is simply the input multiplied by a constant, its output changes at the same rate as the filter. In other words, the Gain block has an effective sample rate equal to that of the filter's sample rate. This is the fundamental mechanism behind sample time propagation in Simulink.

Simulink assigns an inherited sample time to a block based on the sample times of the blocks connected to its inputs. If all the inputs have the same sample time, Simulink assigns that sample time to the block. If the inputs have different sample times, if all sample times are integer multiples of the fastest sample time, the block is assigned the sample time of the fastest input. If a variable-step solver is being used, the block is assigned the continuous sample time. If a fixed-step solver is being used and the greatest common divisor of the sample times (the fundamental sample time) can be computed, it is used. Otherwise continuous is used.

Note A Model block can inherit its sample time from its inputs only if the inputs and outputs of the model that it references do not depend on the sample time (see “Model Block Sample Times” on page 4-61 for more information).

Under some circumstances, Simulink also back propagates sample times to source blocks if it can do so without affecting the output of a simulation. For instance, in the model below, Simulink recognizes that the Signal Generator block is driving a Discrete-Time Integrator block, so it assigns the Signal Generator block and the Gain block the same sample time as the Discrete-Time Integrator block.

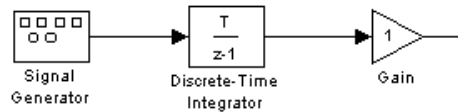

You can verify this by selecting **Sample Time Colors** from the Simulink **Format** menu and noting that all blocks are colored red. Because the Discrete-Time Integrator block only looks at its input at its sample times, this change does not affect the outcome of the simulation but does result in a performance improvement.

Replacing the Discrete-Time Integrator block with a continuous Integrator block, as shown below, and recoloring the model by choosing **Update diagram** from the **Edit** menu cause the Signal Generator and Gain blocks to change to continuous blocks, as indicated by their being colored black.

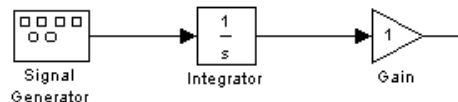

Invariant Constants

Simulink by default assigns Constant blocks a sample time of infinity, also referred to as a *constant sample time*. This means that the outputs of any blocks that inherit a constant sample time from a Constant block do not change during the simulation unless the parameters are explicitly modified by the model user.

For example, in this model, both the Constant and Gain blocks have constant sample time.

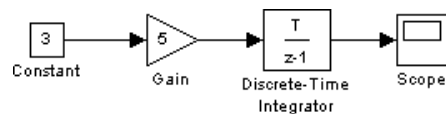

Because Simulink supports the ability to change block parameters during a simulation, all blocks, even blocks having constant sample time, must generate their output at the model's effective sample time.

Note You can determine which blocks have constant sample time by selecting **Sample Time Colors** from the **Format** menu. Blocks having constant sample time are colored magenta.

Because of this feature, *all* blocks compute their output at each sample time hit, or, in the case of purely continuous systems, at every simulation step. For blocks having constant sample time whose parameters do not change during a simulation, evaluating these blocks during the simulation is inefficient and slows down the simulation.

You can set the inline parameters option (see “Inline parameters” on page 10-44) to remove all blocks having constant sample times from the simulation “loop.” The effect of this feature is twofold. First, parameters for these blocks cannot be changed during a simulation. Second, simulation speed is improved. The speed improvement depends on model complexity, the number of blocks with constant sample time, and the effective sampling rate of the simulation.

Note Simulink displays an error if you connect a Constant, Model, or S-Function block with constant sample time to the output port of a conditionally executed subsystem. To avoid the error, either change the sample time of the block to a nonconstant sample time or insert a Signal Conversion block between the block with constant sample time and the output port.

Mixed Continuous and Discrete Systems

Mixed continuous and discrete systems are composed of both sampled and continuous blocks. Such systems can be simulated using any of the integration methods, although certain methods are more efficient and accurate than others. For most mixed continuous and discrete systems, the Runge-Kutta variable-step methods, `ode23` and `ode45`, are superior to the other methods in terms of efficiency and accuracy. Because of discontinuities associated with the sample and hold of the discrete blocks, the `ode15s` and `ode113` methods are not recommended for mixed continuous and discrete systems.

Simulink Basics

The following sections explain how to perform basic Simulink tasks.

Starting Simulink (p. 3-2)	How to start Simulink.
Opening Models (p. 3-4)	How to open a Simulink model.
Entering Simulink Commands (p. 3-5)	Explains various ways to execute Simulink commands.
Simulink Windows (p. 3-7)	Guide to the features of the windows used to display Simulink models and block libraries.
Saving a Model (p. 3-9)	How to save a Simulink model to disk.
Printing a Block Diagram (p. 3-12)	How to print a Simulink block diagram.
Generating a Model Report (p. 3-16)	How to generate an HTML report on a model's structure and content.
Summary of Mouse and Keyboard Actions (p. 3-19)	Lists key combinations and mouse actions that you can use to execute Simulink commands.
Ending a Simulink Session (p. 3-22)	How to end a Simulink session.

Starting Simulink

To start Simulink, you must first start MATLAB. Consult your MATLAB documentation for more information. You can then start Simulink in two ways:

- Click the Simulink icon  on the MATLAB toolbar.
- Enter the `simulink` command at the MATLAB prompt.

On Microsoft Windows platforms, starting Simulink displays the Simulink Library Browser.

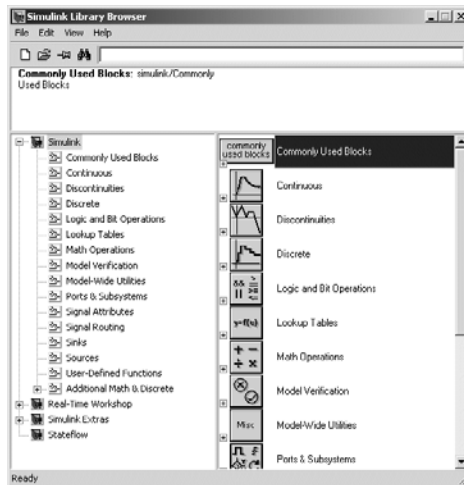

The Library Browser displays a tree-structured view of the Simulink block libraries installed on your system. You can build models by copying blocks from the Library Browser into a model window (see “Editing Blocks” on page 5-4).

On Macintosh or Linux platforms, starting Simulink displays the Simulink block library window.

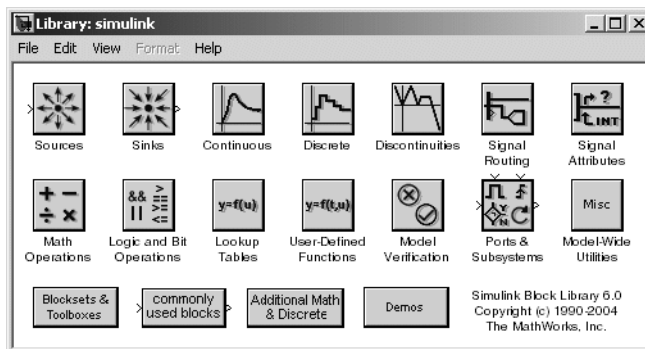

The Simulink library window displays icons representing the block libraries that come with Simulink. You can create models by copying blocks from the library into a model window.

Note On Windows, you can display the Simulink library window by right-clicking the Simulink node in the Library Browser window.

Opening Models

To edit an existing model diagram, either

- Click the **Open** button on the Library Browser's toolbar (Windows only) or select **Open** from the Simulink library window's **File** menu and then choose or enter the file name for the model to edit.
- Enter the name of the model (without the `.mdl` extension) in the MATLAB Command Window. The model must be in the current directory or on the path.

Note If the character encoding of the model to be opened differs from the character encoding of the current MATLAB session, you should change the MATLAB encoding to the model encoding before opening the model, using the `slCharacterEncoding` command.

Avoiding Initial Model Open Delay

You may notice that the first model that you open in a MATLAB session takes longer to open than do subsequent models. This is because to reduce its own startup time and to avoid unnecessary consumption of your system's memory, MATLAB does not load Simulink into memory until the first time you open a Simulink model. You can cause MATLAB to load Simulink at MATLAB startup, and thus avoid the initial model opening delay, using either the `-r` MATLAB command line option or your MATLAB `startup.m` file to run either `load_simulink` (loads Simulink) or `simulink` (loads Simulink and opens the Simulink Library browser) at MATLAB startup. For example, to load Simulink at MATLAB startup on Microsoft Windows systems, create a desktop shortcut with the following target:

```
<matlabroot>\bin\win32\matlab.exe -r load_simulink
```

Similarly, the following command loads Simulink at MATLAB startup on UNIX systems:

```
matlab -r load_simulink
```

Entering Simulink Commands

You run Simulink and work with your model by entering commands. You can enter commands by

- Selecting items from the Simulink menu bar
- Selecting items from a context-sensitive Simulink menu (Windows only)
- Clicking buttons on the Simulink toolbar (Windows only)
- Entering commands in the MATLAB Command Window

Using the Simulink Menu Bar to Enter Commands

The Simulink menu bar appears near the top of each model window. The menu commands apply to the contents of that window.

Using Context-Sensitive Menus to Enter Commands

Simulink displays a context-sensitive menu when you click the right mouse button over a model or block library window. The contents of the menu depend on whether a block is selected. If a block is selected, the menu displays commands that apply only to the selected block. If no block is selected, the menu displays commands that apply to a model or library as a whole.

Using the Simulink Toolbar to Enter Commands

Model windows in the Windows version of Simulink optionally display a toolbar beneath the Simulink menu bar. To display the toolbar, select the **Toolbar** option on the Simulink **View** menu.

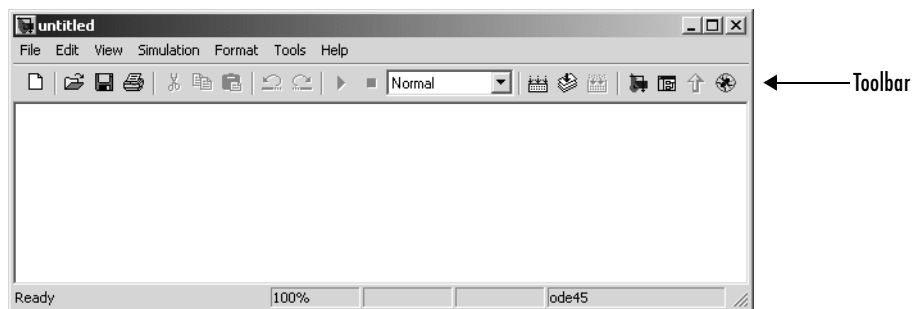

The toolbar contains buttons corresponding to frequently used Simulink commands, such as those for opening, running, and closing models. You can run such commands by clicking the corresponding button. For example, to open a Simulink model, click the button containing the open folder icon. You can determine which command a button executes by moving the mouse pointer over the button. A small window appears containing text that describes the button. The window is called a tooltip. Each button on the toolbar displays a tooltip when the mouse pointer hovers over it. You can hide the toolbar by clearing the **Toolbar** option on the **Simulink View** menu.

Using the MATLAB Window to Enter Commands

When you run a simulation and analyze its results, you can enter MATLAB commands in the MATLAB Command Window. See Chapter 10, “Running Simulations,” and Chapter 11, “Analyzing Simulation Results,” for more information.

Undoing a Command

You can cancel the effects of up to 101 consecutive operations by choosing **Undo** from the **Edit** menu. You can undo these operations:

- Adding, deleting, or moving a block
- Adding, deleting, or moving a line
- Adding, deleting, or moving a model annotation
- Editing a block name
- Creating a subsystem (see “Undoing Subsystem Creation” on page 4-22 for more information)

You can reverse the effects of an **Undo** command by choosing **Redo** from the **Edit** menu.

Simulink Windows

Simulink uses separate windows to display a block library browser, a block library, a model, and graphical (scope) simulation output. These windows are not MATLAB figure windows and cannot be manipulated using Handle Graphics® commands.

Simulink windows are sized to accommodate the most common screen resolutions available. If you have a monitor with exceptionally high or low resolution, you might find the window sizes too small or too large. If this is the case, resize the window and save the model to preserve the new window dimensions.

Status Bar

The Windows version of Simulink displays a status bar at the bottom of each model and library window.

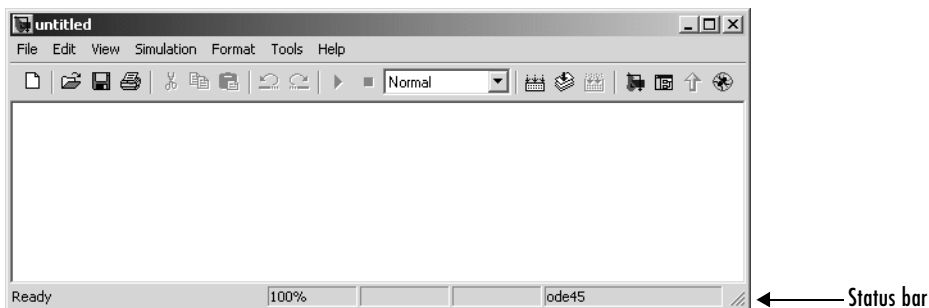

When a simulation is running, the status bar displays the status of the simulation, including the current simulation time and the name of the current solver. You can display or hide the status bar by selecting or clearing the **Status Bar** option on the Simulink **View** menu.

Zooming Block Diagrams

Simulink allows you to enlarge or shrink the view of the block diagram in the current Simulink window. To zoom a view:

- Select **Zoom In** from the **View** menu (or type r) to enlarge the view.
- Select **Zoom Out** from the **View** menu (or type v) to shrink the view.

- Select **Fit System to View** from the **View** menu (or press the space bar) to fit the diagram to the view.
- Select **Normal** from the **View** menu to view the diagram at actual size.

By default, Simulink fits a block diagram to view when you open the diagram either in the model browser's content pane or in a separate window. If you change a diagram's zoom setting, Simulink saves the setting when you close the diagram and restores the setting the next time you open the diagram. If you want to restore the default behavior, choose **Fit System to View** from the **View** menu the next time you open the diagram.

Panning Block Diagrams

You can use the mouse to pan model diagrams that are too large to fit in the model editor's window. To do this, position the mouse over the diagram and hold down the left mouse button and the P or Q key on the keyboard. Moving the mouse now pans the model diagram in the editor window.

Saving a Model

You can save a model by choosing either the **Save** or **Save As** command from the **File** menu. Simulink saves the model by generating a specially formatted file called the *model file* (with the `.mdl` extension) that contains the block diagram and block properties.

If you are saving a model for the first time, use the **Save** command to provide a name and location for the model file. Model file names must start with a letter and can contain no more than 63 letters, numbers, and underscores. The file name must not be the same as that of a MATLAB command.

If you are saving a model whose model file was previously saved, use the **Save** command to replace the file's contents or the **Save As** command to save the model with a new name or location. You can also use the **Save As** command to save the model in a format compatible with previous releases of Simulink (see "Saving a Model in Earlier Formats" on page 3-9).

Simulink follows this procedure while saving a model:

- 1 If the `mdl` file for the model already exists, it is renamed as a temporary file.
- 2 Simulink executes all block `PreSaveFcn` callback routines, then executes the block diagram's `PreSaveFcn` callback routine.
- 3 Simulink writes the model file to a new file using the same name and an extension of `mdl`.
- 4 Simulink executes all block `PostSaveFcn` callback routines, then executes the block diagram's `PostSaveFcn` callback routine.
- 5 Simulink deletes the temporary file.

If an error occurs during this process, Simulink renames the temporary file to the name of the original model file, writes the current version of the model to a file with an `.err` extension, and issues an error message. Simulink performs steps 2 through 4 even if an error occurs in an earlier step.

Saving a Model in Earlier Formats

The **Save As** command allows you to save a model created with the latest version of Simulink in formats used by earlier versions of Simulink, including

Simulink 3 (Release 11), Simulink 4 (Release 12), and Simulink 4.1 (Release 12.1). You might want to do this, for example, if you need to make a model available to colleagues who have access only to one of these earlier versions of Simulink.

To save a model in earlier format:

- 1 Select **Save As** from the Simulink **File** menu.

Simulink displays the **Save As** dialog box.

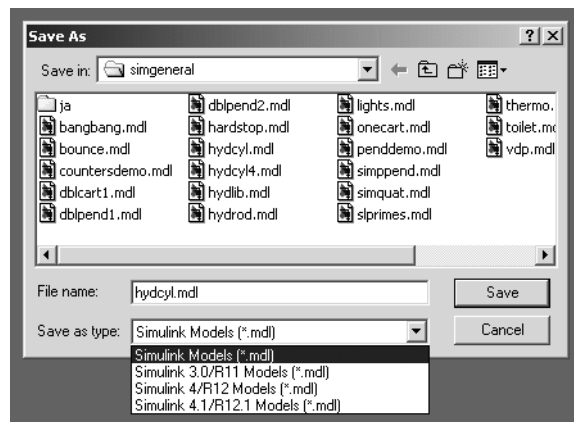

- 2 Select a format from the **Save as type** list on the dialog box.
- 3 Click the **Save** button.

When saving a model in an earlier version’s format, Simulink saves the model in that format regardless of whether the model contains blocks and features that were introduced after that version. If the model does contain blocks or use features that postdate the earlier version, the model might not give correct results when run by the earlier version. For example, matrix and frame signals do not work in Release 11, because Release 11 does not have matrix and frame support. Similarly, models that contain unconditionally executed subsystems marked “Treat as atomic unit” might produce different results in Release 11, because Release 11 does not support unconditionally executed atomic subsystems.

The command converts blocks that postdate the earlier version into empty masked subsystem blocks colored yellow. For example, post-Release 11 blocks include

- Lookup Table (n-D)
- Assertion
- Rate Transition
- PreLookup Index Search
- Interpolation (n-D)
- Direct Lookup Table (n-D)
- Polynomial
- Matrix Concatenation
- Signal Specification
- Bus Creator
- If, WhileIterator, ForIterator, Assignment
- SwitchCase
- Bitwise Logical Operator

Post-Release 11 blocks from Simulink blocksets appear as unlinked blocks.

Printing a Block Diagram

You can print a block diagram by selecting **Print** from the **File** menu (on a Microsoft Windows system) or by using the print command in the MATLAB Command Window (on all platforms).

On a Microsoft Windows system, the **Print** menu item prints the block diagram in the current window.

Print Dialog Box

When you select the **Print** menu item, the **Print** dialog box appears. The **Print** dialog box enables you to selectively print systems within your model. Using the dialog box, you can print

- The current system only
- The current system and all systems above it in the model hierarchy
- The current system and all systems below it in the model hierarchy, with the option of looking into the contents of masked and library blocks
- All systems in the model, with the option of looking into the contents of masked and library blocks
- An overlay frame on each diagram

The portion of the **Print** dialog box that supports selective printing is similar on supported platforms. This figure shows how it looks on a Microsoft Windows system. In this figure, only the current system is to be printed.

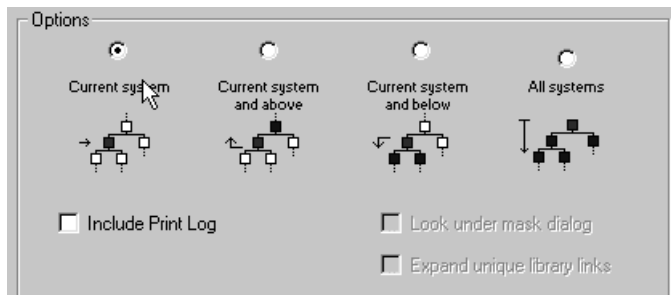

When you select either the **Current system and below** or **All systems** option, two check boxes become enabled. In this figure, **All systems** is selected.

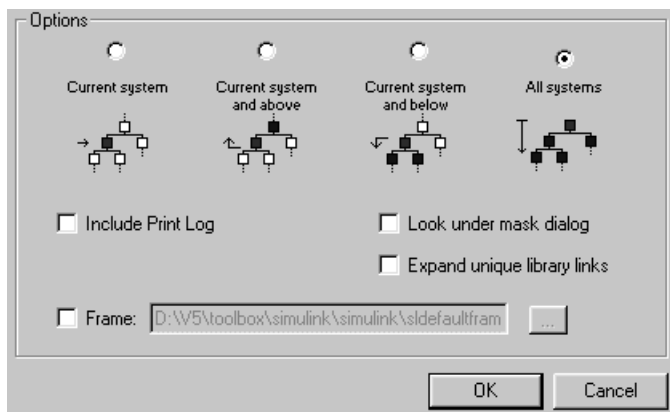

Selecting the **Look Under Mask Dialog** check box prints the contents of masked subsystems when encountered at or below the level of the current block. When you are printing all systems, the top-level system is considered the current block, so Simulink looks under any masked blocks encountered.

Selecting the **Expand Unique Library Links** check box prints the contents of library blocks when those blocks are systems. Only one copy is printed regardless of how many copies of the block are contained in the model. For more information about libraries, see “Working with Block Libraries” on page 5-29.

The print log lists the blocks and systems printed. To print the print log, select the **Include Print Log** check box.

Selecting the **Frame** check box prints a title block frame on each diagram. Enter the path to the title block frame in the adjacent edit box. You can create a customized title block frame, using the MATLAB frame editor. See `frameedit` in the online MATLAB reference for information on using the frame editor to create title block frames.

Print Command

The format of the print command is

```
print -ssys -device filename
```

`sys` is the name of the system to be printed. The system name must be preceded by the `s` switch identifier and is the only required argument. `sys` must be open or must have been open during the current session. If the system name contains spaces or takes more than one line, you need to specify the name as a string. See the examples below.

`device` specifies a device type. For a list and description of device types, see the documentation for the MATLAB `print` function.

`filename` is the PostScript file to which the output is saved. If `filename` exists, it is replaced. If `filename` does not include an extension, an appropriate one is appended.

For example, this command prints a system named `untitled`.

```
print -suntitled
```

This command prints the contents of a subsystem named `Sub1` in the current system.

```
print -sSub1
```

This command prints the contents of a subsystem named `Requisite Friction`.

```
print (['-sRequisite Friction'])
```

The next example prints a system named `Friction Model`, a subsystem whose name appears on two lines. The first command assigns the newline character to a variable; the second prints the system.

```
cr = sprintf('\n');  
print (['-sFriction' cr 'Model'])
```

To print the currently selected subsystem, enter

```
print(['-s', gcb])
```

Specifying Paper Size and Orientation

Simulink lets you specify the type and orientation of the paper used to print a model diagram. You can do this on all platforms by setting the model's `PaperType` and `PaperOrientation` properties, respectively (see “Model and Block Parameters” in the online documentation), using the `set_param` command. You can set the paper orientation alone, using the MATLAB `orient`

command. On Windows, the **Print** and **Printer Setup** dialog boxes let you set the page type and orientation properties as well.

Positioning and Sizing a Diagram

You can use a model's `PaperPositionMode` and `PaperPosition` parameters to position and size the model's diagram on the printed page. The value of the `PaperPosition` parameter is a vector of form [left bottom width height]. The first two elements specify the bottom left corner of a rectangular area on the page, measured from the page's bottom left corner. The last two elements specify the width and height of the rectangle. When the model's `PaperPositionMode` is manual, Simulink positions (and scales, if necessary) the model's diagram to fit inside the specified print rectangle. For example, the following commands

```
vdp
set_param('vdp', 'PaperType', 'usletter')
set_param('vdp', 'PaperOrientation', 'landscape')
set_param('vdp', 'PaperPositionMode', 'manual')
set_param('vdp', 'PaperPosition', [0.5 0.5 4 4])
print -svdp
```

print the block diagram of the `vdp` sample model in the lower left corner of a U.S. letter-size page in landscape orientation.

If `PaperPositionMode` is auto, Simulink centers the model diagram on the printed page, scaling the diagram, if necessary, to fit the page.

Generating a Model Report

A Simulink model report is an HTML document that describes a model's structure and content. The report includes block diagrams of the model and its subsystems and the settings of its block parameters.

To generate a report for the current model:

- 1 Select **Print details** from the model's **File** menu.

The **Print Details** dialog box appears.

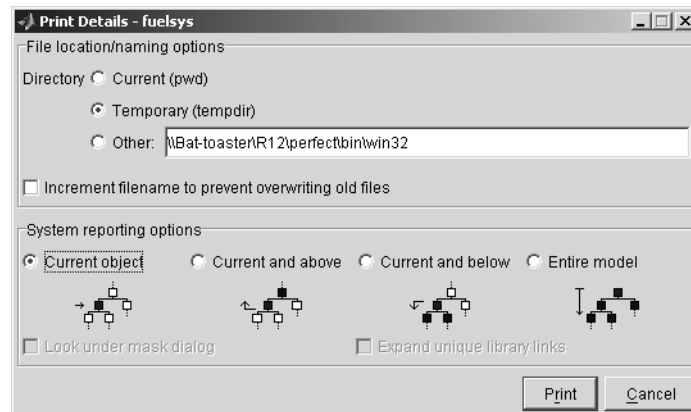

The dialog box allows you to select various report options (see “Model Report Options” on page 3-17).

- 2 Select the desired report options on the dialog box.
- 3 Select **Print**.

Simulink generates the HTML report and displays the in your system's default HTML browser.

While generating the report, Simulink displays status messages on a messages pane that replaces the options pane on the **Print Details** dialog box.

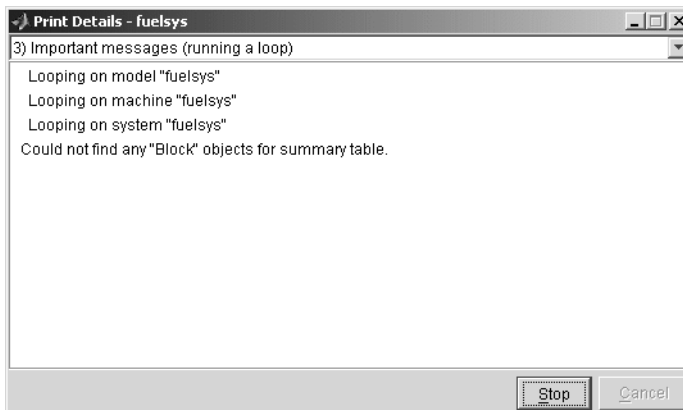

You can select the detail level of the messages from the list at the top of the messages pane. When the report generation process begins, the **Print** button on the **Print Details** dialog box changes to a **Stop** button. Clicking this button terminates the report generation. When the report generation process finishes, the **Stop** button changes to an **Options** button. Clicking this button redisplay the report generation options, allowing you to generate another report without having to reopen the **Print Details** dialog box.

Model Report Options

The **Print Details** dialog box allows you to select the following report options.

Directory

The directory where Simulink stores the HTML report that it generates. The options include your system's temporary directory (the default), your system's current directory, or another directory whose path you specify in the adjacent edit field.

Increment filename to prevent overwriting old files

Creates a unique report file name each time you generate a report for the same model in the current session. This preserves each report.

Current object

Include only the currently selected object in the report.

Current and above

Include the current object and all levels of the model above the current object in the report.

Current and below

Include the current object and all levels below the current object in the report.

Entire model

Include the entire model in the report.

Look under mask dialog

Include the contents of masked subsystems in the report.

Expand unique library links

Include the contents of library blocks that are subsystems. The report includes a library subsystem only once even if it occurs in more than one place in the model.

Summary of Mouse and Keyboard Actions

These tables summarize the use of the mouse and keyboard to manipulate blocks, lines, and signal labels. LMB means press the left mouse button; CMB, the center mouse button; and RMB, the right mouse button.

Manipulating Blocks

The following table lists mouse and keyboard actions that apply to blocks.

Task	Microsoft Windows	Macintosh or Linux
Select one block	LMB	LMB
Select multiple blocks	Shift + LMB	Shift + LMB; or CMB alone
Copy block from another window	Drag block	Drag block
Move block	Drag block	Drag block
Duplicate block	Ctrl + LMB and drag; or RMB and drag	Ctrl + LMB and drag; or RMB and drag
Connect blocks	LMB	LMB
Disconnect block	Shift + drag block	Shift + drag block; or CMB and drag
Open selected subsystem	Enter	Return
Go to parent of selected subsystem	Esc	Esc

Manipulating Lines

The following table lists mouse and keyboard actions that apply to lines.

Task	Microsoft Windows	Macintosh or Linux
Select one line	LMB	LMB
Select multiple lines	Shift + LMB	Shift + LMB; or CMB alone
Draw branch line	Ctrl + drag line; or RMB and drag line	Ctrl + drag line; or RMB + drag line
Route lines around blocks	Shift + draw line segments	Shift + draw line segments; or CMB and draw segments
Move line segment	Drag segment	Drag segment
Move vertex	Drag vertex	Drag vertex
Create line segments	Shift + drag line	Shift + drag line; or CMB + drag line

Manipulating Signal Labels

The next table lists mouse and keyboard actions that apply to signal labels.

Action	Microsoft Windows	Macintosh or Linux
Create signal label	Double-click line, then enter label	Double-click line, then enter label
Copy signal label	Ctrl + drag label	Ctrl + drag label
Move signal label	Drag label	Drag label
Edit signal label	Click in label, then edit	Click in label, then edit
Delete signal label	Shift + click label, then press Delete	Shift + click label, then press Delete

Manipulating Annotations

The next table lists mouse and keyboard actions that apply to annotations.

Action	Microsoft Windows	Macintosh or Linux
Create annotation	Double-click in diagram, then enter text	Double-click in diagram, then enter text
Copy annotation	Ctrl + drag label	Ctrl + drag label
Move annotation	Drag label	Drag label
Edit annotation	Click in text, then edit	Click in text, then edit
Delete annotation	Shift + select annotation, then press Delete	Shift + select annotation, then press Delete

Ending a Simulink Session

Terminate a Simulink session by closing all Simulink windows.

Terminate a MATLAB session by choosing one of these commands from the **File** menu:

- On a Microsoft Windows system: **Exit MATLAB**
- On a Macintosh or Linux system: **Quit MATLAB**

Creating a Model

The following sections explain how to create Simulink models.

Creating a New Model (p. 4-2)	How to create a new model.
Selecting Objects (p. 4-3)	How to select objects in a model.
Specifying Block Diagram Colors (p. 4-5)	How to specify the colors of blocks, lines, and annotations and the background of the diagram.
Connecting Blocks (p. 4-9)	How to draw connections between blocks.
Annotating Diagrams (p. 4-16)	How to add annotations to a block diagram.
Creating Subsystems (p. 4-20)	How to create subsystems.
Creating Conditionally Executed Subsystems (p. 4-26)	How to create subsystems that are executed only when specified events occur or conditions are satisfied.
Modeling with Control Flow Blocks (p. 4-42)	How to use control flow blocks to model control logic.
Referencing Models (p. 4-53)	How to include one model as a block in another model.
Model Discretizer (p. 4-68)	How to create a discrete model from a continuous model.
Using Callback Routines (p. 4-90)	How to use callback routines to customize a model.
Working with Model Workspaces (p. 4-96)	How to modify, save, and reload a model's private workspace.
Managing Model Versions (p. 4-103)	How to use version control systems to manage and track development of Simulink models.

Creating a New Model

To create a new model, click the **New** button on the Library Browser's toolbar (Windows only) or choose **New** from the library window's **File** menu and select **Model**. You can move the window as you do other windows. Chapter 1, "Getting Started" describes how to build a simple model. "Modeling Equations" on page 8-2 describes how to build systems that model equations.

Selecting Objects

Many model building actions, such as copying a block or deleting a line, require that you first select one or more blocks and lines (objects).

Selecting One Object

To select an object, click it. Small black square “handles” appear at the corners of a selected block and near the end points of a selected line. For example, the figure below shows a selected Sine Wave block and a selected line.

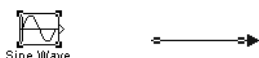

When you select an object by clicking it, any other selected objects are deselected.

Selecting More Than One Object

You can select more than one object either by selecting objects one at a time, by selecting objects located near each other using a bounding box, or by selecting the entire model.

Selecting Multiple Objects One at a Time

To select more than one object by selecting each object individually, hold down the **Shift** key and click each object to be selected. To deselect a selected object, click the object again while holding down the **Shift** key.

Selecting Multiple Objects Using a Bounding Box

An easy way to select more than one object in the same area of the window is to draw a bounding box around the objects:

- 1 Define the starting corner of a bounding box by positioning the pointer at one corner of the box, then pressing and holding down the mouse button. Notice the shape of the cursor.

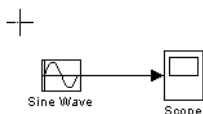

- 2 Drag the pointer to the opposite corner of the box. A dotted rectangle encloses the selected blocks and lines.

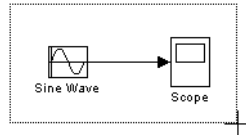

- 3 Release the mouse button. All blocks and lines at least partially enclosed by the bounding box are selected.

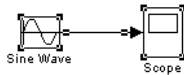

Selecting the Entire Model

To select all objects in the active window, choose **Select All** from the **Edit** menu. You cannot create a subsystem by selecting blocks and lines in this way. For more information, see “Creating Subsystems” on page 4-20.

Specifying Block Diagram Colors

Simulink allows you to specify the foreground and background colors of any block or annotation in a diagram, as well as the diagram's background color. To set the background color of a block diagram, select **Screen color** from the Simulink **Format** menu. To set the background color of a block or annotation or group of such items, first select the item or items. Then select **Background color** from the Simulink **Format** menu. To set the foreground color of a block or annotation, first select the item. Then select **Foreground color** from the Simulink **Format** menu.

In all cases, Simulink displays a menu of color choices. Choose the desired color from the menu. If you select a color other than **Custom**, Simulink changes the background or foreground color of the diagram or diagram element to the selected color.

Choosing a Custom Color

If you choose **Custom**, Simulink displays the Simulink **Choose Custom Color** dialog box.

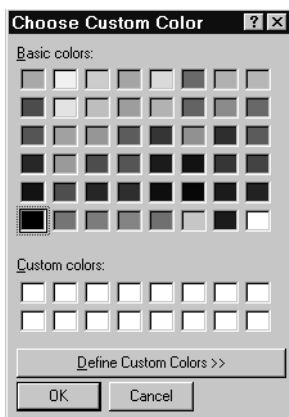

The dialog box displays a palette of basic colors and a palette of custom colors that you previously defined. If you have not previously created any custom colors, the custom color palette is all white. To choose a color from either palette, click the color, and then click the **OK** button.

Defining a Custom Color

To define a custom color, click the **Define Custom Colors** button on the **Choose Custom Color** dialog box. The dialog box expands to display a custom color definer.

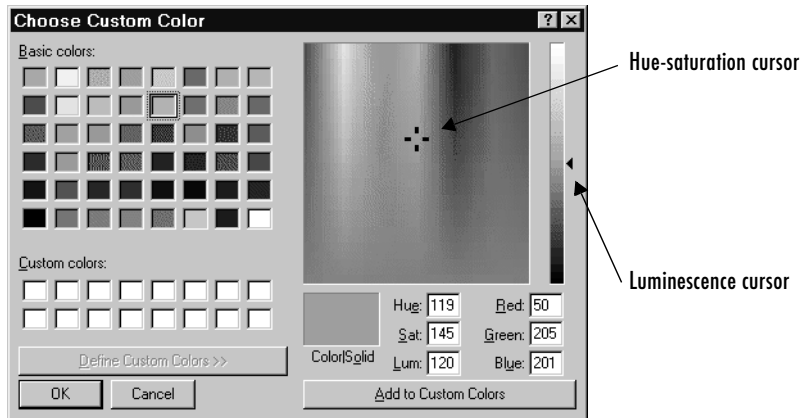

The color definer allows you to specify a custom color by

- Entering the red, green, and blue components of the color as values between 0 (darkest) and 255 (brightest)
- Entering hue, saturation, and luminescence components of the color as values in the range 0 to 255
- Moving the hue-saturation cursor to select the hue and saturation of the desired color and the luminescence cursor to select the luminescence of the desired color

The color that you have defined in any of these ways appears in the **Color|Solid** box. To redefine a color in the **Custom colors** palette, select the color and define a new color, using the color definer. Then click the **Add to Custom Colors** button on the color definer.

Specifying Colors Programmatically

You can use the `set_param` command at the MATLAB command line or in an M-file program to set parameters that determine the background color of a diagram and the background color and foreground color of diagram elements.

The following table summarizes the parameters that control block diagram colors.

Parameter	Determines
ScreenColor	Background color of block diagram
BackgroundColor	Background color of blocks and annotations
ForegroundColor	Foreground color of blocks and annotations

You can set these parameters to any of the following values:

- 'black', 'white', 'red', 'green', 'blue', 'cyan', 'magenta', 'yellow', 'gray', 'lightBlue', 'orange', 'darkGreen'
- '[r,g,b]'
where r, g, and b are the red, green, and blue components of the color normalized to the range 0.0 to 1.0.

For example, the following command sets the background color of the currently selected system or subsystem to a light green color:

```
set_param(gcs, 'ScreenColor', '[0.3, 0.9, 0.5]')
```

Displaying Sample Time Colors

Simulink can color code the blocks and lines in your model to indicate the sample rates at which the blocks operate.

Color	Use
Black	Continuous blocks
Magenta	Constant blocks
Yellow	Hybrid (subsystems grouping blocks, or Mux or Demux blocks grouping signals with varying sample times)
Red	Fastest discrete sample time
Green	Second fastest discrete sample time

Color	Use
Blue	Third fastest discrete sample time
Light Blue	Fourth fastest discrete sample time
Dark Green	Fifth fastest discrete sample time
Orange	Sixth fastest discrete sample time
Cyan	Blocks in triggered subsystems
Gray	Fixed in minor step

To enable the sample time colors feature, select **Sample Time Colors** from the **Format** menu.

Simulink does not automatically recolor the model with each change you make to it, so you must select **Update Diagram** from the **Edit** menu to explicitly update the model coloration. To return to your original coloring, disable sample time coloration by again choosing **Sample Time Colors**.

The color that Simulink assigns to each block depends on its sample time relative to other sample times in the model. This means that the same sample time may be assigned different colors in a toplevel model and in the models that it references (see “Referencing Models” on page 4-53). For example, suppose that a model defines three sample times: 1, 2, and 3. Further, suppose that it references a model that defines two sample times: 2 and 3. In this case, blocks operating at the 2 sample rate appear as green in the toplevel model and as red in the referenced model.

It is important to note that Mux and Demux blocks are simply grouping operators; signals passing through them retain their timing information. For this reason, the lines emanating from a Demux block can have different colors if they are driven by sources having different sample times. In this case, the Mux and Demux blocks are color coded as hybrids (yellow) to indicate that they handle signals with multiple rates.

Similarly, Subsystem blocks that contain blocks with differing sample times are also colored as hybrids, because there is no single rate associated with them. If all the blocks within a subsystem run at a single rate, the Subsystem block is colored according to that rate.

Connecting Blocks

Simulink block diagrams use lines to represent pathways for signals among blocks in a model (see “Annotating Diagrams” on page 4-16 for information on signals). Simulink can connect blocks for you or you can connect the blocks yourself by drawing lines from their output ports to their input ports.

Automatically Connecting Blocks

You can command Simulink to connect blocks automatically. This eliminates the need for you to draw the connecting lines yourself. When connecting blocks, Simulink routes lines around intervening blocks to avoid cluttering the diagram.

Connecting Two Blocks

To autoconnect two blocks:

- 1 Select the source block.

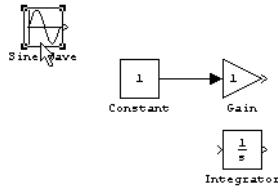

- 2 Hold down **Ctrl** and left-click the destination block.

Simulink connects the source block to the destination block, routing the line around intervening blocks if necessary.

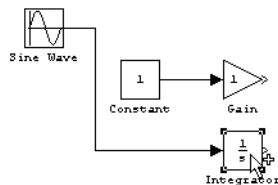

When connecting two blocks, Simulink draws as many connections as possible between the two blocks as illustrated in the following example.

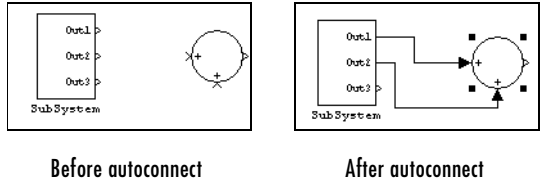

Connecting Groups of Blocks

Simulink can connect a group of source blocks to a destination block or a source block to a group of destination blocks.

To connect a group of source blocks to a destination block:

- 1 Select the source blocks.

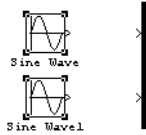

- 2 Hold down **Ctrl** and left-click the destination block.

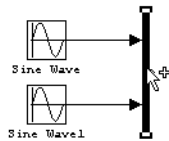

To connect a source block to a group of destination blocks:

- 1 Select the *destination* blocks.

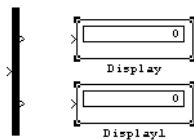

- 2 Hold down **Ctrl** and left-click the *source* block.

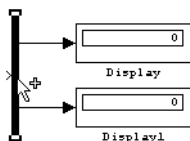

Manually Connecting Blocks

Simulink allows you to draw lines manually between blocks or between lines and blocks. You might want to do this if you need to control the path of the line or to create a branch line.

Drawing a Line Between Blocks

To connect the output port of one block to the input port of another block:

- 1 Position the cursor over the first block's output port. It is not necessary to position the cursor precisely on the port. The cursor shape changes to crosshairs.



- 2 Press and hold down the mouse button.
- 3 Drag the pointer to the second block's input port. You can position the cursor on or near the port or in the block. If you position the cursor in the block, the line is connected to the closest input port. The cursor shape changes to double crosshairs.

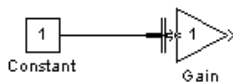

- 4 Release the mouse button. Simulink replaces the port symbols by a connecting line with an arrow showing the direction of the signal flow. You can create lines either from output to input, or from input to output. The arrow is drawn at the appropriate input port, and the signal is the same.

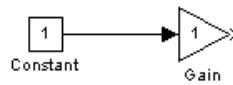

Simulink draws connecting lines using horizontal and vertical line segments. To draw a diagonal line, hold down the **Shift** key while drawing the line.

Drawing a Branch Line

A *branch line* is a line that starts from an existing line and carries its signal to the input port of a block. Both the existing line and the branch line carry the same signal. Using branch lines enables you to cause one signal to be carried to more than one block.

In this example, the output of the Product block goes to both the Scope block and the To Workspace block.

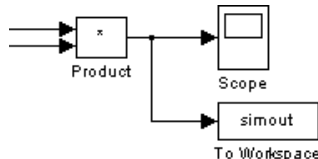

To add a branch line, follow these steps:

- 1 Position the pointer on the line where you want the branch line to start.
- 2 While holding down the **Ctrl** key, press and hold down the left mouse button.
- 3 Drag the pointer to the input port of the target block, then release the mouse button and the **Ctrl** key.

You can also use the right mouse button instead of holding down the left mouse button and the **Ctrl** key.

Drawing a Line Segment

You might want to draw a line with segments exactly where you want them instead of where Simulink draws them. Or you might want to draw a line before you copy the block to which the line is connected. You can do either by drawing line segments.

To draw a line segment, you draw a line that ends in an unoccupied area of the diagram. An arrow appears on the unconnected end of the line. To add another line segment, position the cursor over the end of the segment and draw another segment. Simulink draws the segments as horizontal and vertical lines. To draw diagonal line segments, hold down the **Shift** key while you draw the lines.

Moving a Line Segment

To move a line segment, follow these steps:

- 1 Position the pointer on the segment you want to move.

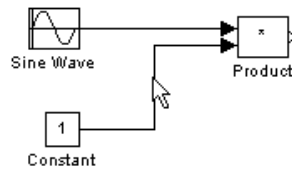

- 2 Press and hold down the left mouse button.

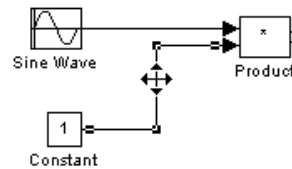

- 3 Drag the pointer to the desired location.

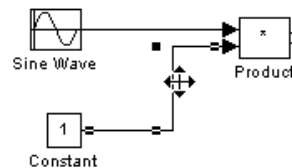

- 4 Release the mouse button.

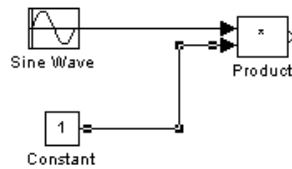

To move the segment connected to an input port, position the pointer over the port and drag the end of the segment to the new location. You cannot move the segment connected to an output port.

Moving a Line Vertex

To move a vertex of a line, follow these steps:

- 1 Position the pointer on the vertex, then press and hold down the mouse button. The cursor changes to a circle that encloses the vertex.

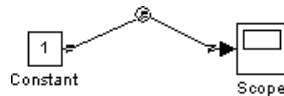

- 2 Drag the pointer to the desired location.

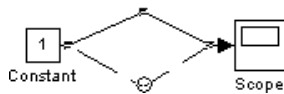

- 3 Release the mouse button.



Inserting Blocks in a Line

You can insert a block in a line by dropping the block on the line. Simulink inserts the block for you at the point where you drop the block. The block that you insert can have only one input and one output.

To insert a block in a line:

- 1 Position the pointer over the block and press the left mouse button.

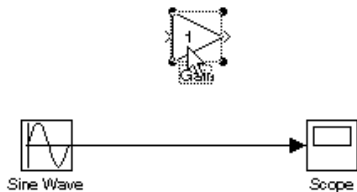

- 2 Drag the block over the line in which you want to insert the block.

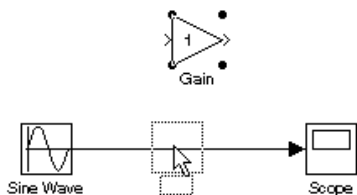

- 3 Release the mouse button to drop the block on the line. Simulink inserts the block where you dropped it.

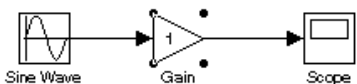

Disconnecting Blocks

To disconnect a block from its connecting lines, hold down the **Shift** key, then drag the block to a new location.

Annotating Diagrams

Annotations provide textual information about a model. You can add an annotation to any unoccupied area of your block diagram.

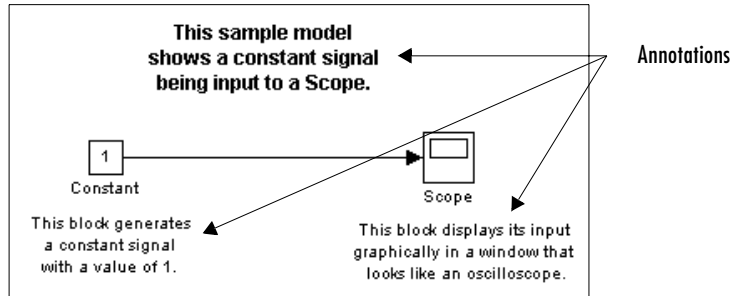

To create a model annotation, double-click an unoccupied area of the block diagram. A small rectangle appears and the cursor changes to an insertion point. Start typing the annotation contents. Each line is centered within the rectangle that surrounds the annotation.

To move an annotation, drag it to a new location.

To edit an annotation, select it:

- To replace the annotation, click the annotation, then double-click or drag the cursor to select it. Then, enter the new annotation.
- To insert characters, click between two characters to position the insertion point, then insert text.
- To replace characters, drag the mouse to select a range of text to replace, then enter the new text.

To delete an annotation, hold down the **Shift** key while you select the annotation, then press the **Delete** or **Backspace** key.

To change the font of all or part of an annotation, select the text in the annotation you want to change, then choose **Font** from the **Format** menu. Select a font and size from the dialog box.

To change the text alignment (e.g., left, center, or right) of the annotation, select the annotation and choose **Text Alignment** from the model window's

Format or context menu. Then choose one of the alignment options (e.g., **Center**) from the **Text Alignment** submenu.

Using TeX Formatting Commands in Annotations

You can use TeX formatting commands to include mathematical and other symbols and Greek letters in block diagram annotations.

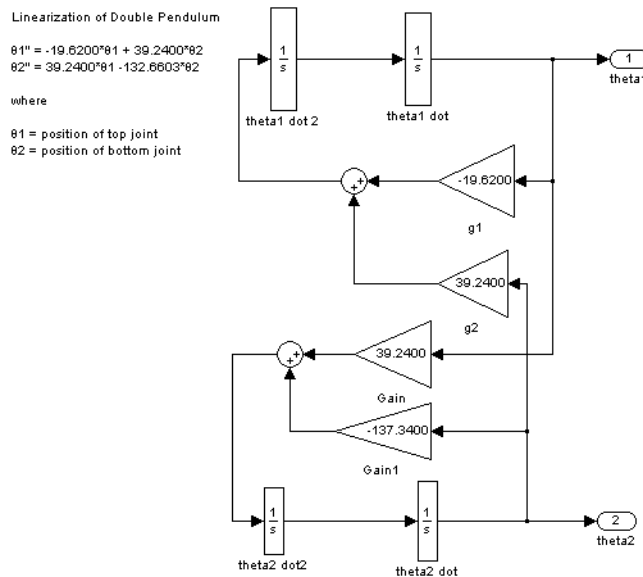

To use TeX commands in an annotation:

- 1 Select the annotation.
- 2 Select **Enable TeX Commands** from the **Edit** menu on the model window.

- 3 Enter or edit the text of the annotation, using TeX commands where needed to achieve the desired appearance.

```
Linearization of Double Pendulum
\theta1'' = -19.6200*\theta1 + 39.2400*\theta2
\theta2'' = 39.2400*\theta1 - 132.6603*\theta2
where
\theta1 = position of top joint
\theta2 = position of bottom joint
```

See “Mathematical Symbols, Greek Letters, and TeX Characters” in the MATLAB documentation for information on the TeX formatting commands supported by Simulink.

- 4 Deselect the annotation by clicking outside it or typing **Esc**.

Simulink displays the formatted text.

```
Linearization of Double Pendulum
θ1'' = -19.6200*θ1 + 39.2400*θ2
θ2'' = 39.2400*θ1 - 132.6603*θ2
where
θ1 = position of top joint
θ2 = position of bottom joint
```

Creating Annotations Programmatically

You can use the Simulink `add_block` command to create annotations at the command line or in an M-file program. Use the following syntax to create the annotation:

```
add_block('built-in/Note','path/text','Position',[center_x, 0, 0, center_y]);
```

where `path` is the path of the diagram to be annotated, `text` is the text of the annotation, and `[center_x, 0, 0, center_y]` is the position of the center of the annotation in pixels relative to the upper left corner of the diagram. For example, the following sequence of commands

```
new_system('test')
open_system('test')
```



```
add_block('built-in/Gain', 'test/Gain', 'Position', [260, 125,  
290, 155])  
add_block('built-in/Note', 'test/programmatically created',  
'Position', [550 0 0 180])
```

creates the following model:

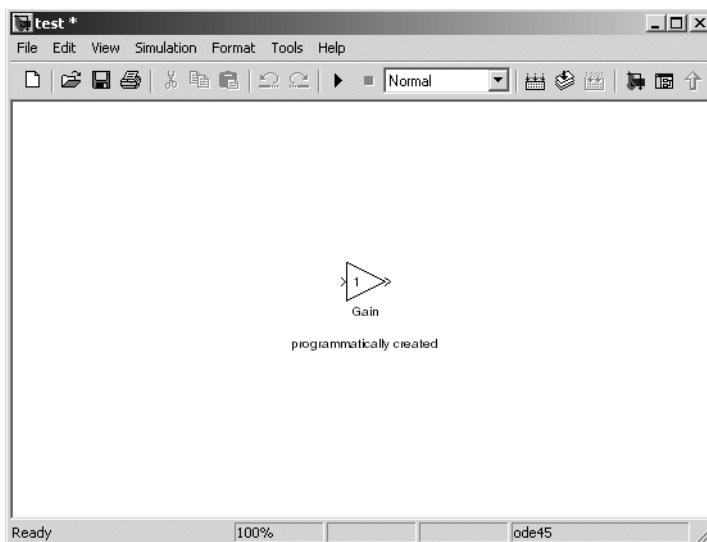

Creating Subsystems

As your model increases in size and complexity, you can simplify it by grouping blocks into subsystems. Using subsystems has these advantages:

- It helps reduce the number of blocks displayed in your model window.
- It allows you to keep functionally related blocks together.
- It enables you to establish a hierarchical block diagram, where a Subsystem block is on one layer and the blocks that make up the subsystem are on another.

You can create a subsystem in two ways:

- Add a Subsystem block to your model, then open that block and add the blocks it contains to the subsystem window.
- Add the blocks that make up the subsystem, then group those blocks into a subsystem.

Creating a Subsystem by Adding the Subsystem Block

To create a subsystem before adding the blocks it contains, add a Subsystem block to the model, then add the blocks that make up the subsystem:

- 1 Copy the Subsystem block from the Signals & Systems library into your model.
- 2 Open the Subsystem block by double-clicking it.

Simulink opens the subsystem in the current or a new model window, depending on the model window reuse mode that you selected (see “Window Reuse” on page 4-23).

- 3 In the empty Subsystem window, create the subsystem. Use Inport blocks to represent input from outside the subsystem and Outport blocks to represent external output.

For example, the subsystem shown includes a Sum block and Inport and Outport blocks to represent input to and output from the subsystem.

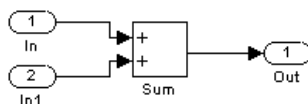

Creating a Subsystem by Grouping Existing Blocks

If your model already contains the blocks you want to convert to a subsystem, you can create the subsystem by grouping those blocks:

- 1 Enclose the blocks and connecting lines that you want to include in the subsystem within a bounding box. You cannot specify the blocks to be grouped by selecting them individually or by using the **Select All** command. For more information, see “Selecting Multiple Objects Using a Bounding Box” on page 4-3.

For example, this figure shows a model that represents a counter. The Sum and Unit Delay blocks are selected within a bounding box.

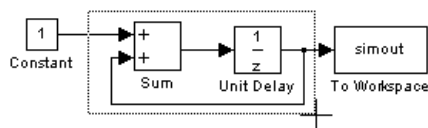

When you release the mouse button, the two blocks and all the connecting lines are selected.

- 2 Choose **Create Subsystem** from the **Edit** menu. Simulink replaces the selected blocks with a Subsystem block.

This figure shows the model after you choose the **Create Subsystem** command (and resize the Subsystem block so the port labels are readable).

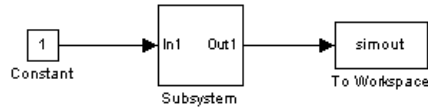

If you open the Subsystem block, Simulink displays the underlying system, as shown below. Notice that Simulink adds Inport and Outport blocks to represent input from and output to blocks outside the subsystem.

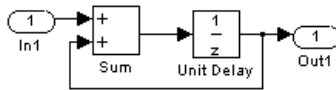

As with all blocks, you can change the name of the Subsystem block. You can also use the masking feature to customize the block's appearance and dialog box. See Chapter 12, “Creating Masked Subsystems.”

Undoing Subsystem Creation

To undo creation of a subsystem by grouping blocks, select **Undo** from the **Edit** menu. You can undo creation of a subsystem that you have subsequently edited. However, the **Undo** command does not undo any nongraphical changes that you made to the blocks, such as changing the value of a block parameter or the name of a block. Simulink alerts you to this limitation by displaying a warning dialog box before undoing creation of a modified subsystem.

Model Navigation Commands

Subsystems allow you to create a hierarchical model comprising many layers. You can navigate this hierarchy, using the Simulink Model Browser (see “The Model Browser” on page 9-22) and/or the following model navigation commands:

- **Open**

The **Open** command opens the currently selected subsystem. To execute the command, choose **Open** from the Simulink **Edit** menu, press **Enter**, or double-click the subsystem.

- **Open block in new window**

Opens the currently selected subsystem regardless of the Simulink window reuse settings (see “Window Reuse” on page 4-23).

- **Go to Parent**

The **Go to Parent** command displays the parent of the subsystem displayed in the current window. To execute the command, press **Esc** or select **Go to Parent** from the Simulink **View** menu.

Window Reuse

You can specify whether Simulink model navigation commands use the current window or a new window to display a subsystem or its parent. Reusing windows avoids cluttering your screen with windows. Creating a window for each subsystem allows you to view subsystems side by side with their parents or siblings. To specify your preference regarding window reuse, select **Preferences** from the Simulink **File** menu and then select one of the following **Window reuse type** options listed in the Simulink **Preferences** dialog box.

Reuse Type	Open Action	Go to Parent (Esc) Action
none	Subsystem appears in a new window.	Parent window moves to the front.
reuse	Subsystem replaces the parent in the current window.	Parent window replaces subsystem in current window

Reuse Type	Open Action	Go to Parent (Esc) Action
replace	Subsystem appears in a new window. Parent window disappears.	Parent window appears. Subsystem window disappears.
mixed	Subsystem appears in its own window.	Parent window rises to front. Subsystem window disappears.

Labeling Subsystem Ports

Simulink labels ports on a Subsystem block. The labels are the names of Inport and Outport blocks that connect the subsystem to blocks outside the subsystem through these ports.

You can hide (or show) the port labels by

- Selecting the Subsystem block, then choosing **Hide Port Labels** (or **Show Port Labels**) from the **Format** menu
- Selecting an Inport or Outport block in the subsystem and choosing **Hide Name** (or **Show Name**) from the **Format** menu
- Selecting the **Show port labels** option in the Subsystem block's parameter dialog

This figure shows two models. The subsystem on the left contains two Inport blocks and one Outport block. The Subsystem block on the right shows the labeled ports.

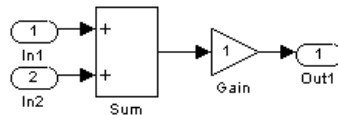

Subsystem with Inport and Outport blocks

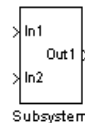

Subsystem with labeled ports

Controlling Access to Subsystems

Simulink allows you to control user access to subsystems that reside in libraries. In particular, you can prevent a user from viewing or modifying the

contents of a library subsystem while still allowing the user to employ the subsystem in a model.

To control access to a library subsystem, open the subsystem's parameter dialog box and set its *Access* parameter to either *ReadOnly* or *NoReadOrWrite*. The first option allows a user to view the contents of the library subsystem and make local copies but prevents the user from modifying the original library copy. The second option prevents the user from viewing the contents of, creating local copies, or modifying the permissions of the library subsystem. See the *Subsystem* block for more information on subsystem access options. Note that both options allow a user to use the library system in models by creating links (see "Working with Block Libraries" on page 5-29).

Creating Conditionally Executed Subsystems

A *conditionally executed subsystem* is a subsystem whose execution depends on the value of an input signal. The signal that controls whether a subsystem executes is called the *control signal*. The signal enters the Subsystem block at the *control input*.

Conditionally executed subsystems can be very useful when you are building complex models that contain components whose execution depends on other components.

Simulink supports the following types of conditionally executed subsystems:

- An *enabled subsystem* executes while the control signal is positive. It starts execution at the time step where the control signal crosses zero (from the negative to the positive direction) and continues execution while the control signal remains positive. Enabled subsystems are described in more detail in “Enabled Subsystems” on page 4-26.
- A *triggered subsystem* executes once each time a trigger event occurs. A trigger event can occur on the rising or falling edge of a trigger signal, which can be continuous or discrete. Triggered subsystems are described in more detail in “Triggered Subsystems” on page 4-31.
- A *triggered and enabled subsystem* executes once on the time step when a trigger event occurs if the enable control signal has a positive value at that step. See “Triggered and Enabled Subsystems” on page 4-35 for more information.
- A *control flow subsystem* executes one or more times at the current time step when enabled by a control flow block that implements control logic similar to that expressed by programming language control flow statements (e.g., if-then, while, do, and for. See “Modeling with Control Flow Blocks” on page 4-42 for more information.

Enabled Subsystems

Enabled subsystems are subsystems that execute at each simulation step where the control signal has a positive value.

An enabled subsystem has a single control input, which can be scalar or vector valued.

- If the input is a scalar, the subsystem executes if the input value is greater than zero.
- If the input is a vector, the subsystem executes if *any* of the vector elements is greater than zero.

For example, if the control input signal is a sine wave, the subsystem is alternately enabled and disabled, as shown in this figure. An up arrow signifies enable, a down arrow disable.

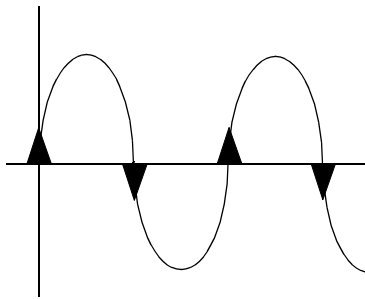

Simulink uses the zero-crossing slope method to determine whether an enable is to occur. If the signal crosses zero and the slope is positive, the subsystem is enabled. If the slope is negative at the zero crossing, the subsystem is disabled.

Creating an Enabled Subsystem

You create an enabled subsystem by copying an Enable block from the Signals & Systems library into a subsystem. Simulink adds an enable symbol and an enable control input port to the Subsystem block.



Setting Output Values While the Subsystem Is Disabled. Although an enabled subsystem does not execute while it is disabled, the output signal is still available to other blocks. While an enabled subsystem is disabled, you can choose to hold the subsystem outputs at their previous values or reset them to their initial conditions.

Open each Outport block's dialog box and select one of the choices for the **Output when disabled** parameter, as shown in the following dialog box:

- Choose held to cause the output to maintain its most recent value.
- Choose reset to cause the output to revert to its initial condition. Set the **Initial output** to the initial value of the output.

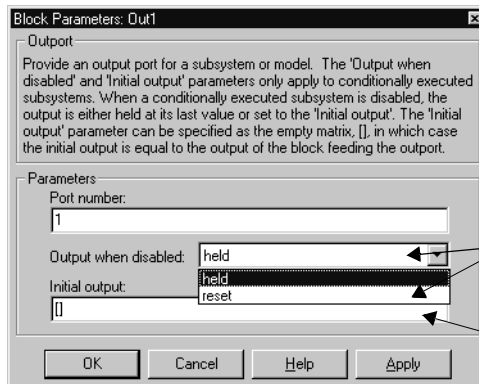

Select an option to set the Outport output while the subsystem is disabled.

The initial condition and the value when reset.

Setting States When the Subsystem Becomes Reenabled. When an enabled subsystem executes, you can choose whether to hold the subsystem states at their previous values or reset them to their initial conditions.

To do this, open the Enable block dialog box and select one of the choices for the **States when enabling** parameter, as shown in the dialog box following:

- Choose held to cause the states to maintain their most recent values.
- Choose reset to cause the states to revert to their initial conditions.

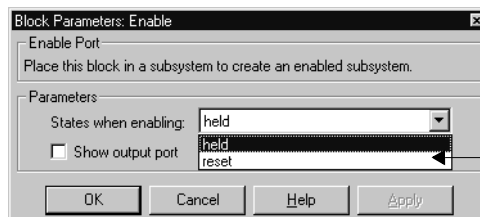

Select an option to set the states when the subsystem is reenabled.

Outputting the Enable Control Signal. An option on the Enable block dialog box lets you output the enable control signal. To output the control signal, select the **Show output port** check box.

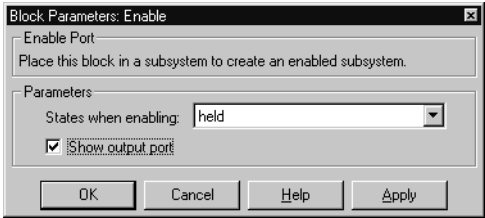

This feature allows you to pass the control signal down into the enabled subsystem, which can be useful where logic within the enabled subsystem is dependent on the value or values contained in the control signal.

Blocks an Enabled Subsystem Can Contain

An enabled subsystem can contain any block, whether continuous or discrete. Discrete blocks in an enabled subsystem execute only when the subsystem executes, and only when their sample times are synchronized with the simulation sample time. Enabled subsystems and the model use a common clock.

Note Enabled subsystems can contain Goto blocks. However, only state ports can connect to Goto blocks in an enabled subsystem. See the Simulink demo model, `c1utch`, for an example of how to use Goto blocks in an enabled subsystem.

For example, this system contains four discrete blocks and a control signal. The discrete blocks are

- Block A, which has a sample time of 0.25 second
- Block B, which has a sample time of 0.5 second
- Block C, within the enabled subsystem, which has a sample time of 0.125 second
- Block D, also within the enabled subsystem, which has a sample time of 0.25 second

The enable control signal is generated by a Pulse Generator block, labeled Signal E, which changes from 0 to 1 at 0.375 second and returns to 0 at 0.875 second.

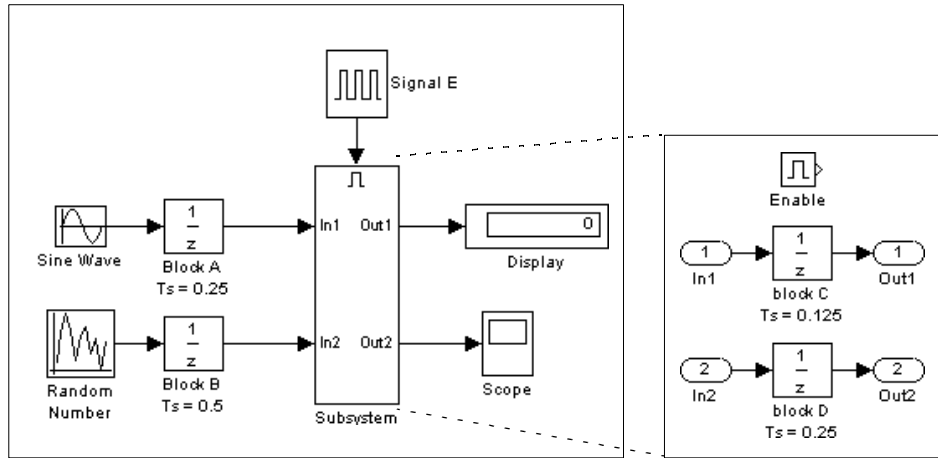

The chart below indicates when the discrete blocks execute.

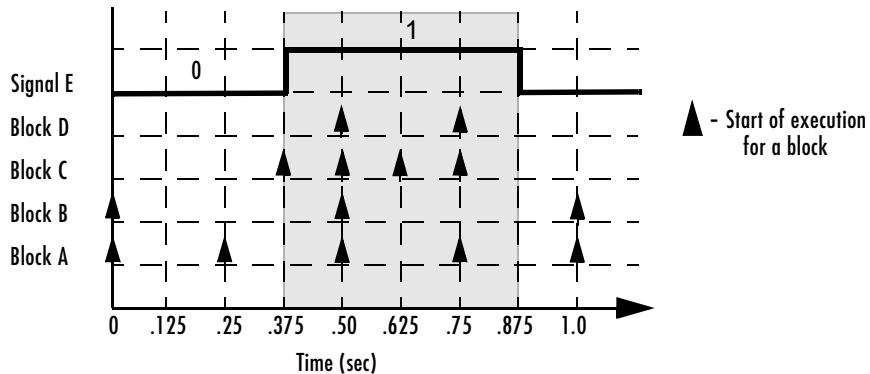

Blocks A and B execute independently of the enable control signal because they are not part of the enabled subsystem. When the enable control signal becomes positive, blocks C and D execute at their assigned sample rates until the enable

control signal becomes zero again. Note that block C does not execute at 0.875 second when the enable control signal changes to zero.

Triggered Subsystems

Triggered subsystems are subsystems that execute each time a trigger event occurs.

A triggered subsystem has a single control input, called the *trigger input*, that determines whether the subsystem executes. You can choose from three types of trigger events to force a triggered subsystem to begin execution:

- rising triggers execution of the subsystem when the control signal rises from a negative or zero value to a positive value (or zero if the initial value is negative).
- falling triggers execution of the subsystem when the control signal falls from a positive or a zero value to a negative value (or zero if the initial value is positive).
- either triggers execution of the subsystem when the signal is either rising or falling.

Note In the case of discrete systems, a signal's rising or falling from zero is considered a trigger event only if the signal has remained at zero for more than one time step preceding the rise or fall. This eliminates false triggers caused by control signal sampling.

For example, in the following timing diagram for a discrete system, a rising trigger (R) does not occur at time step 3 because the signal has remained at zero for only one time step when the rise occurs.

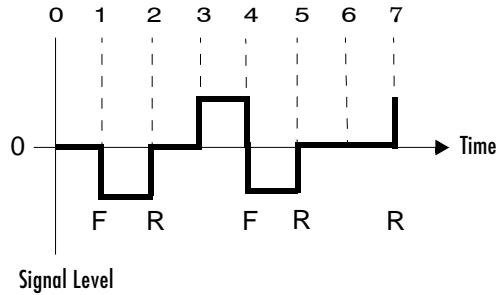

A simple example of a triggered subsystem is illustrated.

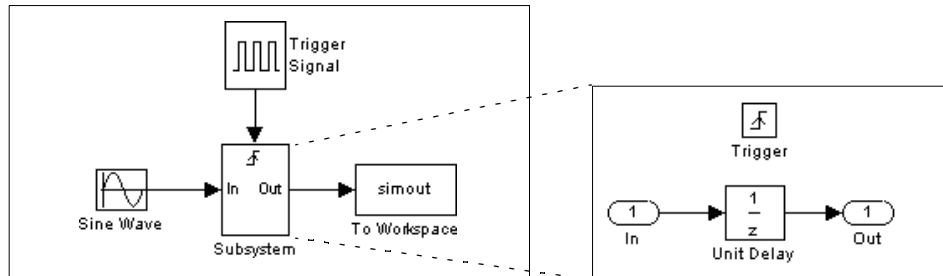

In this example, the subsystem is triggered on the rising edge of the square wave trigger control signal.

Creating a Triggered Subsystem

You create a triggered subsystem by copying the Trigger block from the Signals & Systems library into a subsystem. Simulink adds a trigger symbol and a trigger control input port to the Subsystem block.



To select the trigger type, open the Trigger block dialog box and select one of the choices for the **Trigger type** parameter, as shown in the following dialog box:

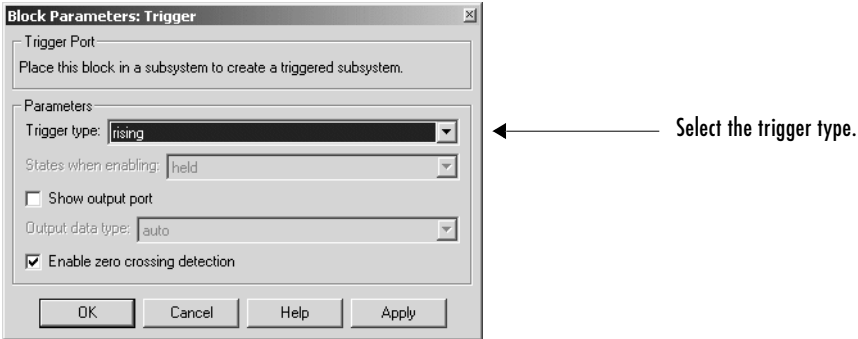

Simulink uses different symbols on the Trigger and Subsystem blocks to indicate rising and falling triggers (or either). This figure shows the trigger symbols on Subsystem blocks.



Outputs and States Between Trigger Events. Unlike enabled subsystems, triggered subsystems always hold their outputs at the last value between triggering events. Also, triggered subsystems cannot reset their states when triggered; states of any discrete blocks are held between trigger events.

Outputting the Trigger Control Signal. An option on the Trigger block dialog box lets you output the trigger control signal. To output the control signal, select the **Show output port** check box.

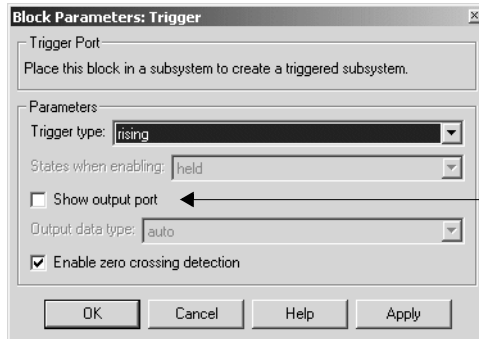

Select this check box to show the output port.

The **Output data type** field allows you to specify the data type of the output signal as `auto`, `int8`, or `double`. The `auto` option causes the data type of the output signal to be set to the data type (either `int8` or `double`) of the port to which the signal is connected.

Function-Call Subsystems

You can create a triggered subsystem whose execution is determined by logic internal to an S-function instead of by the value of a signal. These subsystems are called *function-call subsystems*. For more information about function-call subsystems, see “Function-Call Subsystems” in the “Implementing Block Features” section of *Writing S-Functions*.

Blocks That a Triggered Subsystem Can Contain

Triggered systems execute only at specific times during a simulation. As a result, the only blocks that are suitable for use in a triggered subsystem are

- Blocks with inherited sample time, such as the Logical Operator block or the Gain block
- Discrete blocks having their sample times set to `-1`, which indicates that the sample time is inherited from the driving block

Triggered and Enabled Subsystems

A third kind of conditionally executed subsystem combines both types of conditional execution. The behavior of this type of subsystem, called a *triggered and enabled* subsystem, is a combination of the enabled subsystem and the triggered subsystem, as shown by this flow diagram.

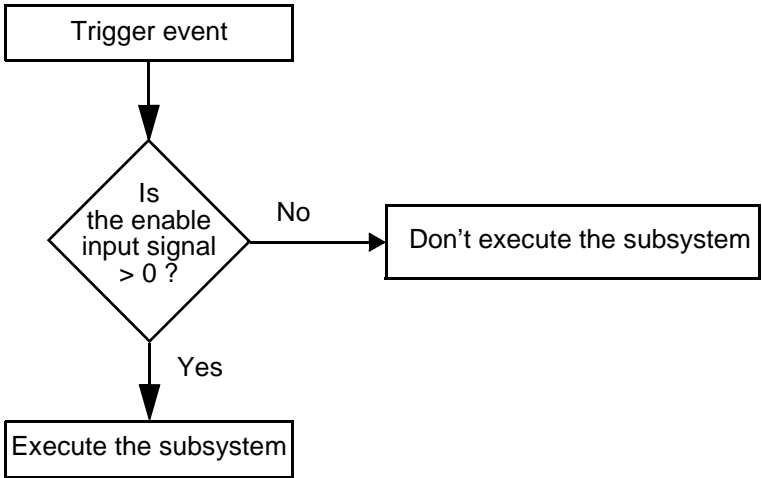

A triggered and enabled subsystem contains both an enable input port and a trigger input port. When the trigger event occurs, Simulink checks the enable input port to evaluate the enable control signal. If its value is greater than zero, Simulink executes the subsystem. If both inputs are vectors, the subsystem executes if at least one element of each vector is nonzero.

The subsystem executes once at the time step at which the trigger event occurs.

Creating a Triggered and Enabled Subsystem

You create a triggered and enabled subsystem by dragging both the Enable and Trigger blocks from the Signals & Systems library into an existing subsystem. Simulink adds enable and trigger symbols and enable and trigger and enable control inputs to the Subsystem block.



You can set output values when a triggered and enabled subsystem is disabled as you would for an enabled subsystem. For more information, see “Setting Output Values While the Subsystem Is Disabled” on page 4-27. Also, you can specify what the values of the states are when the subsystem is reenabled. See “Setting States When the Subsystem Becomes Reenabled” on page 4-28.

Set the parameters for the Enable and Trigger blocks separately. The procedures are the same as those described for the individual blocks.

A Sample Triggered and Enabled Subsystem

A simple example of a triggered and enabled subsystem is illustrated in the model below.

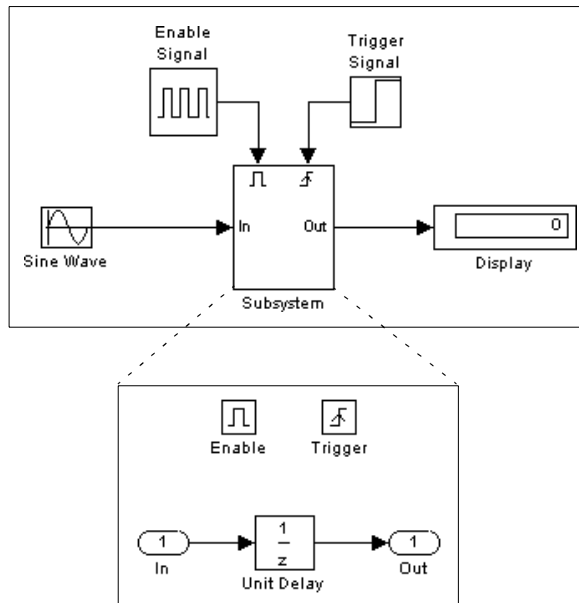

Creating Alternately Executing Subsystems

You can use conditionally executed subsystems in combination with Merge blocks to create sets of subsystems that execute alternately, depending on the current state of the model. For example, the following figure shows a model that uses two enabled blocks and a Merge block to model a full-wave rectifier, that is, a device that converts AC current to pulsating DC current.

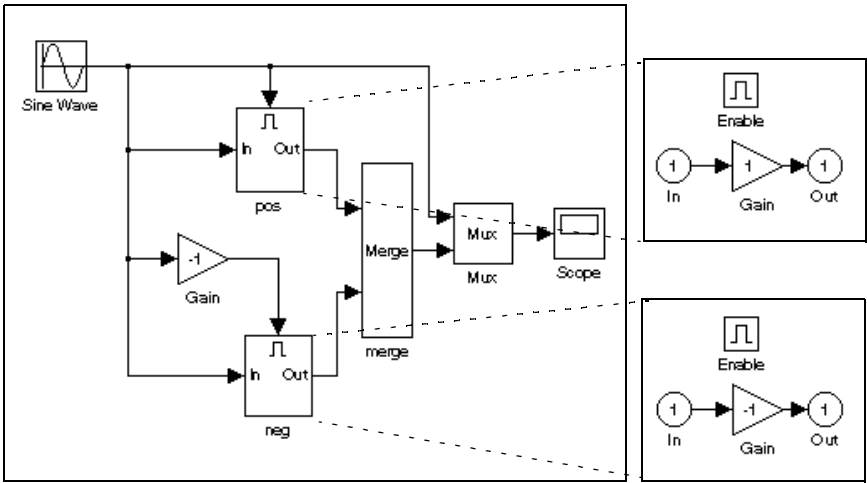

In this example, the block labeled “pos” is enabled when the AC waveform is positive; it passes the waveform unchanged to its output. The block labeled “neg” is enabled when the waveform is negative; it inverts the waveform. The Merge block passes the output of the currently enabled block to the Mux block, which passes the output, along with the original waveform, to the Scope block.

The Scope creates the following display.

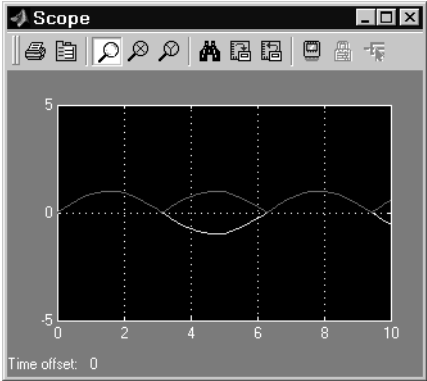

Conditional Execution Behavior

To speed simulation of a model, Simulink by default avoids unnecessary execution of blocks connected to Switch, Multiport Switch, and conditionally executed blocks, a behavior called *conditional execution (CE)* behavior. You can disable this behavior for all Switch and Multiport Switch blocks in a model or for specific conditionally executed subsystems (see “Disabling Conditional Execution Behavior” on page 4-40).

The following model illustrates conditional execution behavior.

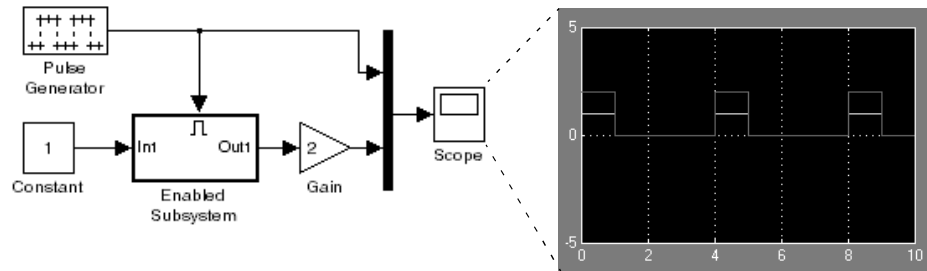

Simulink computes the outputs of the Constant block and Gain block only when the enabled subsystem executes (i.e., at time steps 0, 4, 8, and so on). This is because the output of the Constant block is required and the input of the Gain block changes only when the enabled subsystem executes. When CE behavior is off, Simulink computes the outputs of the Constant and Gain blocks at every time step, regardless of whether the outputs are needed or change.

In this example, Simulink regards the enabled subsystem as defining an execution context for the Constant and Gain blocks. Although the blocks reside graphically in the model’s root system, Simulink invokes the blocks’ methods during simulation as if the blocks reside in the enabled subsystem.

Propagating Execution Contexts

In general, Simulink defines an *execution context* as a set of blocks to be executed as a unit. At model compilation time, Simulink associates an execution context with the model’s root system and with each of its nonvirtual subsystems. Initially, the execution context of the root system and each nonvirtual subsystem is simply the blocks that it contains.

When compiling a model, Simulink examines each block in the model to determine whether it meets the following conditions:

- Its output is required only by a conditionally executed subsystem or its input changes only as a result of the execution of a conditionally executed.
- The subsystem's execution context can propagate across its boundaries.
- The output of the block is not a testpoint (see “Working with Test Points” on page 6-35).
- The block is allowed to inherit its conditional execution context.
Simulink does not allow some built-in blocks, e.g., the Delay block, ever to inherit their execution context. Also, S-Function blocks can inherit their execution context only if they specify the `SS_OPTION_CAN_BE_CALLED_CONDITIONALLY` option.
- The block is not a multirate block.
- Its sample time is inherited (-1) or constant (inf).

If a block meets these conditions and execution context propagation is enabled for the associated conditionally executed subsystem (see “Disabling Conditional Execution Behavior” on page 4-40), Simulink moves the block into the execution context of the subsystem. This ensures that the block's methods are executed during the simulation loop only when the corresponding conditionally executed subsystem executes.

Behavior for Switch Blocks

This behavior treats the input branches of a Switch or Multipoint Switch block as invisible, conditionally executed subsystems, each of which has its own execution context that is enabled only when the switch's control input selects the corresponding data input. As a result, switch branches execute only when selected by switch control inputs.

Displaying Execution Contexts

To determine the execution context to which a block belongs, select **Sorted order** from the model window's **Format** menu. Simulink displays the sorted order index for each block in the model in the upper right corner of the block. The index has the format `s:b`, where `s` specifies the subsystem to whose execution context the block, `b`, belongs.

Simulink also expands the sorted order index of conditionally executed subsystems to include the system ID of the subsystem itself in curly brackets as illustrated in the following figure.

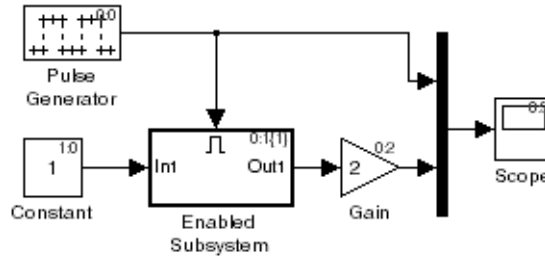

In this example, the sorted order index of the enabled subsystem is 0:1{1}. The 0 indicates that the enabled subsystem resides in the model's root system. The first 1 indicates that the enabled subsystem is the second block on the root system's sorted list (zero-based indexing). The 1 in curly brackets indicates that the system index of the enabled subsystem itself is 1. Thus any block whose system index is 1 belongs to the execution context of the enabled subsystem and hence executes when it does. For example, the Constant block's index, 1:0, indicates that it is the first block on the sorted list of the enabled subsystem, even though it resides in the root system.

Disabling Conditional Execution Behavior

To disable conditional execution behavior for all Switch and Multiport Switch blocks in a model, turn off the Conditional input branch execution optimization on the **Optimization** pane of the **Configuration Parameters** dialog box (see "The Optimization Pane" on page 10-43). To disable conditional execution behavior for a specific conditionally executed subsystem, uncheck the **Propagate execution context across subsystem boundary** option on the subsystem's parameter dialog box.

Even if this option is enabled, a subsystem's execution context cannot propagate across its boundaries under either of the following circumstances:

- The subsystem is a triggered subsystem with a latched input port.

- The subsystem has one or more output ports that specify an initial condition, i.e., whose initial condition is other than []. In this case, a block connected to the subsystem's output cannot inherit the subsystem's execution context.

Displaying Execution Context Bars

Simulink can optionally display bars next to the ports of subsystems across which execution contexts cannot propagate, i.e., on subsystems from which no block can inherit its execution context.

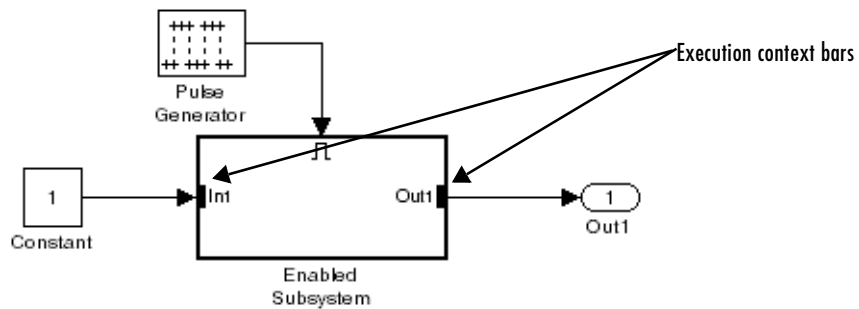

To display the bars, select **Execution context indicator** from the model editor's **Format -> Block Displays** menu.

Modeling with Control Flow Blocks

The control flow blocks are used to implement the logic of the following C-like control flow statements in Simulink:

- for
- if-else
- switch
- while (includes while and do-while control flow statements)

Although all the preceding control flow statements are implementable in Stateflow[®], these blocks are intended to provide Simulink users with tools that meet their needs for simpler logical requirements.

Creating Conditional Control Flow Statements

You create C-like conditional control flow statements using ordinary subsystems and the following blocks from the Subsystems library.

C Statement	Blocks Used
if-else	If, Action Port
switch	Switch Case, Action Port

If-Else Control Flow Statements

The following diagram depicts a generalized if-else control flow statement implementation in Simulink.

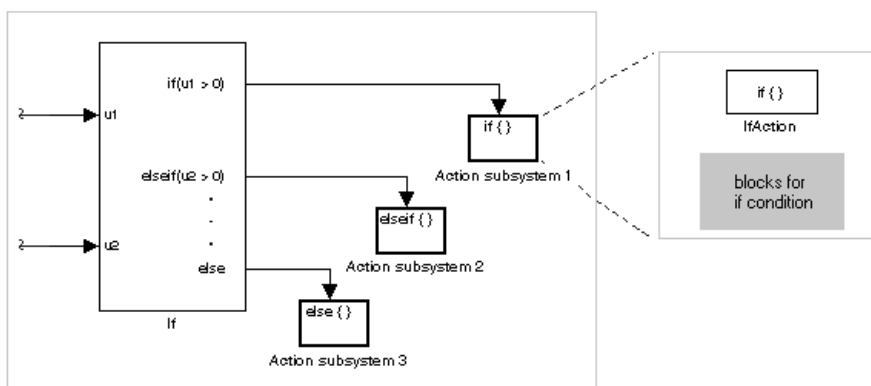

Construct a Simulink if-else control flow statement as follows:

- Provide data inputs to the If block for constructing if-else conditions.
Inputs to the If block are set in the If block properties dialog. Internally, they are designated as u_1 , u_2 , ..., u_n and are used to construct output conditions.
- Set output port if-else conditions for the If block.
Output ports for the If block are also set in its properties dialog. You use the input values u_1 , u_2 , ..., u_n to express conditions for the if, elseif, and else condition fields in the dialog. Of these, only the if field is required. You can enter multiple elseif conditions and select a check box to enable the else condition.
- Connect each condition output port to an Action subsystem.
Each if, elseif, and else condition output port on the If block is connected to a subsystem to be executed if the port's case is true. You create these subsystems by placing an Action Port block in a subsystem. This creates an atomic Action subsystem with a port named Action, which you then connect to a condition on the If block. Once connected, the subsystem takes on the identity of the condition it is connected to and behaves like an enabled subsystem.

For more detailed information, see the reference topics for the If and Action Port blocks.

Note All blocks in an Action subsystem driven by an If or Switch Case block must run at the same rate as the driving block.

Switch Control Flow Statements

The following diagram depicts a generalized switch control flow statement implementation in Simulink.

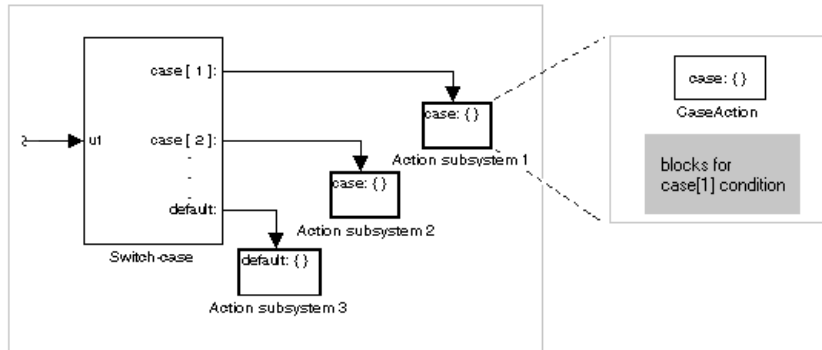

Construct a Simulink switch control flow statement as follows:

- Provide a data input to the argument input of the Switch Case block.
The input to the Switch Case block is the argument to the switch control flow statement. This value determines the appropriate case to execute. Noninteger inputs to this port are truncated.
- Add cases to the Switch Case block based on the numeric value of the argument input.
You add cases to the Switch Case block through the properties dialog of the Switch Case block. Cases can be single or multivalued. You can also add an optional default case, which is true if no other cases are true. Once added, these cases appear as output ports on the Switch Case block.

- Connect each Switch Case block case output port to an Action subsystem. Each case output of the Switch Case block is connected to a subsystem to be executed if the port's case is true. You create these subsystems by placing an Action Port block in a subsystem. This creates an atomic subsystem with a port named Action, which you then connect to a condition on the Switch Case block. Once connected, the subsystem takes on the identity of the condition and behaves like an enabled subsystem. Place all the block programming executed for that case in this subsystem.

For more detailed information, see the reference topics for the Switch Case and Action Port blocks.

Note After the subsystem for a particular case is executed, an implied break is executed that exits the switch control flow statement altogether. Simulink switch control flow statement implementations do not exhibit “fall through” behavior like C switch statements.

Creating Iterator Control Flow Statements

You create C-like iterator control flow statements using subsystems and the following blocks from the Subsystems library.

C Statement	Blocks Used
do-while	While Iterator
for	For Iterator
while	While Iterator

While Control Flow Statements

The following diagram depicts a generalized C-like `while` control flow statement implementation in Simulink.

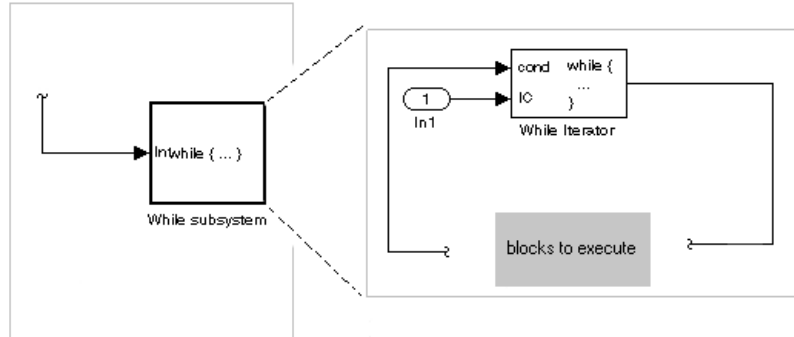

In a Simulink `while` control flow statement, the While Iterator block iterates the contents of a While subsystem, an atomic subsystem. For each iteration of the While Iterator block, the block programming of the While subsystem executes one complete path through its blocks.

Construct a Simulink `while` control flow statement as follows:

- Place a While Iterator block in a subsystem.

The host subsystem becomes a `while` control flow statement as indicated by its new label, `while { ... }`. These subsystems behave like triggered subsystems. This subsystem is host to the block programming you want to iterate with the While Iterator block.

- Provide a data input for the initial condition data input port of the While Iterator block.

The While Iterator block requires an initial condition data input (labeled IC) for its first iteration. This must originate outside the While subsystem. If this value is nonzero, the first iteration takes place.

- Provide data input for the conditions port of the While Iterator block.

Conditions for the remaining iterations are passed to the data input port labeled `cond`. Input for this port must originate inside the While subsystem.

- You can set the While Iterator block to output its iterator value through its properties dialog.

The iterator value is 1 for the first iteration and is incremented by 1 for each succeeding iteration.

- You can change the iteration of the While Iterator block to do-while through its properties dialog.

This changes the label of the host subsystem to do {...} while. With a do-while iteration, the While Iteration block no longer has an initial condition (IC) port, because all blocks in the subsystem are executed once before the condition port (labeled cond) is checked.

For specific details, see the reference topic for the While Iterator block.

For Control Flow Statements

The following diagram depicts a generalized for control flow statement implementation in Simulink.

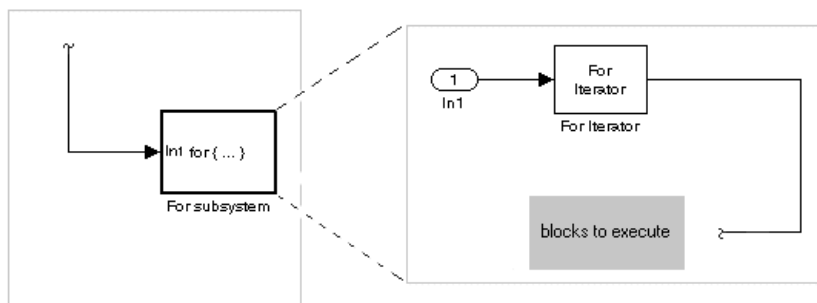

In a Simulink for control flow statement, the For Iterator block iterates the contents of a For Iterator Subsystem, an atomic subsystem. For each iteration of the For Iterator block, the block programming of the For Iterator Subsystem executes one complete path through its blocks.

Construct a Simulink for control flow statement as follows:

- Drag a For Iterator Subsystem block from the Library Browser or Library window into your model.

- You can set the For Iterator block to take external or internal input for the number of iterations it executes.

Through the properties dialog of the For Iterator block you can set it to take input for the number of iterations through the port labeled N. This input must come from outside the For Iterator Subsystem.

You can also set the number of iterations directly in the properties dialog.

- You can set the For Iterator block to output its iterator value for use in the block programming of the For Iterator Subsystem.

The iterator value is 1 for the first iteration and is incremented by 1 for each succeeding iteration.

The For Iterator block works well with the Assignment block to reassign values in a vector or matrix. This is demonstrated in the following example. Note the matrix dimensions in the data being passed.

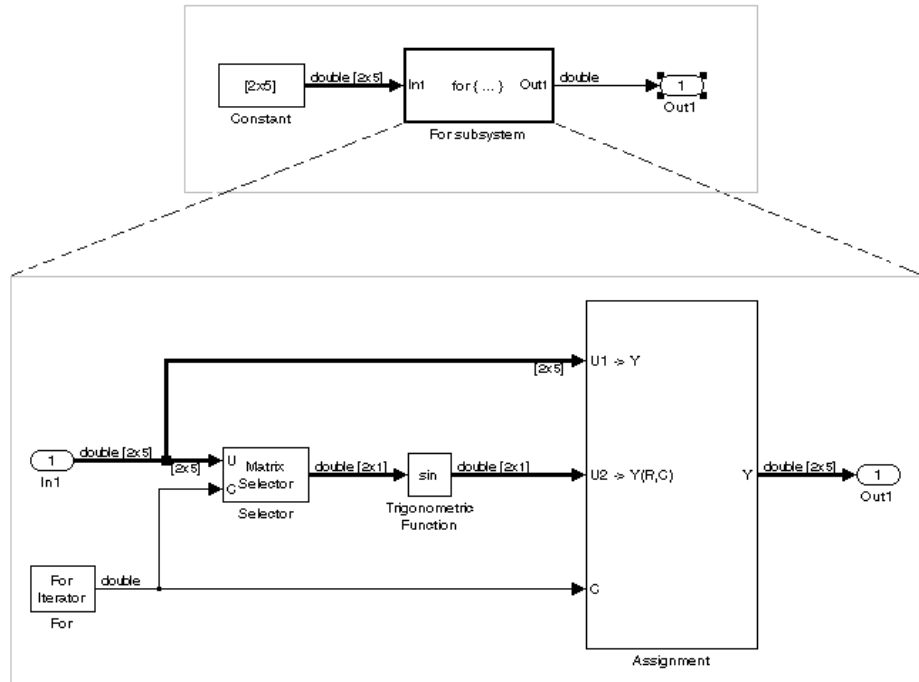

The above example outputs the sin value of an input 2-by-5 matrix (2 rows, 5 columns) using a For subsystem containing an Assignment block. The process is as follows:

- 1 A 2-by-5 matrix is input to the Selector block and the Assignment block.
- 2 The Selector block strips off a 2-by-1 matrix from the input matrix at the column value indicated by the current iteration value of the For Iterator block.
- 3 The sine of the 2-by-1 matrix is taken.
- 4 The sine value 2-by-1 matrix is passed to an Assignment block.
- 5 The Assignment block, which takes the original 2-by-5 matrix as one of its inputs, assigns the 2-by-1 matrix back into the original matrix at the column location indicated by the iteration value.

The rows specified for reassignment in the property dialog for the Assignment block in the above example are [1,2]. Because there are only two rows in the original matrix, you could also have specified -1 for the rows, i.e., all rows.

Note Experienced Simulink users will note that the sin block is already capable of taking the sine of a matrix. The above example uses the sin block only as an example of changing each element of a matrix with the collaboration of an Assignment block and a For Iterator block.

Comparing Stateflow and Control Flow Statements

Stateflow already possesses the logical capabilities of the Simulink control flow statements. It can call Function-Call subsystems (see “Function-Call Subsystems” on page 4-34) on condition or iteratively. However, since Stateflow provides a great deal more in logical sophistication, if your requirements are simpler, you might find the capabilities of the Simulink control flow blocks sufficient for your needs. In addition, the control flow statements offer a few advantages, which are listed in the following topics.

Sample Times

The Function-Call subsystems that Stateflow can call are triggered subsystems. Triggered subsystems inherit their sample times from the calling block. However, the Action subsystems used in `if-else` and `switch` control flow statements and the `While` and `For` subsystems that make up `while` and `for` control flow statements are enabled subsystems. Enabled subsystems can have their own sample times independent of the calling block. This also allows you to use more categories of blocks in your iterated subsystem than in a Function-Call subsystem.

Resetting of States When Reenabled

Simulink control flow statement blocks allow you to retain or reset (to their initial values) the values of states for Action, For, and While subsystems when they are reenabled. For detailed information, see the references for the `While Iterator` and `For Iterator` blocks regarding the parameter **States when starting** and the reference for the `Action Port` block regarding the parameter **States when execution is resumed**.

Using Stateflow with the Control Flow Blocks

You might want to consider the possibility of using Stateflow and the Simulink control flow blocks together. The following sections contain some examples that give you a few suggestions on how to combine the two.

Using Stateflow with If-Else or Switch Subsystems. In the following model, Stateflow places one of a variety of values in a Stateflow data object. Upon chart termination, a Simulink `if` control flow statement uses that data to make a conditional decision.

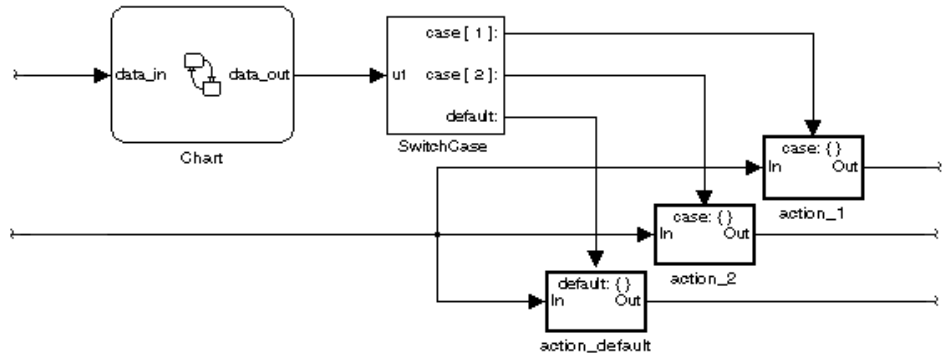

In this case, control is given to a Switch Case block, which uses the value to choose one of several case subsystems to execute.

Using Stateflow with While Subsystems. In the following diagram, Stateflow computes the value of a data object that is available to a condition input of a While Iterator block in do-while mode.

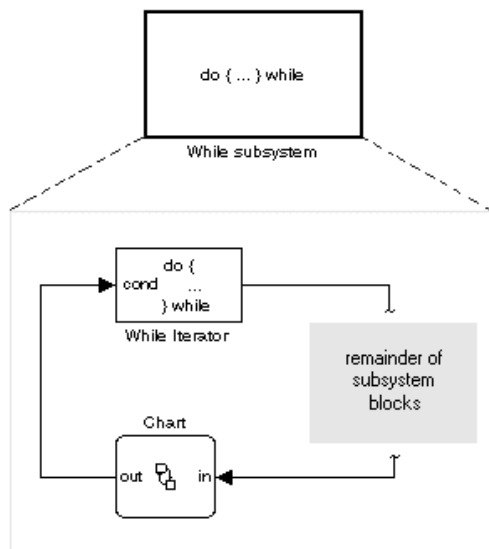

The While Iterator block has iterative control over its host subsystem, which includes the Stateflow Chart block. In do-while mode, the While block is guaranteed to operate for its first iteration value ($= 1$). During that time, the Stateflow chart is awakened and sets a data value used by the While Iterator block, which is evaluated as a condition for the next while iteration.

In the following diagram, the While block is now set in while mode. In this mode, the While Iterator block must have input to its initial condition port in order to execute its first iteration value. This value must come from outside the While subsystem.

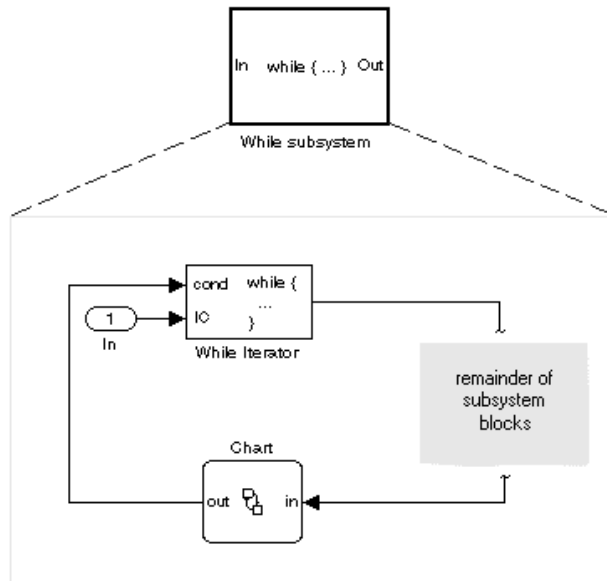

If the initial condition is true, the While Iterator block wakes up the Stateflow chart and executes it to termination. During that time the Stateflow chart sets data, which the While Iterator condition port uses as a condition for the next iteration.

Referencing Models

Simulink allows you to include models in other models as blocks, a feature called model referencing. You create references to other models by creating instances of Model blocks in a parent model (see “Creating a Model Reference” on page 4-54). Each instance of a Model block in a parent model represents a reference to another model called a referenced model. A Model block displays inputs and outputs corresponding to the root-level inputs and outputs of the model it references, enabling you to incorporate the referenced model into the block diagram of the parent model.

During simulation, Simulink invokes an automatically generated S-function, called the referenced model’s simulation target, to compute the Model block’s outputs as needed. If the simulation target does not exist at the beginning of a simulation, Simulink generates it from the referenced model. If the simulation target does exist, Simulink checks whether the referenced model has changed significantly since the target was last generated. If so, Simulink regenerates the target to reflect the changes to the referenced model (see “Building Simulation Targets” on page 4-66 for more information).

Note Real-Time Workshop similarly generates library modules, called Real-Time Workshop targets, for the referenced models and a stand-alone executable for the root model, with the parent target invoking the referenced model targets to compute the referenced model outputs as needed. See the Real-Time Workshop documentation for more information.

A referenced model can itself reference other models. The topmost model in a hierarchy of model references is called the root model. A parent model can contain multiple references to the same model as long as the referenced model does not define global data. You can parameterize model references such that each reference to a model can specify different values for variables that define the model’s behavior (see “Parameterizing Model References” on page 4-56 for more information).

Simulink includes a set of demos that illustrate various aspects of model referencing. To run the demos from the MATLAB command line, enter

```
mdlrefdemos
```

Model Referencing Versus Subsystems

Like subsystems, model referencing allows you to organize large models hierarchically, with Model blocks representing major subsystems. However, model referencing has significant advantages over subsystems in many applications. The advantages include:

- **Modular development**
You can develop the referenced model independently from the models in which it is used.
- **Inclusion by reference**
You can reference a model multiple times in another model without having to make redundant copies and multiple models can reference the same model.
- **Incremental loading**
The referenced model is not loaded until it is needed, speeding up model loading (see “Incremental Loading” on page 4-65 for more information).
- **Incremental code generation**
Simulink and Real-Time Workshop create binaries to be used in simulations and stand-alone applications to compute the outputs of the included blocks. If the binaries are up-to-date, that is, the binaries are not older than the models from which they were generated, no code generation occurs when models that reference them are simulated or compiled.

Simulink provides a tool to convert atomic subsystems to stand-alone models and to reconfigure the root model by replacing the subsystems with Model blocks. For further information, see “Converting Subsystems to Model References” on page 4-67. It also provides a command, `find_mdirefs`, to find all models directly or indirectly referenced by a given model.

Creating a Model Reference

To create a reference to a model in another model:

- 1 If the model is not on the MATLAB path, add it to the MATLAB path.
- 2 Enable the parent model’s **Inline parameters** optimization if it is not already enabled (see “Inline parameters” on page 10-44).

- 3 Create an instance of the Model block in the parent model (for example, by opening the Library Browser and dragging an instance from the Ports & Subsystems block library to the parent model).

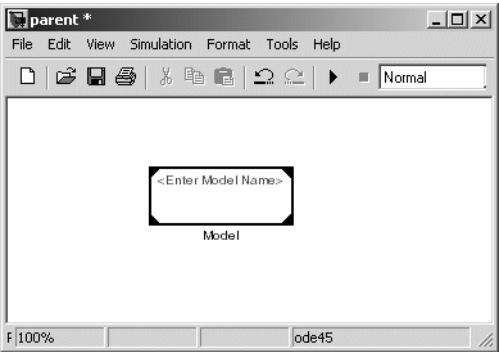

- 4 Open the newly created Model block’s parameter dialog box.

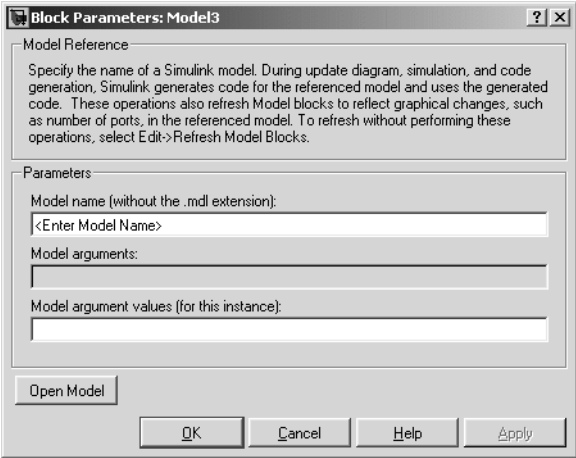

- 5 Enter the name of the referenced model in the parameter dialog box’s Model name field. The referenced model must be configured to use a fixed-step solver.
- 6 Click OK to apply the model name and close the dialog box.

If the referenced model contains any root-level inputs or outputs, Simulink displays corresponding input and output ports on the Model block instance that you have created. Use these ports to connect the reference model to other ports in the parent model.

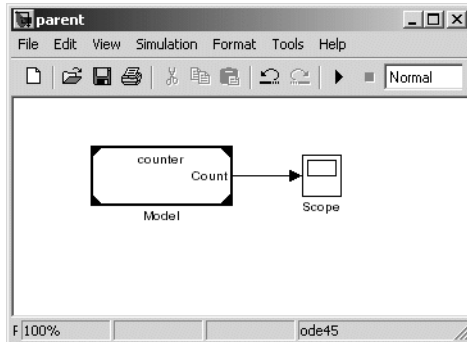

Note See “Referenced Model I/O” on page 4-63 for information on connecting blocks in a parent model to a model that has bus inputs or outputs.

Opening a Referenced Model

To open a referenced model, select the Model block that references the model. Then select **Open Model** from the model editor’s **Edit** menu or from the block’s context menu.

Parameterizing Model References

Simulink allows you to parameterize references to models, i.e., use workspace variables to determine their behavior. You can parameterize a model in the following ways:

- Use *global nontunable parameters* in the MATLAB workspace or in a model workspace to determine the behavior of all references to a given model. A *global nontunable parameter* is a MATLAB variable or a Simulink.Parameter object whose storage class is auto. The value of such a variable cannot be changed during simulation.

- Use *global tunable parameters* in the MATLAB workspace to determine the behavior of all references to a given model in the model.

A *global tunable parameter* is a parameter specified by an object of `Simulink.Parameter` class that has a storage class other than `auto`. The value of such a variable can be changed during simulation, allowing you to change the behavior of the referenced models.

- Use model arguments in the model to specify different behavior for different references to the same model (see next section).

Model Referencing and the Inline Parameters Optimization

Simulink does not support the off setting of the inline parameters optimization (see “Inline parameters” on page 10-44) for models that contain Model blocks. Simulink ignores the settings in the **Tunable Parameter** dialog box (see “Model Parameter Configuration Dialog Box” on page 10-47) for models that contain Model blocks and for referenced models. To help you convert existing models to model referencing, Simulink provides a command that converts tunable parameters specified in the **Tunable Parameter** dialog box, which do not work with model referencing, to global tunable parameters that do work with model referencing. Type

```
help tunablevars2parameterobjects
```

at the MATLAB command line for more information.

Using Model Arguments

Model arguments let you create references to the same model that behave differently. For example, suppose you want each reference to a counter model to be able to specify initial and increment values for the counter where the specified values can differ from reference to reference. Using model arguments to parameterize references to the counter model allows you to do this.

Note Run the `mdlref_paramargs` demo to see parameterized model references in action.

Using model arguments requires that you

- Declare model workspace variables that determine the model's behavior as model arguments
- Assign values to the model arguments in each reference to the parameterized model

The following sections explain how to perform these tasks.

Declaring Model Arguments

To declare some or all of a model's model workspace variables as model arguments:

- 1 Open the referenced model.
- 2 Open the Model Explorer.
- 3 Select the model's workspace in the Model Explorer.

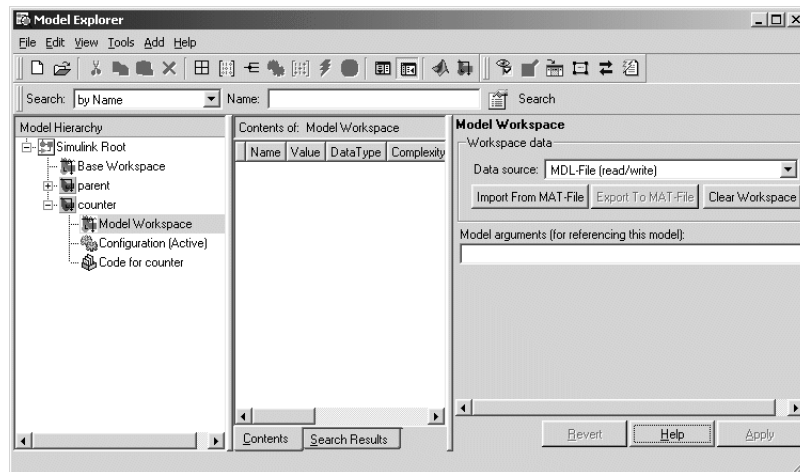

- 4 If you have not already done so, use the Model Explorer to create MATLAB variables in the model's workspace that determine the model's behavior.

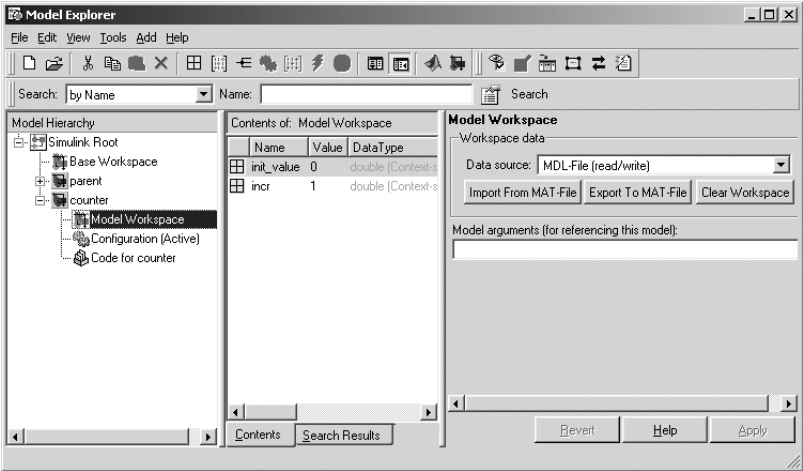

- 5 Enter the names of the workspace variables that you want to declare as model arguments as a comma-separated list in the **Model arguments** field in the model workspace's dialog box.

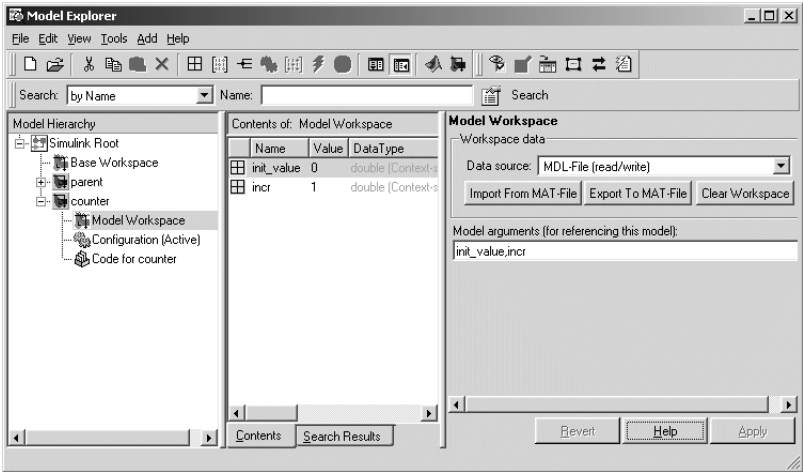

- 6 Click the **Apply** button on the dialog box to confirm the entered names.

Note If a model does not declare a variable in its workspace as a model argument, the variable has the same value in every reference to the model and cannot be tuned from a parent model. For example, suppose that a model defines a variable *k* in its workspace but does not declare it as a model argument. Further, suppose that the model assigns a value of 5 to *k* in its workspace. Then the value of *k* will be 5 in every reference to the model in other models.

Assigning Values to Model Arguments

If a model declares model arguments, you must assign values to the model arguments in each reference to the model, i.e., in each Model block that references the model.

To assign values to a model's model arguments in a Model block that references the model:

- 1 Open the Model block's parameter dialog box.

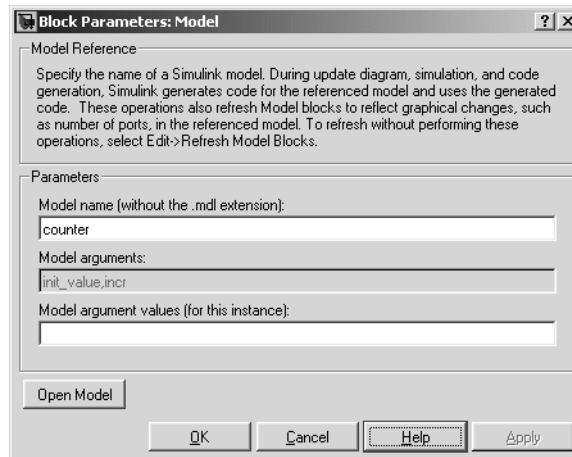

- 2 Enter a comma-delimited list of values for the parameter arguments in the **Model argument values** field in the same order in which the arguments appear in the **Model arguments** field.

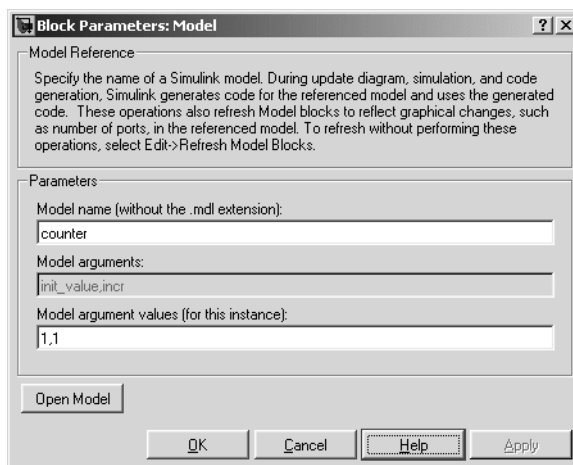

You can enter the values as literal values, variable names, MATLAB expressions, and Simulink parameter objects. The value for a particular argument must have the same dimensions and data and numeric type as the model workspace variable that defines the argument.

Model Block Sample Times

The sample times of a Model block are the sample times of the model that it references. If the referenced model needs to run at specific rates, the referenced model's simulation target specifies the required rates. Otherwise, the target specifies that the referenced model inherits its sample time from the parent model. Specifically, a referenced model inherits its sample time if all the following conditions are true:

- None of its blocks specify sample times (other than inherited and constant).
- It does not have any continuous states.
- It does not contain any blocks that use absolute time.
- It specifies a fixed-step solver but not a fixed step size.

- After sample time propagation, it has only one sample time (not counting constant and triggered sample time).
- It does not contain any blocks that preclude sample time inheritance (see “Blocks That Preclude Sample-Time Inheritance” on page 4-62)

You can use a referenced model that inherits its sample time anywhere in a parent model. By contrast, you cannot use a referenced model that has intrinsic sample times in a triggered, function call, or for an iterator subsystem. Further, to avoid rate transition errors, you must ensure that blocks connected to a referenced model with intrinsic samples times operate at the same rates as the referenced model.

To determine whether a referenced model inherits its sample time, set the **Periodic sample time constraint** on the **Solver** configuration parameters dialog pane to **Ensure sample time independent** (see “Periodic sample time constraint” on page 10-36). If the model is unable to inherit sample times, this setting causes Simulink to display an error message when generating the referenced model’s simulation (or Real-Time Workshop) target. To determine the intrinsic sample time of a referenced model (or the fastest intrinsic sample time for multirate referenced models), first update a model that references it. Then select a Model block that references the referenced model and enter the following command at the MATLAB command line:

```
get_param(gcf, 'CompiledSampleTime')
```

Blocks That Preclude Sample-Time Inheritance

Using a block whose output depends on an inherited sample time in a referenced model can cause a simulation to produce unexpected or erroneous results. For this reason, when building a simulation target for a model that does not need to run at a specified rate, Simulink checks whether the model contains any blocks, including any S-Function blocks, whose outputs are functions of the inherited simulation time. If so, Simulink generates a simulation target that specifies a default sample time and displays an error if you have set the **Periodic sample time constraint** on the **Solver** configuration parameters dialog pane to **Ensure sample time independent** (see “Periodic sample time constraint” on page 10-36).

The outputs of the following built-in blocks depend on their inherited sample time and hence preclude a referenced model from inheriting its sample time from the parent model:

- Discrete-Time Integrator
- From Workspace (if it has input data that contains time)
- Probe (if probing sample time)
- Rate Limiter
- Sine Wave

Simulink assumes that the output of an S-function does not depend on inherited sample time unless the S-function explicitly declares the contrary (see “Writing S-Functions” for information on how to create S-functions that declare whether their output depends on their inherited sample time). Thus, to avoid simulation errors with referenced models that inherit their sample time, you need to take care not to include S-functions in the referenced models that fail to declare whether their output depends on their inherited sample time. Simulink by default warns you if your model contains such blocks when you update or simulate the model (see “Unspecified inheritability of sample time” on page 10-50).

Referenced Model I/O

Simulink imposes the following restrictions on connecting signals to the inputs and outputs of Model blocks.

Bus I/O Limitations

A parent model can reference a model with bus input or output ports only if each bus port meets the following conditions:

- The port is defined by a bus object, i.e., an instance of `Simulink.Bus` class specified as the value of the port block’s **Bus object** parameter.
- The bus object is defined in a workspace that is visible from both the parent and the referenced model, e.g., the MATLAB workspace for a model referenced by a root model.

Similarly, the bus connected to a bus input port of a referenced model must be defined by the same bus object that defines the bus input, i.e., the bus must be created by a Bus Creator block whose Bus object parameter is set to the bus

object as is the Inport of the referenced model. This explains why the bus object must be visible to both the parent and the referenced model.

Index I/O Limitations

In some circumstances, Simulink does not propagate 0- or 1-based indexing information to the root-level ports connected to blocks in the referenced model that accept indices, e.g., the Assignment block, or produce indices, e.g., the For Iterator block. In particular, if a root-level input port is connected to index inputs in the referenced model whose 0- or 1-based indexing properties differ, Simulink does not set the 0- or 1-based indexing property of the input port. Similarly, if a root-level output port of the referenced model is connected to index outputs in the model that have different 0- or 1-based indexing settings, Simulink does not set the 0- or 1-based indexing property of the root-level output port. This can cause Simulink to miss incompatible index connections when the model is referenced by another model.

Matching I/O Rates

In a referenced model, the first nonvirtual block connected downstream from a root-level Inport of the referenced model and the first nonvirtual block connected upstream from a root-level Outport must have the sample time as the Inport or Outport block. If the rates do not match when you update or start a simulation of the referencing model, Simulink halts and displays an error. You can use Rate Transition blocks to match the root-level input and output sample times as illustrated in the following diagram.

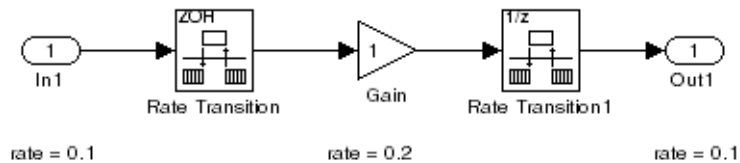

Model Interfaces

A referenced model's interface consists of its input and output ports and its parameter arguments. Model block instances depict the interfaces of the models they reference.

Incremental Loading

Simulink takes advantage of this fact to defer loading of referenced models until you update or simulate the model that references them. This feature, called incremental loading, allows you to begin editing a model before it is completely loaded, a useful capability when you need to make changes to large, complex models.

Note To take advantage of incremental loading, models referenced by Model blocks must have been opened and saved at least once in Release 14 (or a later version) of Simulink.

Refreshing Model Blocks

Refreshing Model blocks refers to the process of updating them to reflect graphical changes in the interfaces of the models they reference. To refresh all of a model's Model blocks, select **Refresh Model Blocks** from the model's **Edit** menu. To update a specific Model block, select **Refresh** from the block's context (pop-up) menu.

You should refresh a Model block instance if the model that it references has changed since the block was created or since it was last refreshed and the changes affect the block's graphical appearance, for example, the referenced model gained or lost a port. Simulink provides diagnostics that enable you to detect changes in the interfaces of referenced models that could require refreshing the Model blocks that reference them. The diagnostics include

- Model block version mismatch (see “Model block version mismatch” on page 10-60)
- I/O port and parameter mismatch (see “Port and parameter mismatch” on page 10-61)

Displaying Referenced Model Version Numbers

To display the version numbers of the models referenced by a model (see “Managing Model Versions” on page 4-103), select Model block version from the

Block displays submenu of the parent model's Format menu. Simulink displays the version numbers in the icons of the corresponding Model block instances.

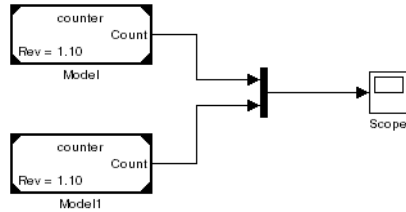

The version number displayed on a Model block's icon refers to the version of the model used to create the block or refresh the block when it was last refreshed.

Building Simulation Targets

A simulation target is an S-function that computes the outputs of a referenced model during simulation of the model's parent. You can command Simulink to generate simulation targets for model references at any time by updating the model's diagram or by executing the `slbuild` command at the MATLAB command line or you can let Simulink determine whether and when to build the simulation targets. If the simulation target for a referenced model does not exist at the start of a simulation, Simulink generates the target. Subsequently, if the files or workspace variables used to build the target change, it may be necessary to rebuild the target to reflect the changes, depending on whether the changes affect target outputs. You can let Simulink determine whether to rebuild existing targets or specify that Simulink always or never rebuild targets at the beginning of a simulation (see "Rebuild options for all referenced models" on page 10-67).

While generating a target, Simulink displays status messages at the MATLAB command line to enable you to monitor the target generation process, which entails generating and compiling code and linking the compiled target code with compiled code from standard code libraries to create an executable file.

Simulink creates simulation targets in the current working directory. It stores intermediate files used to generate the simulation targets in separate subdirectories of a subdirectory of the working directory named `slprj`. If the `slprj` directory does not exist, Simulink creates it. The Simulink Accelerator

and Real-Time Workshop also use the `s1prj` subdirectory of the current working directory to store intermediate files used to build acceleration targets and stand-alone targets, respectively.

Project Directories

The policy of having all Simulink-related products store generated files in the same subdirectory of the current work directory makes it easy for you to keep all the generated files for a given project together and separate from generated files belonging to other projects. All that is required is that you create a separate directory for each project and make the directory for a given project the current working directory when you are working on the project.

Converting Subsystems to Model References

Converting an existing model to use model referencing can be a time-consuming and error-prone task if done by hand. Execute

```
mdlref_conversion
```

at the MATLAB command line for a demonstration of a way to automate this task.

Model Discretizer

The Model Discretizer selectively replaces continuous Simulink blocks with discrete equivalents. Discretization is a critical step in digital controller design and for hardware in-the-loop simulations. You can use this tool to prepare continuous models for use with the Real-Time Workshop Embedded Coder, which supports only discrete blocks.

The Model Discretizer enables you to

- Identify a model's continuous blocks.
- Change a block's parameters from continuous to discrete.
- Apply discretization settings to all continuous blocks in the model or to selected blocks.
- Create configurable subsystems that contain multiple discretization candidates along with the original continuous block(s).
- Switch among the different discretization candidates and evaluate the resulting model simulations.

Requirements

To use the Model Discretizer, you must have the Control System Toolbox, Version 5.2, installed.

Start the Model Discretizer

To open the tool, select **Model Discretizer** from the **Tools** menu in a Simulink model. This displays the **Simulink Model Discretizer** window.

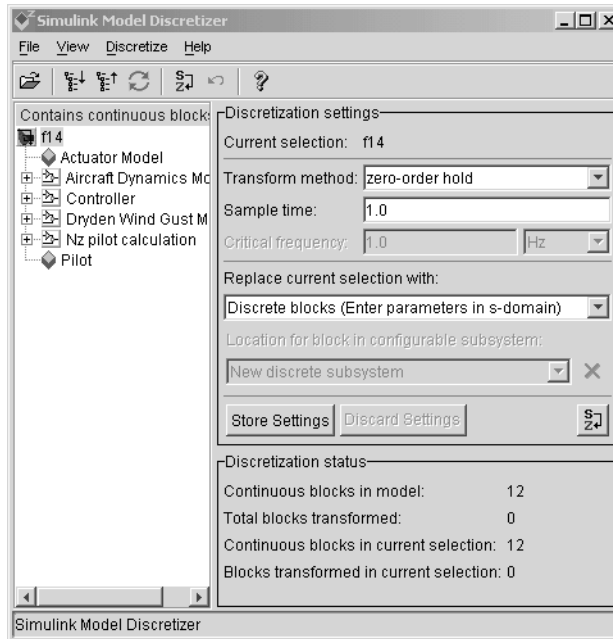

Alternatively, you can open the Model Discretizer from the MATLAB command window using the `slmdliscui` function.

The following command opens the **Simulink Model Discretizer** window with the `f14` model.

```
slmdliscui('f14')
```

To open a new Simulink model or library from the Model Discretizer, select **Load model** from the **File** menu.

Specify the Transform Method

The transform method specifies the type of algorithms used in the discretization. For more information on the different transform methods, see

Continuous/Discrete Conversions of LTI Models in the Control Systems Toolbox documentation.

The **Transform method** drop-down list contains the following options:

- zero-order hold
Zero-order hold on the inputs.
- first-order hold
Linear interpolation of inputs.
- tustin
Bilinear (Tustin) approximation.
- tustin with prewarping
Tustin approximation with frequency prewarping.
- matched pole-zero
Matched pole-zero method (for SISO systems only).

Specify the Sample Time

Enter the sample time in the **Sample time** field.

You can specify an offset time by entering a two-element vector for discrete blocks or configurable subsystems. The first element is the sample time and the second element is the offset time. For example, an entry of [1.0 0.1] would specify a 1.0 second sample time with a 0.1 second offset. If no offset is specified, the default is zero.

You can enter workspace variables when discretizing blocks in the s-domain. See “Discrete blocks (Enter parameters in s-domain)” on page 4-72.

Specify the Discretization Method

Specify the discretization method in the **Replace current selection with** field. The options are

- Discrete blocks (Enter parameters in s-domain)
Creates a discrete block whose parameters are retained from the corresponding continuous block.
- Discrete blocks (Enter parameters in z-domain)
Creates a discrete block whose parameters are “hard-coded” values placed directly into the block’s dialog.

- Configurable subsystem (Enter parameters in s-domain)
Create multiple discretization candidates using s-domain values for the current selection. A configurable subsystem can consist of one or more blocks.
- Configurable subsystem (Enter parameters in z-domain)
Create multiple discretization candidates in z-domain for the current selection. A configurable subsystem can consist of one or more blocks.

Discrete blocks (Enter parameters in s-domain). Creates a discrete block whose parameters are retained from the corresponding continuous block. The sample time and the discretization parameters are also on the block's parameter dialog.

The block is implemented as a masked discrete block that uses `c2d` to transform the continuous parameters to discrete parameters in the mask initialization code.

These blocks have the unique capability of reverting to continuous behavior if the sample time is changed to zero. Entering the sample time as a workspace variable ('Ts' , for example) allows for easy changeover from continuous to discrete and back again. See "Specify the Sample Time" on page 4-71.

Note Parameters are not tunable when **Inline parameters** is selected in the model's **Configuration Parameters** dialog box.

The figure below shows a continuous Transfer Function block next to a Transfer Function block that has been discretized in the s-domain. The **Block Parameters** dialog box for each block is shown below the block.

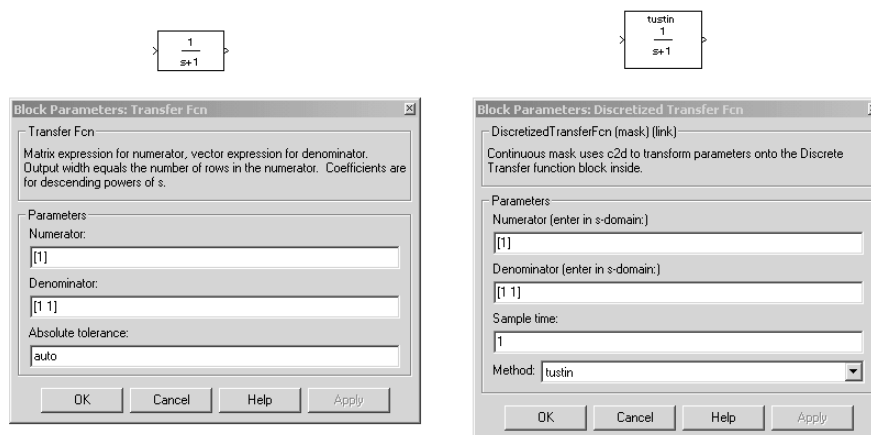

Discrete blocks (Enter parameters in z-domain). Creates a discrete block whose parameters are “hard-coded” values placed directly into the block’s dialog. The model discretizer uses the `c2d` function to obtain the discretized parameters, if needed.

For more help on the `c2d` function, type the following in the Command Window:

```
help c2d
```

The figure below shows a continuous Transfer Function block next to a Transfer Function block that has been discretized in the z-domain. The **Block Parameters** dialog box for each block is shown below the block.

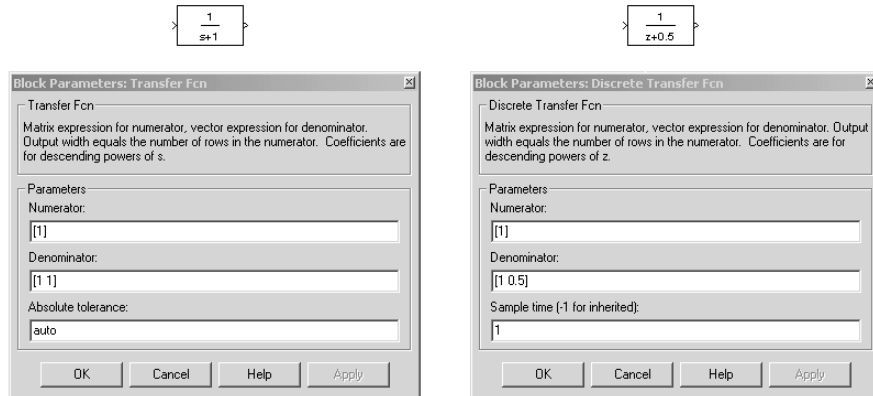

Note If you want to recover exactly the original continuous parameter values after the Model Discretization session, you should enter parameters in the s-domain.

Configurable subsystem (Enter parameters in s-domain). Create multiple discretization candidates using s-domain values for the current selection. A configurable subsystem can consist of one or more blocks.

The **Location for block in configurable subsystem** field becomes active when this option is selected. This option allows you to either create a new configurable subsystem or overwrite an existing one.

Note The current directory must be writable in order to save the library or libraries for the configurable subsystem option.

Configurable subsystem (Enter parameters in z-domain). Create multiple discretization candidates in z-domain for the current selection. A configurable subsystem can consist of one or more blocks.

The **Location for block in configurable subsystem** field becomes active when this option is selected. This option allows you to either create a new configurable subsystem or overwrite an existing one.

Note The current directory must be writable in order to save the library or libraries for the configurable subsystem option.

Configurable subsystems are stored in a library containing the discretization candidates and the original continuous block. The library will be named <model name>_disc_lib and it will be stored in the current directory. For example a library containing a configurable subsystem created from the f14 model will be named f14_disc_lib.

If multiple libraries are created from the same model, then the filenames will increment accordingly. For example, the second configurable subsystem library created from the f14 model will be named f14_disc_lib2.

You can open a configurable subsystem library by right-clicking on the subsystem in the Simulink model and selecting **Link options -> Go to library block** from the pop-up menu.

Discretize the Blocks

To discretize blocks that are linked to a library, you must either discretize the blocks in the library itself or disable the library links in the model window.

You can open the library from the Model Discretizer by selecting **Load model** from the **File** menu.

You can disable the library links by right-clicking on the block and selecting **Link options -> Disable link** from the pop-up menu.

There are two methods for discretizing blocks.

Select Blocks and Discretize.

- 1 Select a block or blocks in the Model Discretizer tree view pane.

To choose multiple blocks, press and hold the **Ctrl** button on the keyboard while selecting the blocks.

Note You must select blocks from the Model Discretizer tree view. Clicking on blocks in the Simulink editor does not select them for discretization.

- 2 Select **Discretize current block** from the **Discretize** menu if a single block is selected or select **Discretize selected blocks** from the **Discretize** menu if multiple blocks are selected.

You can also discretize the current block by clicking the Discretize button, shown below.



Store the Discretization Settings and Apply Them to Selected Blocks in the Model.

- 1 Enter the discretization settings for the current block.
- 2 Click **Store Settings**.

This adds the current block with its discretization settings to the group of preset blocks.

- 3 Repeat steps 1 and 2, as necessary.
- 4 Select **Discretize preset blocks** from the **Discretize** menu.

Deleting a Discretization Candidate from a Configurable Subsystem

You can delete a discretization candidate from a configurable subsystem by selecting it in the **Location for block in configurable subsystem** field and clicking the Delete button, shown below.



Undoing a Discretization

To undo a discretization, click the Undo discretization button, shown below.



Alternatively, you can select **Undo discretization** from the **Discretize** menu.

This operation undoes discretizations in the current selection and its children. For example, performing the undo operation on a subsystem will remove discretization from all blocks in all levels of the subsystem's hierarchy.

Viewing the Discretized Model

The Model Discretizer displays the model in a hierarchical tree view.

Viewing Discretized Blocks

The block's icon in the tree view becomes highlighted with a “z” when the block has been discretized. The figure below shows that the Aircraft Dynamics Model subsystem has been discretized into a configurable subsystem with three discretization candidates. The other blocks in this f14 model have not been discretized.

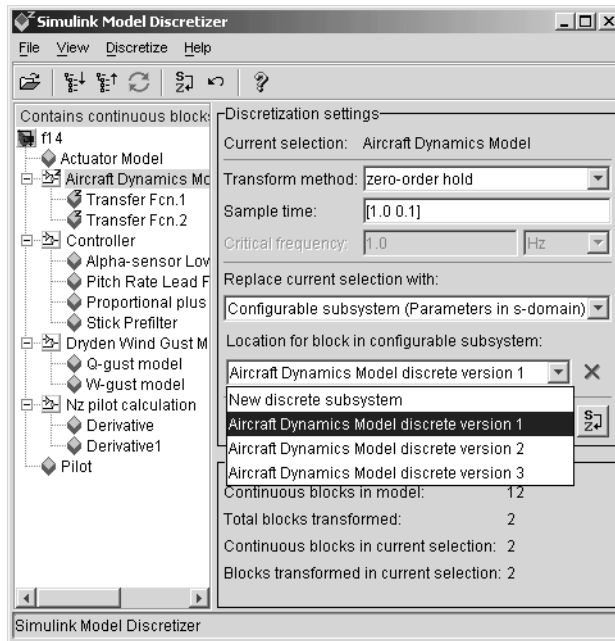

The following figure shows the Aircraft Dynamics Model subsystem of the f14 demo model after discretization into a configurable subsystem containing the original continuous model and three discretization candidates.

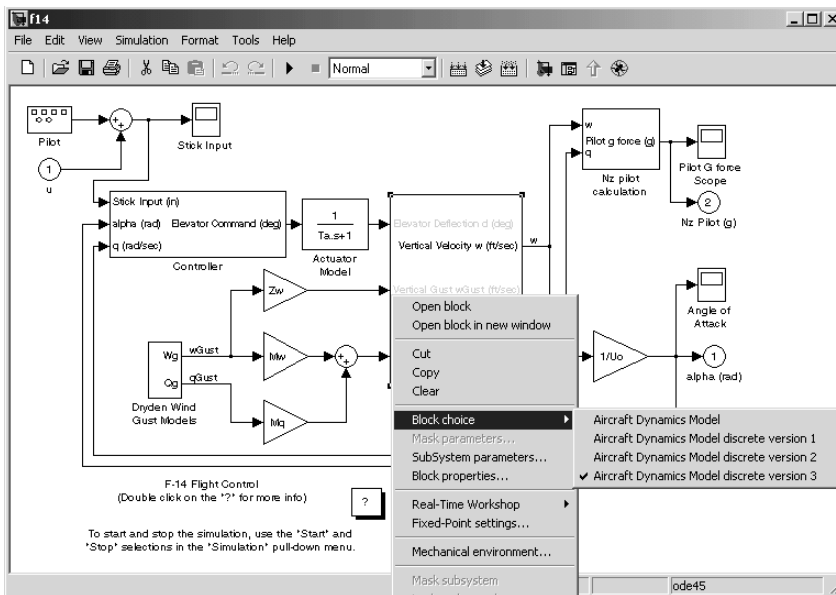

The following figure shows the library containing the Aircraft Dynamics Model configurable subsystem with the original continuous model and three discretization candidates.

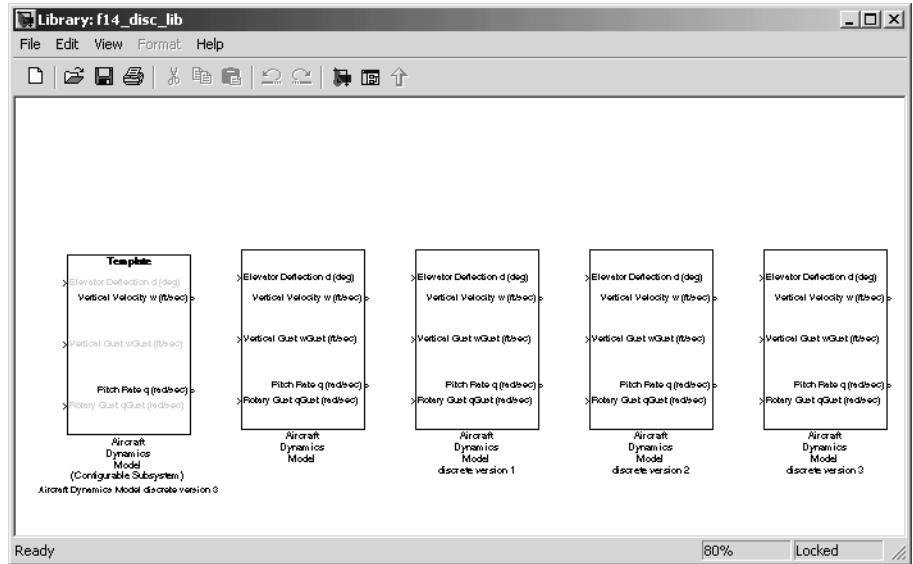

Refreshing Model Discretizer View of the Model

To refresh the Model Discretizer's tree view of the model when the model has been changed, click the Refresh button, shown below.



Alternatively, you can select **Refresh** from the **View** menu.

Discretizing Blocks from the Simulink Model

You can replace continuous blocks in a Simulink model with the equivalent blocks discretized in the s-domain using the Discretizing library.

The procedure below shows how to replace a continuous Transfer Fcn block in the Aircraft Dynamics Model subsystem of the f14 model with a discretized Transfer Fcn block from the Discretizing Library. The block is discretized in the s-domain with a zero-order hold transform method and a 2 second sample time.

- 1 Open the f14 model.
- 2 Open the Aircraft Dynamics Model subsystem in the f14 model.

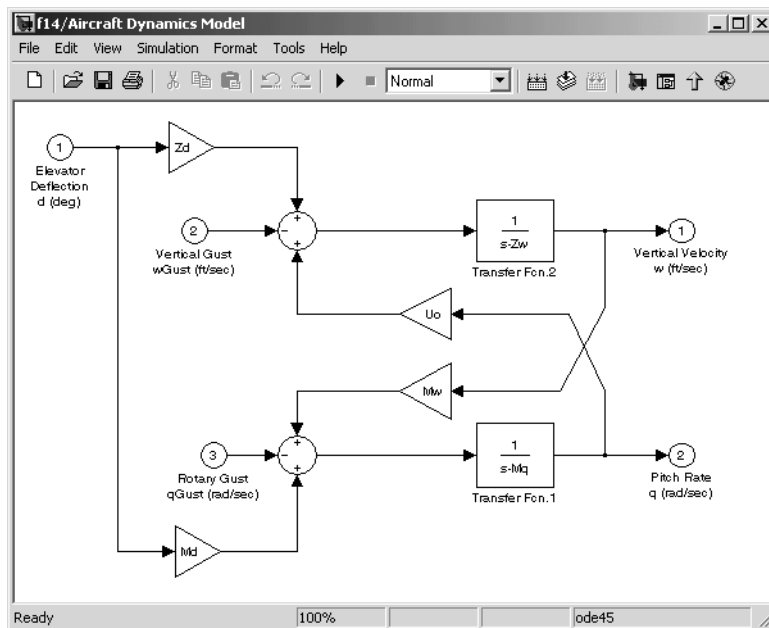

3 Open the Discretizing library window.

Enter discretizing at the MATLAB command prompt. The **Library: discretizing** window opens. This library contains s-domain discretized blocks.

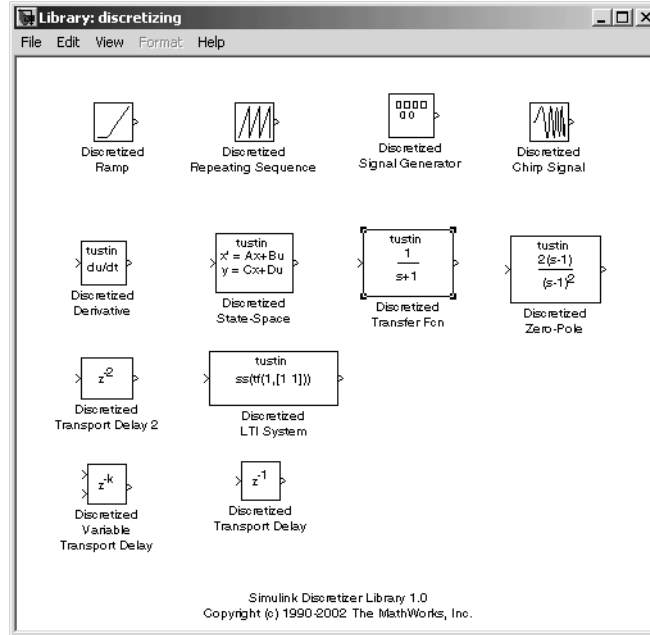

4 Add the Discretized Transfer Fcn block to the **f14/Aircraft Dynamics Model** window.

- a Click the Discretized Transfer Fcn block in **Library: discretizing** window.
- b Drag it into the **f14/Aircraft Dynamics Model** window.

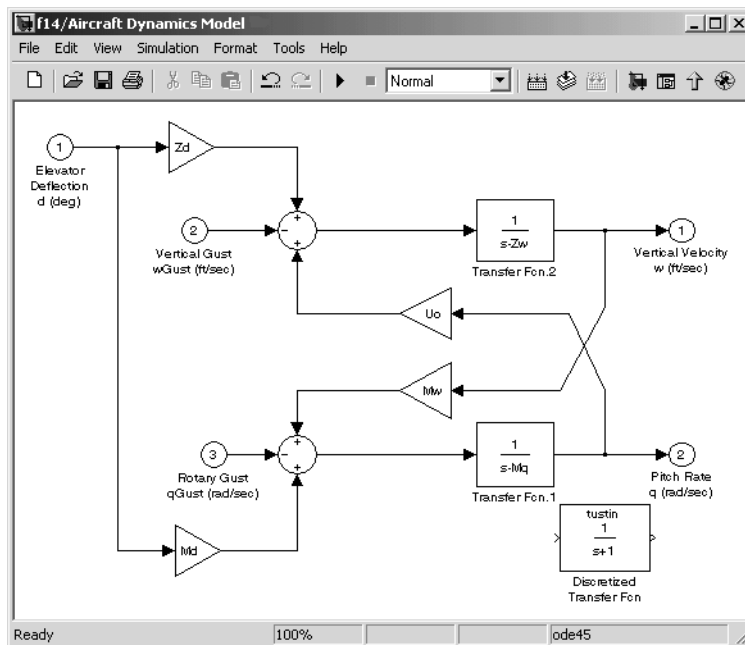

- 5 Open the parameter dialog box for the Transfer Fcn.1 block.

Double-click the Transfer Fcn.1 block in the **f14/Aircraft Dynamics Model** window. The **Block Parameters: Transfer Fcn.1** dialog box opens.

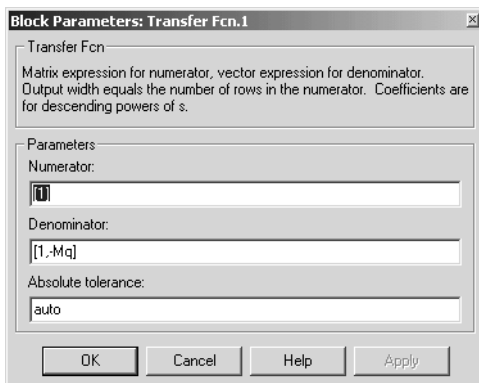

- 6 Open the parameter dialog box for the Discretized Transfer Fcn block.

Double-click the Discretized Transfer Fcn block in the **f14/Aircraft Dynamics Model** window. The **Block Parameters: Discretized Transfer Fcn** dialog box opens.

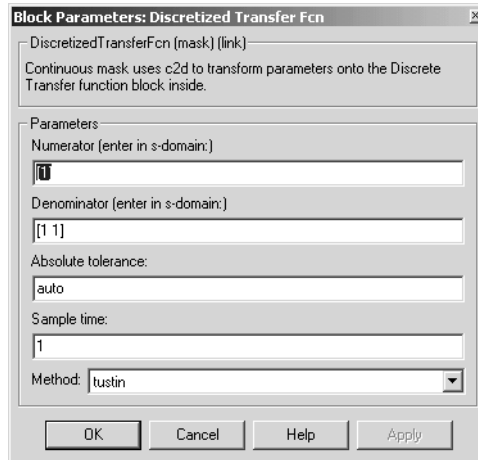

Copy the parameter information from the Transfer Fcn.1 block's dialog box to the Discretized Transfer Fcn block's dialog box.

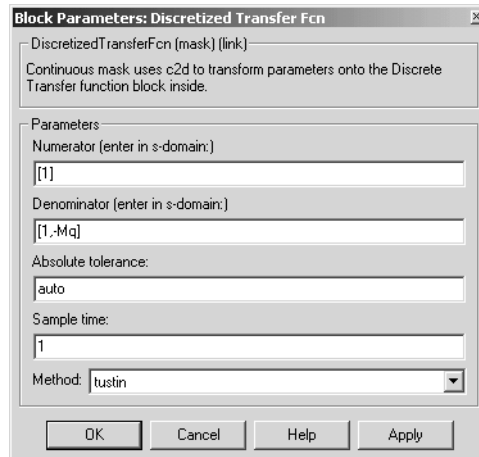

- 7 Enter 2 in the **Sample time** field.
- 8 Select **zoh** from the **Method** drop-down list.

The parameter dialog box for the Discretized Transfer Fcn. now looks like this.

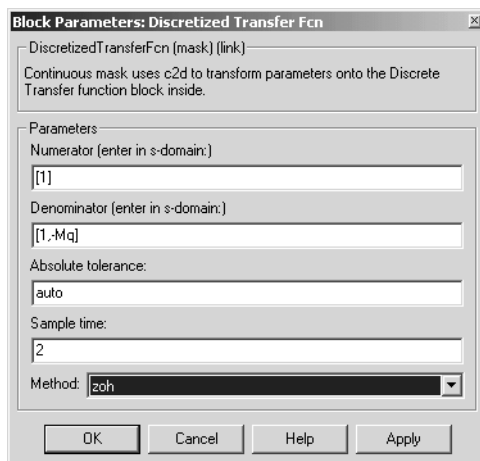

9 Click OK.

The f14/Aircraft Dynamics Model window now looks like this.

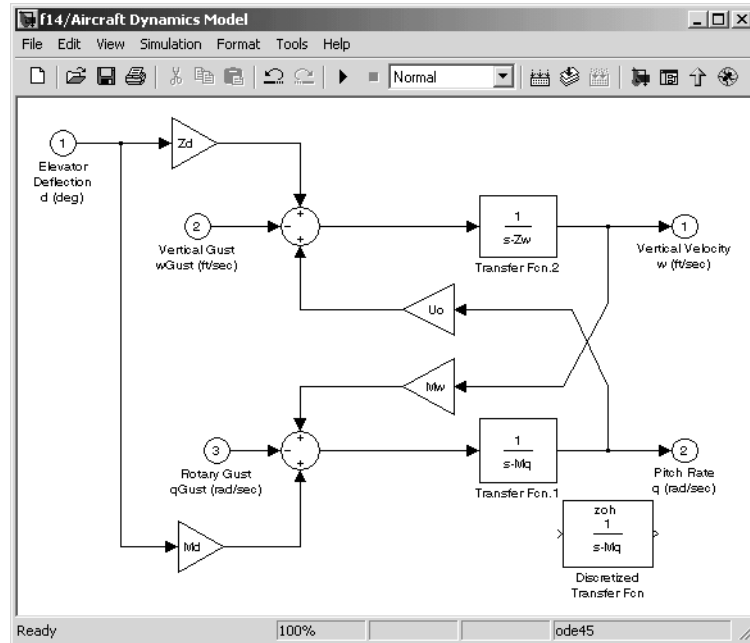

10 Delete the original Transfer Fcn.1 block.

- a** Click the Transfer Fcn.1 block.
- b** Press the **Delete** key. The **f14/Aircraft Dynamics Model** window now looks like this.

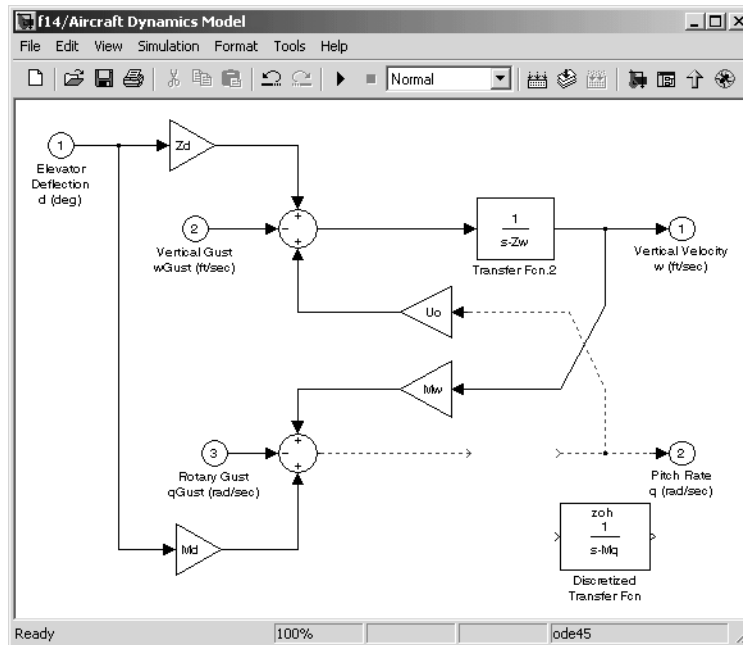

11 Add the Discretized Transfer Fcn block to the model.

- a Click the Discretized Transfer Fcn block.
- b Drag the Discretized Transfer Fcn block into position to complete the model. The **f14/Aircraft Dynamics Model** window now looks like this.

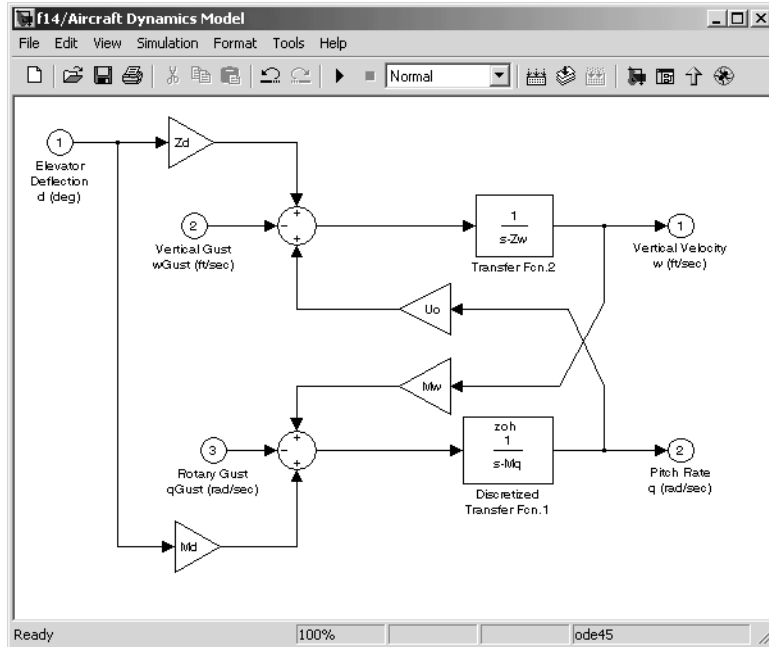

Discretizing a Model from the MATLAB Command Window

Use the `sldiscmdl` function to discretize Simulink models from the MATLAB Command Window. You can specify the transform method, the sample time, and the discretization method with the `sldiscmdl` function.

For example, the following command discretizes the `f14` model in the s-domain with a 1 second sample time using a zero-order hold transform method.

```
sldiscmdl('f14',1.0,'zoh')
```

For more information on the `sldiscmdl` function, see the reference pages in Simulink Model Construction Commands.

Using Callback Routines

You can define MATLAB expressions that execute when the block diagram or a block is acted upon in a particular way. These expressions, called *callback routines*, are associated with block, port, or model parameters. For example, the callback associated with a block's `OpenFcn` parameter is executed when the model user double-clicks on that block's name or the path changes.

Tracing Callbacks

Callback tracing allows you to determine the callbacks Simulink invokes and in what order Simulink invokes them when you open or simulate a model. To enable callback tracing, select the **Callback tracing** option on the Simulink **Preferences** dialog box (see “Setting Simulink Preferences” on page 1-18) or execute `set_param(0, 'CallbackTracing', 'on')`. This option causes Simulink to list callbacks in the MATLAB Command Window as they are invoked.

Creating Model Callback Functions

You can create model callback functions interactively or programmatically. Use the **Callbacks** pane of the model's **Model Properties** dialog box (see “Callbacks Pane” on page 4-106) to create model callbacks interactively. To create a callback programmatically, use the `set_param` command to assign a MATLAB expression that implements the function to the model parameter corresponding to the callback (see “Model Callback Parameters” on page 4-91).

For example, this command evaluates the variable `testvar` when the user double-clicks the Test block in `mymodel`.

```
set_param('mymodel/Test', 'OpenFcn', testvar)
```

You can examine the `clutch` system (`clutch.mdl`) for routines associated with many model callbacks.

Model Callback Parameters

The following table lists the model parameters used to specify model callback routines and indicates when the corresponding callback routines are executed.

Parameter	When Executed
CloseFcn	Before the block diagram is closed.
PostLoadFcn	After the model is loaded. Defining a callback routine for this parameter might be useful for generating an interface that requires that the model has already been loaded.
InitFcn	Called at start of model simulation.
PostSaveFcn	After the model is saved.
PreLoadFcn	Before the model is loaded. Defining a callback routine for this parameter might be useful for loading variables used by the model.
PreSaveFcn	Before the model is saved.
StartFcn	Before the simulation starts.
StopFcn	After the simulation stops. Output is written to workspace variables and files before the StopFcn is executed.

Note Beware of adverse interactions between callback functions of models referenced by other models. For example, suppose that model A references model B and that model A's OpenFcn creates variables in the MATLAB workspace and model B's CloseFcn clears the MATLAB workspace. Now suppose that simulating model A requires rebuilding model B. Rebuilding B entails opening and closing model B and hence invoking model B's CloseFcn, which clears the MATLAB workspace, including the variables created by A's OpenFcn.

Creating Block Callback Functions

You can create model callback functions interactively or programmatically. Use the **Callbacks** pane of the model's **Block Properties** dialog box (see "Callbacks Pane" on page 5-11) to create model callbacks interactively. To create a callback programmatically, use the `set_param` command to assign a MATLAB expression that implements the function to the block parameter corresponding to the callback (see "Block Callback Parameters" on page 4-92).

Note A callback for a masked subsystem cannot directly reference the parameters of the masked subsystem (see "About Masks" on page 12-2). The reason? Simulink evaluates block callbacks in a model's base workspace whereas the mask parameters reside in the masked subsystem's private workspace. A block callback, however, can use `get_param` to obtain the value of a mask parameter, e.g., `get_param(gcf, 'gain')`, where `gain` is the name of a mask parameter of the current block.

Block Callback Parameters

This table lists the parameters for which you can define block callback routines, and indicates when those callback routines are executed. Routines that are executed before or after actions take place occur immediately before or after the action.

Parameter	When Executed
ClipboardFcn	When the block is copied or cut to the system clipboard.
CloseFcn	When the block is closed using the <code>close_system</code> command.
CopyFcn	After a block is copied. The callback is recursive for Subsystem blocks (that is, if you copy a Subsystem block that contains a block for which the <code>CopyFcn</code> parameter is defined, the routine is also executed). The routine is also executed if an <code>add_block</code> command is used to copy the block.

Parameter	When Executed
DeleteChildFcn	After a block is deleted from a subsystem.
DeleteFcn	Before a block is deleted, e.g., when the user deletes the block or closes the model containing the block. This callback is recursive for Subsystem blocks.
DestroyFcn	When the block has been destroyed.
InitFcn	Before the block diagram is compiled and before block parameters are evaluated.
LoadFcn	After the block diagram is loaded. This callback is recursive for Subsystem blocks.
ModelCloseFcn	Before the block diagram is closed. This callback is recursive for Subsystem blocks.
MoveFcn	When the block is moved or resized.
NameChangeFcn	After a block's name and/or path changes. When a Subsystem block's path is changed, it recursively calls this function for all blocks it contains after calling its own NameChangeFcn routine.
OpenFcn	When the block is opened. This parameter is generally used with Subsystem blocks. The routine is executed when you double-click the block or when an open_system command is called with the block as an argument. The OpenFcn parameter overrides the normal behavior associated with opening a block, which is to display the block's dialog box or to open the subsystem.
ParentCloseFcn	Before closing a subsystem containing the block or when the block is made part of a new subsystem using the new_system command (see new_system in the "Model Creation Commands" section of the Simulink online Help).

Parameter	When Executed
PreSaveFcn	Before the block diagram is saved. This callback is recursive for Subsystem blocks.
PostSaveFcn	After the block diagram is saved. This callback is recursive for Subsystem blocks.
StartFcn	After the block diagram is compiled and before the simulation starts. In the case of an S-Function block, StartFcn executes immediately before the first execution of the block's mdlProcessParameters function. See "S-Function Callback Methods" in <i>Writing S-Functions</i> for more information.
StopFcn	At any termination of the simulation. In the case of an S-Function block, StopFcn executes after the block's mdlTerminate function executes. See "S-Function Callback Methods" in <i>Writing S-Functions</i> for more information.
UndoDeleteFcn	When a block delete is undone.

Port Callback Parameters

Block input and output ports have a single callback parameter, `ConnectionCallback`. This parameter allows you to set callbacks on ports that are triggered every time the connectivity of those ports changes. Examples of connectivity changes include deletion of blocks connected to the port and deletion, disconnection, or connection of branches or lines to the port.

Use `get_param` to get the port handle of a port and `set_param` to set the callback on the port. For example, suppose the currently selected block has a single input port. The following code fragment sets `foo` as the connection callback on the input port.

```
phs = get_param(gcb, 'PortHandles');
set_param(phs.Inport, 'ConnectionCallback', 'foo');
```

The first argument of the callback function must be a port handle. The callback function can have other arguments (and a return value) as well. For example, the following is a valid callback function signature.

```
function foo(port, otherArg1, otherArg2)
```

Working with Model Workspaces

Simulink provides each model with its own workspace for storing variable values. The model workspace is similar to the base MATLAB workspace except that

- Variables in a model's workspace are visible only in the scope of the model.
If both the MATLAB workspace and a model workspace define a variable of the same name (and the variable does not appear in any intervening masked subsystem or referenced model workspaces), Simulink uses the value of the variable in the model workspace. A model's workspace effectively provides it with its own name space, allowing you to create variables for the model without risk of conflict with other models.
- When the model is loaded, the workspace is initialized from a data repository.
The data repository can be a MAT-file or data or M-code stored in the model file itself (see "Data source" on page 4-99 for more information).
- You can interactively reload and save the current data repository.
- The only kind of Simulink data object that a model workspace can contain is `Simulink.Parameter`.
- In general, parameter variables in a model workspace are not tunable.

However, you can declare variables in a model's workspace as model arguments. You can tune the arguments of a model referenced by another model in the base workspace of the parent model.

Note When resolving references to variables used in a referenced model, i.e., a model referenced by a Model block (see "Referencing Models" on page 4-53), Simulink resolves the referenced model's variables as if the parent model does not exist. For example, suppose a referenced model references a variable that is defined in both the parent model's workspace and in the MATLAB workspace but not in the referenced model's workspace. In this case, Simulink uses the variable defined in the MATLAB workspace.

Changing a Model Workspace

The procedure for modifying a workspace depends on the workspace's data source. See the following sections for more information.

- “Changing a Workspace Whose Source is the Model File” on page 4-97
- “Changing a Workspace Whose Source Is a MAT-File” on page 4-98
- “Changing a Workspace Whose Source Is M-Code” on page 4-98

Changing a Workspace Whose Source is the Model File

If a model workspace's data source is data stored in the model, you can use the Model Explorer (see “The Model Explorer” on page 9-2) or MATLAB commands to change the model's workspace.

For example, to create a variable in a model workspace, using the Model Explorer, first select the workspace in the Model Explorer's **Model Hierarchy** pane. Then select **MATLAB Variable** from the Model Explorer's **Add** menu or toolbar. You can similarly use the Add menu or the Model Explorer toolbar to add a `Simulink.Parameter` object to a model workspace.

To change the value of a model workspace variable, select the workspace, then select the variable in the Model Explorer's **Contents** pane and edit the value displayed in the **Contents** pane or in the Model Explorer's object **Dialog** pane. To delete a model workspace variable, select the variable in the **Contents** pane and select **Delete** from the Model Explorer's **Edit** menu or toolbar. To save the changes, save the model.

To use MATLAB commands to change a model workspace, first get the workspace for the currently selected model:

```
hws = get_param(bdroot, 'modelworkspace');
```

This command returns a handle to a `Simulink.ModelWorkspace` object whose properties specify the source of the data used to initialize the model workspace. Edit the properties to change the data source. Use the following methods to list, set, and clear variables, evaluate expressions in, and save and reload workspaces:

- `whos(hws)`
- `assignin(hws, 'varname', value)`
- `evalin(hws, 'expression')`
- `clear(hws)`

- `clear(hws, 'var1', 'var2', ...)`
- `save(hws)`
- `reload(hws)`

Note You can use dot notation to invoke these methods on a workspace object, i.e., `hws.assignin('varname', value)` is equivalent to `assignin(hws, 'varname', value)`.

The following example uses MATLAB commands to create, save, and load variables in the currently selected model's workspace.

```
a = get_param(bdroot, 'modelworkspace');
a.DataSource = 'MAT-File';
a.RelativePath = 'on';
a.FileName = 'params';
a.assignin(a, 'pitch', -10);
a.assignin('roll', 30);
a.assignin('yaw', -2);
a.save;
a.reload;
```

Changing a Workspace Whose Source Is a MAT-File

You cannot use the Model Explorer or model workspace commands to modify a model workspace whose source is a MAT-file. To change a model workspace whose source is a MAT-file, you must recreate the MAT-file and reload it. An easy way to do this is to use the model workspace's dialog box (see “Model Workspace Dialog Box” on page 4-99) to change the workspace's source temporarily to the model, make your changes, using the Model Explorer's object creation and editing controls, export the changes to the MAT-file, and then change the workspace's source back to the MAT-file.

Changing a Workspace Whose Source Is M-Code

Simulink does not allow you to use the Model Explorer's object creation and editing controls or model workspace commands to change a model workspace whose source is M-code. To change such a workspace, you must use the workspace's dialog box to edit the M-code and reinitialize the workspace (see “M-Code Source Controls” on page 4-101).

Model Workspace Dialog Box

The Model Workspace Dialog Box enables you to specify a model workspace's source and model reference arguments. To display the dialog box, select the model workspace in the Model Explorer's Model Hierarchy pane.

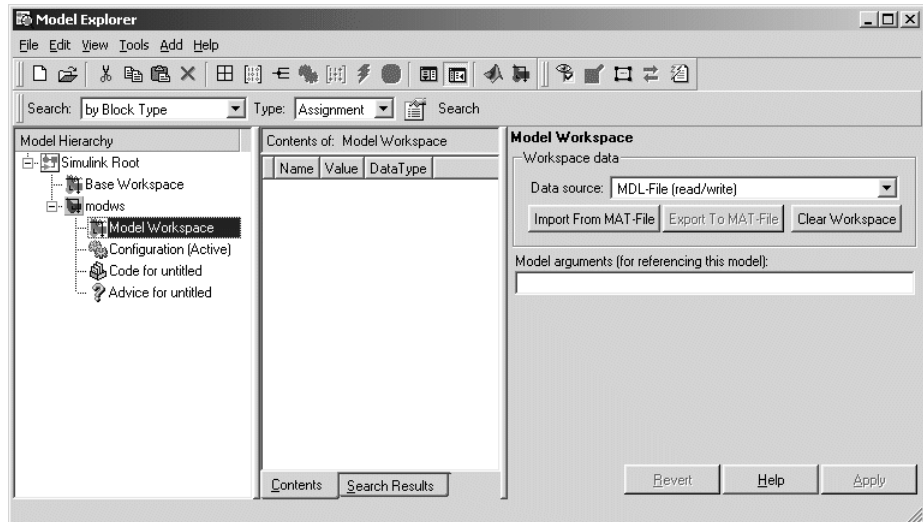

The dialog box contains the following controls.

Data source

Specifies the source of this workspace's data. The options are

- **Mdl -File**
Specifies that the data source is the model itself. Selecting this option causes additional controls to appear (see “MDL-File Source Controls” on page 4-100).
- **MAT -File**
Specifies that the data source is a MAT file. Selecting this option causes additional controls to appear (see “MAT-File Source Controls” on page 4-100).

- M-code

Specifies that the data source is M code stored in the model file. Selecting this option causes additional controls to appear (see “M-Code Source Controls” on page 4-101).

MDL-File Source Controls

Selecting Mdl-File as the **Data source** for a workspace causes the **Model Workspace** dialog box to display additional controls.

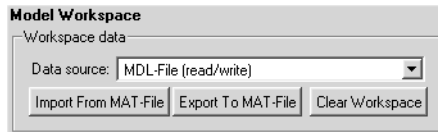

Import From MAT-File. This button lets you import data from a MAT-file. Selecting the button causes Simulink to display a file selection dialog box. Use the dialog box to select the MAT file that contains the data you want to import.

Export To MAT-File. This button lets you save the selected workspace as a MAT-file. Selecting the button causes Simulink to display a file selection dialog box. Use the dialog box to select the MAT file to contain the saved data.

Clear Workspace. This button clears all data from the selected workspace.

MAT-File Source Controls

Selecting Mdl-File as the **Data source** for a workspace causes the **Model Workspace** dialog box to display additional controls.

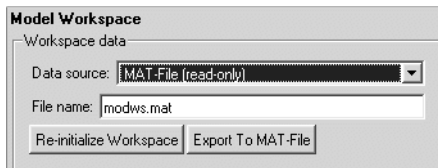

File name. File name or path name of the MAT file that is the data source for the selected workspace. If a file name, the name must reside on the MATLAB path.

Re-initialize Workspace. Clears the workspace and reloads it from the specified MAT file.

Export To MAT-File. This button lets you save the selected workspace as a MAT-file. Selecting the button causes Simulink to display a file selection dialog box. Use the dialog box to select the MAT file to contain the saved data.

M-Code Source Controls

Selecting M-Code as the **Data source** for a workspace causes the **Model Workspace** dialog box to display additional controls.

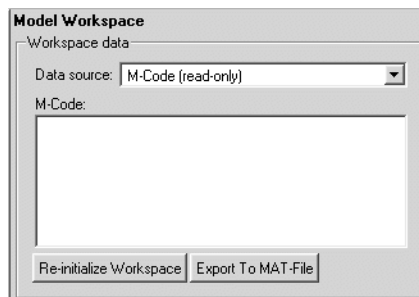

M-Code. Specifies M code that initializes the selected workspace in this field. To change the initialization code, edit this field and select the **Accept** button on the dialog box to confirm the changes and execute the modified code.

Re-initialize Workspace. Clears the workspace and executes the contents of the **M-Code** field.

Export To MAT-File. This button lets you save the selected workspace as a MAT-file. Selecting the button causes Simulink to display a file selection dialog box. Use the dialog box to select the MAT file to contain the saved data.

Model Arguments

This field allows you to specify arguments that can be passed to instances of this model referenced by another model. See “Using Model Arguments” on page 4-57 for more information.

Managing Model Versions

Simulink has features that help you to manage multiple versions of a model.

- As you edit a model, Simulink generates version control information about the model, including a version number, who created and last updated the model, and an optional change history. Simulink saves the automatically generated version control information with the model. See “Version Control Properties” on page 4-111 for more information.
- The Simulink **Model Parameters** dialog box lets you edit some of the version control information stored in the model and select various version control options (see “Model Properties Dialog Box” on page 4-105).
- The Simulink Model Info block lets you display version control information, including information maintained by an external version control system, as an annotation block in a model diagram.
- Simulink version control parameters let you access version control information from the MATLAB command line or an M-file.
- The **Source Control** submenu of the Simulink **File** menu allows you to check models into and out of your source control system. See “Interfacing with Source Control Systems” in the MATLAB documentation for more information.

Specifying the Current User

When you create or update a model, Simulink logs your name in the model for version control purposes. Simulink assumes that your name is specified by at least one of the following environment variables: `USER`, `USERNAME`, `LOGIN`, or `LOGNAME`. If your system does not define any of these variables, Simulink does not update the user name in the model.

UNIX systems define the `USER` environment variable and set its value to the name you use to log on to your system. Thus, if you are using a UNIX system, you do not have to do anything to enable Simulink to identify you as the current user. Windows systems, on the other hand, might define some or none of the “user name” environment variables that Simulink expects, depending on the version of Windows installed on your system and whether it is connected to a network. Use the MATLAB command `getenv` to determine which of the environment variables is defined. For example, enter

```
getenv('user')
```

at the MATLAB command line to determine whether the USER environment variable exists on your Windows system. If not, you must set it yourself. On Windows 98, set the value by entering the following line

```
set user=yourname
```

in your system's `autoexec.bat` file, where `yourname` is the name by which you want to be identified in a model file. Save the file `autoexec.bat` and reboot your computer for the changes to take effect.

Note The `autoexec.bat` file typically is found in the `c:\` directory on your system's hard disk.

On Windows NT and 2000, use the **Environment** variables pane of the **System Properties** dialog box to set the USER environment variable (if it is not already defined).

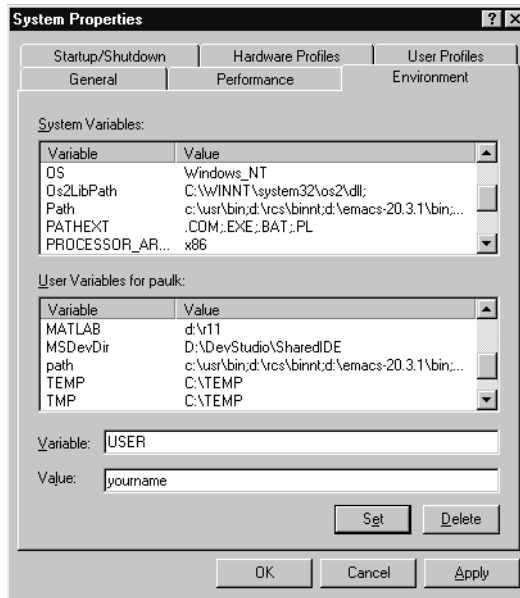

To display the **System Properties** dialog box, select **Start -> Settings -> Control Panel** to open the Control Panel. Double-click the **System** icon. To set the USER variable, enter USER in the **Variable** field and enter your login name in the **Value** field. Click **Set** to save the new environment variable. Then click **OK** to close the dialog box.

Model Properties Dialog Box

The **Model Properties** dialog box allows you to set various version control parameters and model callback functions. To display the dialog box, choose **Model Properties** from the Simulink **File** menu.

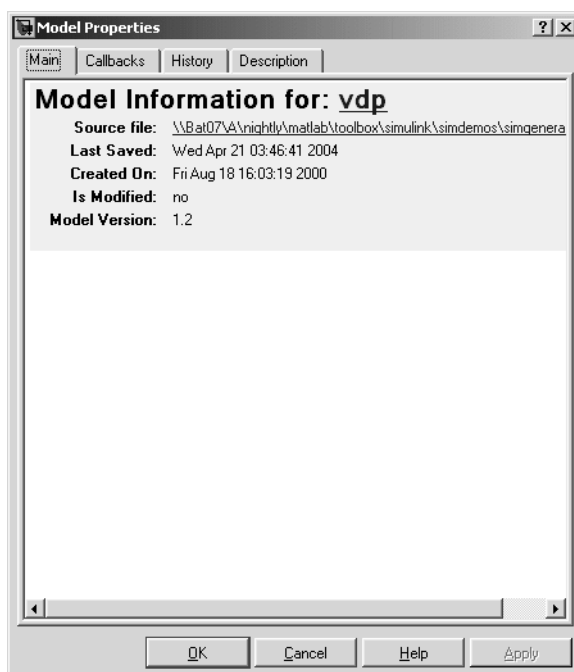

The dialog box includes the following panes.

Main Pane

The **Main** pane summarizes information about the current version of this model.

Callbacks Pane

The **Callbacks** pane lets you specify functions to be invoked by Simulink at specific points in the simulation of the model.

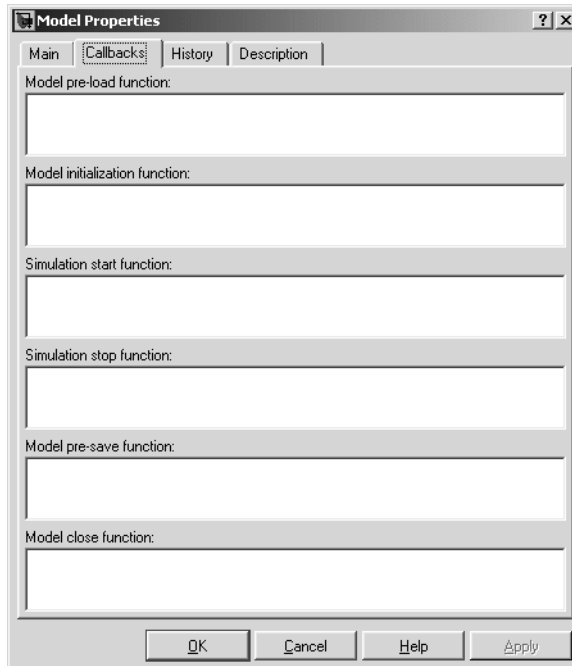

Enter the names of any callback functions you want to be invoked in the appropriate fields. See “Creating Model Callback Functions” on page 4-90 for information on the callback functions listed on this pane.

History Pane

The **History** pane allows you to enable, view, and edit this model's change history.

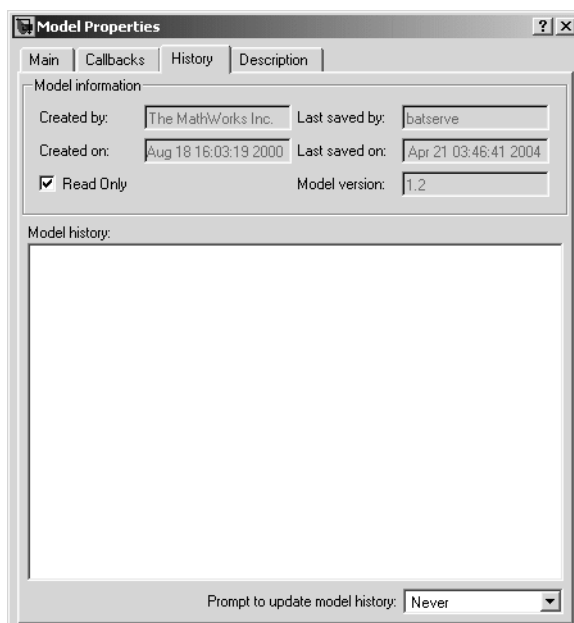

The **History** pane has two panels: the **Model information** panel and the **Model History** panel.

Version Information Panel

The contents of the **Version information** panel depend on the item selected in the list at the top of the panel. When **View current values** is selected, the panel shows the following fields.

Created by. Name of the person who created this model. Simulink sets this property to the value of the `USER` environment variable when you create the model. Edit this field to change the value.

Created on. Date and time this model was created.

Model version. Version number for this model. You cannot edit this field.

Last saved by. Name of the person who last saved this model. Simulink sets the value of this parameter to the value of the USER environment variable when you save a model.

Last saved date. Date that this model was last saved. Simulink sets the value of this parameter to the system date and time whenever you save a model.

Read Only. Deselecting this option shows the format strings for each of the fields listed when the option is selected.

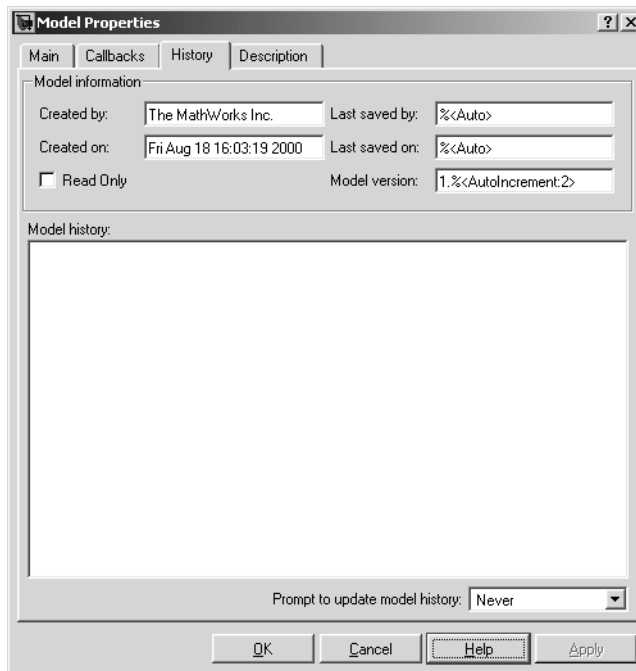

Model version. Enter a format string describing the format used to display the model version number in the **Model Properties** pane and in Model Info blocks. The value of this parameter can be any text string. The text string can include occurrences of the tag `%<AutoIncrement:#>` where # is an integer. Simulink replaces the tag with an integer when displaying the model's version number. For example, it displays the tag

```
1.%<AutoIncrement:2>
```

as

1.2

Simulink increments # by 1 when saving the model. For example, when you save the model,

```
1. %<1. %<AutoIncrement:2>
```

becomes

```
1. %<1. %<AutoIncrement:3>
```

and Simulink reports the model version number as 1.3.

Last saved by. Enter a format string describing the format used to display the **Last saved by** value in the **History** pane and the **ModifiedBy** entry in the history log and Model Info blocks. The value of this field can be any string. The string can include the tag `%<Auto>`. Simulink replaces occurrences of this tag with the current value of the `USER` environment variable.

Last saved on. Enter a format string describing the format used to display the **Last saved on** date in the **History** pane and the **ModifiedOn** entry in the history log and the in Model Info blocks. The value of this field can be any string. The string can contain the tag `%<Auto>`. Simulink replaces occurrences of this tag with the current date and time.

Model History Panel

The model history panel contains a scrollable text field and an option list. The text field displays the history for the model in a scrollable text field. To change the model history, edit the contents of this field. The option list allows you to enable or disable the Simulink model history feature. To enable the history feature, select *When saving model* from the **Prompt to update model history** list. This causes Simulink to prompt you to enter a comment when saving the model. Typically you would enter any changes that you have made to the model since the last time you saved it. Simulink stores this information in the model's change history log. See "Creating a Model Change History" on page 4-110 for more information. To disable the change history feature, select *Never* from the **Prompt to update model history** list.

Model Description Pane

This pane allows you to enter a description of the model.

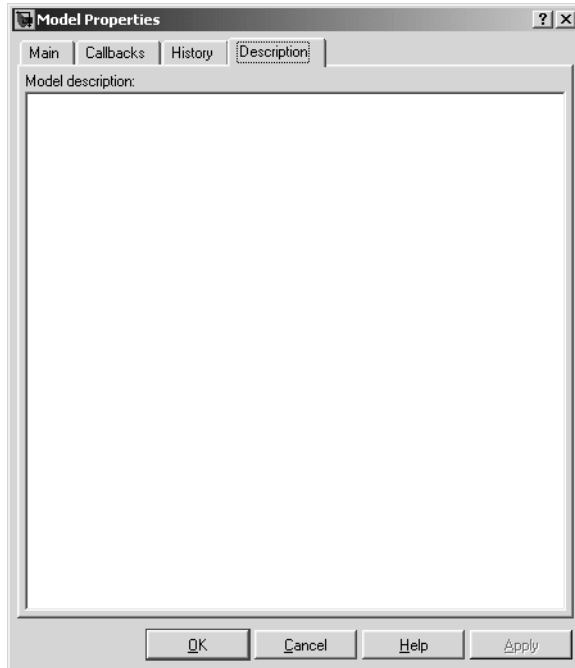

Creating a Model Change History

Simulink allows you to create and store a record of changes to a model in the model itself. Simulink compiles the history automatically from comments that you or other users enter when they save changes to a model.

Logging Changes

To start a change history, select **When saving model** from the **Prompt to update model history** list on the **History** pane on the Simulink **Model Properties** dialog box. The next time you save the model, Simulink displays a **Log Change** dialog box.

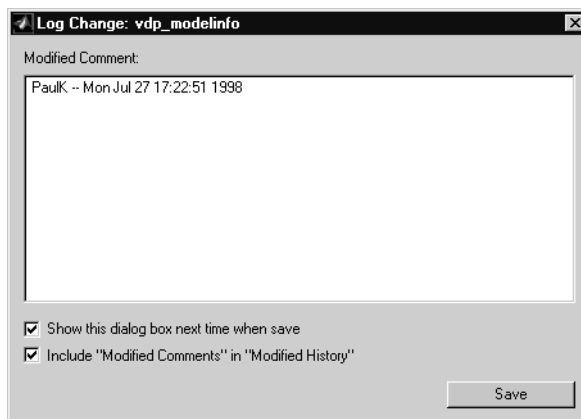

To add an item to the model's change history, enter the item in the **Modified Comments** edit field and click **Save**. If you do not want to enter an item for this session, clear the **Include "Modified Contents" in "Modified History"** option. To discontinue change logging, clear the **Show this dialog box next time when save** option.

Version Control Properties

Simulink stores version control information as model parameters in a model. You can access this information from the MATLAB command line or from an M-file, using the Simulink `get_param` command. The following table describes the model parameters used by Simulink to store version control information.

Property	Description
Created	Date created.
Creator	Name of the person who created this model.
ModifiedBy	Person who last modified this model.

Property	Description
ModifiedByFormat	Format of the ModifiedBy parameter. Value can be any string. The string can include the tag %<Auto>. Simulink replaces the tag with the current value of the USER environment variable.
ModifiedDate	Date modified.
ModifiedDateFormat	Format of the ModifiedDate parameter. Value can be any string. The string can include the tag %<Auto>. Simulink replaces the tag with the current date and time when saving the model.
ModifiedComment	Comment entered by user who last updated this model.
ModifiedHistory	History of changes to this model.
ModelVersion	Version number.
ModelVersionFormat	Format of model version number. Can be any string. The string can contain the tag %<AutoIncrement:#> where # is an integer. Simulink replaces the tag with # when displaying the version number. It increments # when saving the model.
Description	Description of model.
LastModificationDate	Date last modified.

Working with Blocks

This section explores the following block-related topics.

About Blocks (p. 5-2)	Explains the difference between virtual and nonvirtual blocks.
Editing Blocks (p. 5-4)	How to cut and paste blocks.
Setting Block Parameters (p. 5-7)	How to set parameters that determine a block's behavior.
Changing a Block's Appearance (p. 5-14)	How to change the size, orientation, color, and labeling of a block.
Displaying Block Outputs (p. 5-18)	How to display the values of block outputs on the block diagram during simulation.
Controlling and Displaying the Sorted Order (p. 5-20)	How to set a block's execution priority and display its execution order.
Lookup Table Editor (p. 5-22)	How to change the elements of lookup table blocks.
Working with Block Libraries (p. 5-29)	How to create and use block libraries.
Accessing Block Data During Simulation (p. 5-40)	How to use the Simulink runtime block API to access block data during a simulation.

About Blocks

Blocks are the elements from which Simulink models are built. You can model virtually any dynamic system by creating and interconnecting blocks in appropriate ways. This section discusses how to use blocks to build models of dynamic systems.

Block Data Tips

On Microsoft Windows, Simulink displays information about a block in a pop-up window when you allow the pointer to hover over the block in the diagram view. To disable this feature or control what information a data tip includes, select **Block data tips options** from the Simulink **View** menu.

Virtual Blocks

When creating models, you need to be aware that Simulink blocks fall into two basic categories: nonvirtual and virtual blocks. Nonvirtual blocks play an active role in the simulation of a system. If you add or remove a nonvirtual block, you change the model's behavior. Virtual blocks, by contrast, play no active role in the simulation; they help organize a model graphically. Some Simulink blocks are virtual in some circumstances and nonvirtual in others. Such blocks are called conditionally virtual blocks. The following table lists Simulink virtual and conditionally virtual blocks.

Block Name	Condition Under Which Block Is Virtual
Bus Selector	Always virtual.
Demux	Always virtual.
Enable	Virtual unless connected directly to an Outport block.
From	Always virtual.
Goto	Always virtual.
Goto Tag Visibility	Always virtual.
Ground	Always virtual.

Block Name	Condition Under Which Block Is Virtual
Inport	Virtual <i>unless</i> the block resides in a conditionally executed subsystem <i>and</i> has a direct connection to an outport block.
Mux	Always virtual.
Outport	Virtual when the block resides within any subsystem block (conditional or not), and does <i>not</i> reside in the root (top-level) Simulink window.
Selector	Virtual except in matrix mode.
Signal Specification	Always virtual.
Subsystem	Virtual unless the block is conditionally executed and/or the block's Treat as Atomic Unit option is selected.
Terminator	Always virtual.
Trigger	Virtual when the outport port is <i>not</i> present.

Editing Blocks

The Simulink Editor allows you to cut and paste blocks in and between models.

Copying and Moving Blocks from One Window to Another

As you build your model, you often copy blocks from Simulink block libraries or other libraries or models into your model window. To do this, follow these steps:

- 1 Open the appropriate block library or model window.
- 2 Drag the block to copy into the target model window. To drag a block, position the cursor over the block, then press and hold down the mouse button. Move the cursor into the target window, then release the mouse button.

You can also drag blocks from the Simulink Library Browser into a model window. See “Browsing Block Libraries” on page 5-36 for more information.

Note Simulink hides the names of Sum, Mux, Demux, Bus Creator, and Bus Selector blocks when you copy them from the Simulink block library to a model. This is done to avoid unnecessarily cluttering the model diagram. (The shapes of these blocks clearly indicate their respective functions.)

You can also copy blocks by using the **Copy** and **Paste** commands from the **Edit** menu:

- 1 Select the block you want to copy.
- 2 Choose **Copy** from the **Edit** menu.
- 3 Make the target model window the active window.
- 4 Choose **Paste** from the **Edit** menu.

Simulink assigns a name to each copied block. If it is the first block of its type in the model, its name is the same as its name in the source window. For

example, if you copy the Gain block from the Math library into your model window, the name of the new block is Gain. If your model already contains a block named Gain, Simulink adds a sequence number to the block name (for example, Gain1, Gain2). You can rename blocks; see “Manipulating Block Names” on page 5-15.

When you copy a block, the new block inherits all the original block’s parameter values.

Simulink uses an invisible five-pixel grid to simplify the alignment of blocks. All blocks within a model snap to a line on the grid. You can move a block slightly up, down, left, or right by selecting the block and pressing the arrow keys.

You can display the grid in the model window by typing the following command in the MATLAB window.

```
set_param('<model name>', 'showgrid', 'on')
```

To change the grid spacing, enter

```
set_param('<model name>', 'gridspacing', <number of pixels>)
```

For example, to change the grid spacing to 20 pixels, enter

```
set_param('<model name>', 'gridspacing', 20)
```

For either of the above commands, you can also select the model, then enter `gcs` instead of `<model name>`.

You can copy or move blocks to compatible applications (such as word processing programs) using the **Copy**, **Cut**, and **Paste** commands. These commands copy only the graphic representation of the blocks, not their parameters.

Moving blocks from one window to another is similar to copying blocks, except that you hold down the **Shift** key while you select the blocks.

You can use the **Undo** command from the **Edit** menu to remove an added block.

Moving Blocks in a Model

To move a single block from one place to another in a model window, drag the block to a new location. Simulink automatically repositions lines connected to the moved block.

To move more than one block, including connecting lines:

- 1 Select the blocks and lines. If you need information about how to select more than one block, see “Selecting More Than One Object” on page 4-3.
- 2 Drag the objects to their new location and release the mouse button.

Copying Blocks in a Model

You can copy blocks in a model as follows. While holding down the **Ctrl** key, select the block with the left mouse button, then drag it to a new location. You can also do this by dragging the block using the right mouse button. Duplicated blocks have the same parameter values as the original blocks. Sequence numbers are added to the new block names.

Deleting Blocks

To delete one or more blocks, select the blocks to be deleted and press the **Delete** or **Backspace** key. You can also choose **Clear** or **Cut** from the **Edit** menu. The **Cut** command writes the blocks into the clipboard, which enables you to paste them into a model. Using the **Delete** or **Backspace** key or the **Clear** command does not enable you to paste the block later.

You can use the **Undo** command from the **Edit** menu to replace a deleted block.

Setting Block Parameters

All Simulink blocks have a common set of parameters, called block properties, that you can set (see “Common Block Parameters” in the online Simulink Help). See “Block Properties Dialog Box” on page 5-9 for information on setting block properties. In addition, many blocks have one or more block-specific parameters that you can set (see “Block-Specific Parameters” in the online Simulink reference). By setting these parameters, you can customize the behavior of the block to meet the specific requirements of your model.

Setting Block-Specific Parameters

Every block that has block-specific parameters has a dialog box that you can use to view and set the parameters. You can display this dialog by selecting the block in the model window and choosing **BLOCK Parameters** from the model window’s **Edit** menu or from the model window’s context (right-click) menu, where **BLOCK** is the name of the block you selected, e.g., **Constant Parameters**. You can also display a block’s parameter dialog box by double-clicking its icon in the model or library window.

Note This holds true for all blocks with parameter dialog boxes except for the Subsystem block. You must use the model window’s **Edit** menu or context menu to display a Subsystem block’s parameter dialog.

For information on the parameter dialog of a specific block, see the block’s documentation in the “Simulink Blocks” in the online Simulink Help.

You can set any block parameter, using the Simulink `set_param` command. See `set_param` in the online Simulink Help for details.

You can use any MATLAB constant, variable, or expression that evaluates to an acceptable result when specifying the value of a parameter in a block parameter dialog or a `set_param` command. You can also use variables or expressions that evaluate to `Simulink.Parameter` data objects as parameters (see “Working with Data Objects” on page 7-10).

Tuning Parameters

Simulink lets you change the values of block parameters during simulation. You can use a block's parameter dialog box or the MATLAB Command Line to tune block parameters. To use the block's parameter dialog box, open the block's parameter dialog box, change the value displayed in the dialog box, and click the dialog box's **OK** or **Apply** button. You can use the `set_param` command to change the value of a variable at the MATLAB Command Line during simulation. Or, if the model uses a MATLAB workspace variable to specify the parameter's value, you can change the parameter's value by assigning a new value to the variable. In either case, you must update the model's block diagram for the change to take effect.

Inlining Parameters

You can declare some or all of a model's parameters as nontunable. Declaring a parameter as nontunable allows the Real-Time Workshop to include the parameter as a constant in code generated from the model, an optimization known as inlining a parameter. To inline all of a model's parameters, select the **Inline parameters** option on the **Optimization** pane of the model's active configuration set.

To inline some but not all of a model's parameters, you must first declare all of the parameters as inlined by selecting the **Inline parameters** option on the active set's **Optimization** pane. You must then specify the exceptions, using either the **Model Parameter Configuration** dialog box (see "Model Parameter Configuration Dialog Box" on page 10-47) or `Simulink.Parameter` objects.

Using Parameter Objects to Specify Parameter Tunability

To declare a parameter to be tunable even when the **Inline parameters** option is set, use an instance of `Simulink.Parameter` class to specify the parameter's value and set the parameter object's `RTWInfo.StorageClass` property to any value but 'Auto' (the default).

```
gain.RTWInfo.StorageClass = 'SimulinkGlobal';
```

If you set the `RTWInfo.StorageClass` property to any value other than `Auto`, you should not include the parameter in the tunable parameters table in the model's **Model Parameter Configuration** dialog box.

Note Simulink halts the simulation and displays an error message if it detects a conflict between the properties of a parameter as specified by a parameter object and the properties of the parameter as specified in the **Model Parameter Configuration** dialog box.

Block Properties Dialog Box

This dialog box lets you set a block's properties. To display this dialog, select the block in the model window and then select **Block Properties** from the **Edit** menu.

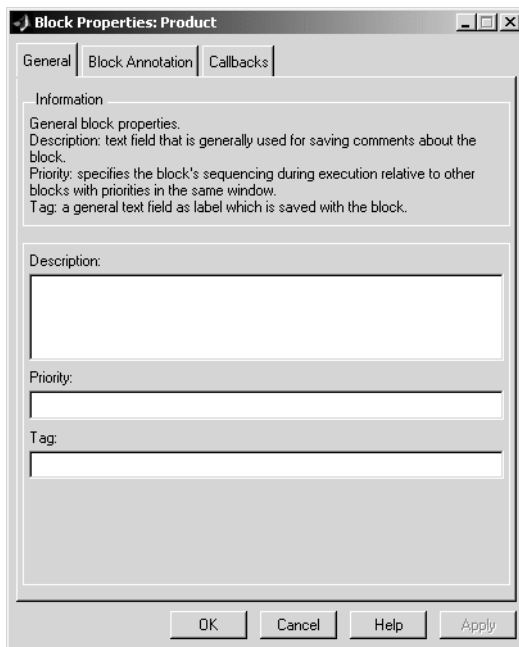

The dialog box contains the following tabbed panes.

General Pane

This pane allows you to set the following properties.

Description. Brief description of the block’s purpose.

Priority. Execution priority of this block relative to other blocks in the model. See “Assigning Block Priorities” on page 5-20 for more information.

Tag. Text that is assigned to the block’s Tag parameter and saved with the block in the model. You can use the tag to create your own block-specific label for a block.

Block Annotation Pane

The block annotation pane allows you to display the values of selected parameters of a block in an annotation that appears beneath the block’s icon.

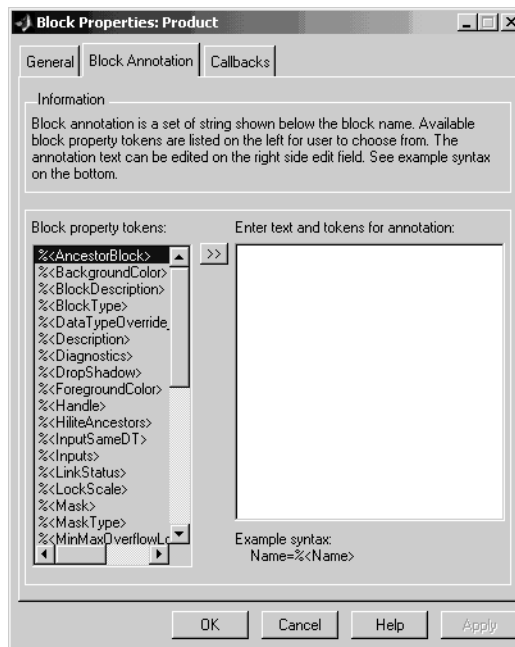

Enter the text of the annotation in the text field that appears on the right side of the pane. The text can include block property tokens, for example

```
%<Name>
Priority = %<priority>
```

of the form %<param> where param is the name of a parameter of the block. When displaying the annotation, Simulink replaces the tokens with the values of the corresponding parameters, e.g.,



The block property tag list on the left side of the pane lists all the tags that are valid for the currently selected block. To include one of the listed tags in the annotation, select the tag and then click the button between the tag list and the annotation field.

You can also create block annotations programmatically. See “Creating Block Annotations Programmatically” on page 5-12.

Callbacks Pane

The **Callbacks Pane** allows you to specify implementations for a block’s callbacks (see “Using Callback Routines” on page 4-90).

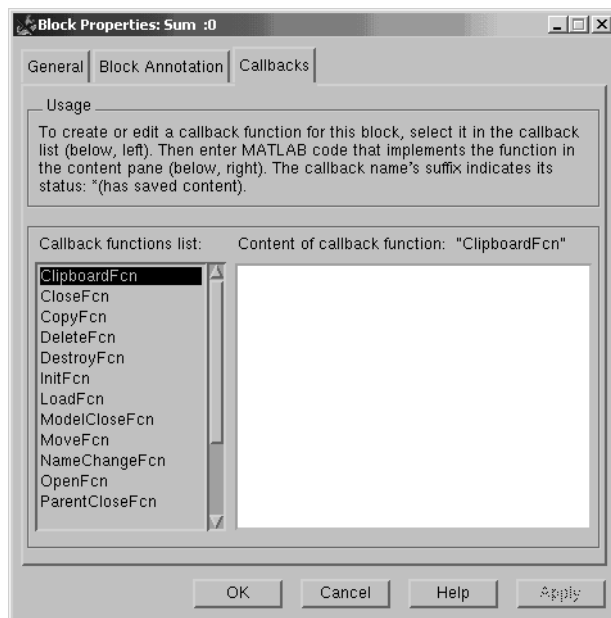

To specify an implementation for a callback, select the callback in the callback list on the left side of the pane. Then enter MATLAB commands that implement the callback in the right-hand field. Click **OK** or **Append** to save the change. Simulink appends an asterisk to the name of the saved callback to indicate that it has been implemented.

Creating Block Annotations Programmatically

You can use a block's `AttributesFormatString` parameter to display selected parameters of a block beneath the block as an “attributes format string,” i.e. a string that specifies values of the block's attributes (parameters). The “Model and Block Parameters” section in the online Simulink reference describes the parameters that a block can have. Use the Simulink `set_param` command to set this parameter to the desired attributes format string.

The attributes format string can be any text string that has embedded parameter names. An embedded parameter name is a parameter name preceded by `%<` and followed by `>`, for example, `%<priority>`. Simulink displays the attributes format string beneath the block's icon, replacing each parameter name with the corresponding parameter value. You can use line-feed characters (`\n`) to display each parameter on a separate line. For example, specifying the attributes format string

```
pri=%<priority>\ngain=%<Gain>
```

for a Gain block displays



If a parameter's value is not a string or an integer, Simulink displays N/S (not supported) for the parameter's value. If the parameter name is invalid, Simulink displays “???” as the parameter value.

State Properties Dialog Box

The **State Properties** dialog box allows you to specify code generation options for certain blocks with discrete states. To get help on using this dialog box, you must install the Real-Time Workshop documentation. See “Block States:

Storing and Interfacing” in the online documentation for Real-Time Workshop for more information.

Changing a Block's Appearance

The Simulink Editor allows you to change the size, orientation, color, and label location of a block in a block diagram.

Changing the Orientation of a Block

By default, signals flow through a block from left to right. Input ports are on the left, and output ports are on the right. You can change the orientation of a block by choosing one of these commands from the **Format** menu:

- The **Flip Block** command rotates the block 180 degrees.
- The **Rotate Block** command rotates a block clockwise 90 degrees.

The figure below shows how Simulink orders ports after changing the orientation of a block using the **Rotate Block** and **Flip Block** menu items. The text in the blocks shows their orientation.

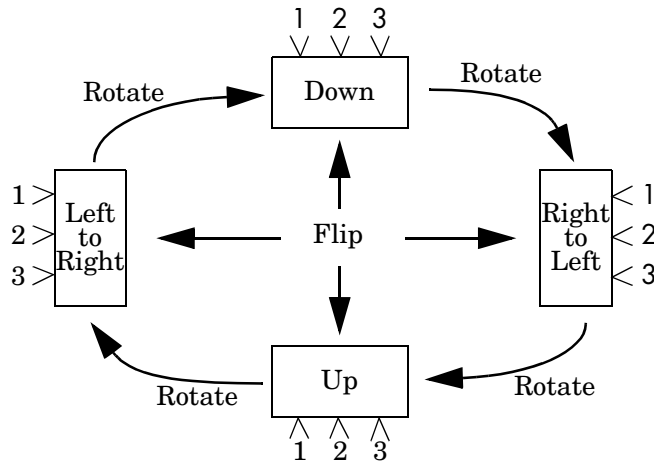

Resizing a Block

To change the size of a block, select it, then drag any of its selection handles. While you hold down the mouse button, a dotted rectangle shows the new block size. When you release the mouse button, the block is resized.

For example, the figure below shows a Signal Generator block being resized. The lower-right handle was selected and dragged to the cursor position. When the mouse button is released, the block takes its new size.

This figure shows a block being resized.

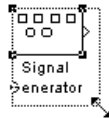

Displaying Parameters Beneath a Block

You can cause Simulink to display one or more of a block's parameters beneath the block. You specify the parameters to be displayed in the following ways:

- By entering an attributes format string in the **Attributes format string** field of the block's **Block Properties** dialog box (see "Block Properties Dialog Box" on page 5-9)
- By setting the value of the block's `AttributesFormatString` property to the format string, using `set_param`

Using Drop Shadows

You can add a drop shadow to a block by selecting the block, then choosing **Show Drop Shadow** from the **Format** menu. When you select a block with a drop shadow, the menu item changes to **Hide Drop Shadow**. The figure below shows a Subsystem block with a drop shadow.



Manipulating Block Names

All block names in a model must be unique and must contain at least one character. By default, block names appear below blocks whose ports are on the sides, and to the left of blocks whose ports are on the top and bottom, as the following figure shows.



Note Simulink commands interpret a forward slash, i.e., /, as a block path delimiter. For example, the path `vdp/Mu` designates a block named `Mu` in the model named `vdp`. Therefore, avoid using forward slashes (/) in block names to avoid causing Simulink to interpret the names as paths.

Changing Block Names

You can edit a block name in one of these ways:

- To replace the block name, click the block name, double-click or drag the cursor to select the entire name, then enter the new name.
- To insert characters, click between two characters to position the insertion point, then insert text.
- To replace characters, drag the mouse to select a range of text to replace, then enter the new text.

When you click the pointer anywhere else in the model or take any other action, the name is accepted or rejected. If you try to change the name of a block to a name that already exists or to a name with no characters, Simulink displays an error message.

You can modify the font used in a block name by selecting the block, then choosing the **Font** menu item from the **Format** menu. Select a font from the **Set Font** dialog box. This procedure also changes the font of any text that appears inside the block.

You can cancel edits to a block name by choosing **Undo** from the **Edit** menu.

Note If you change the name of a library block, all links to that block become unresolved.

Changing the Location of a Block Name

You can change the location of the name of a selected block in two ways:

- By dragging the block name to the opposite side of the block.
- By choosing the **Flip Name** command from the **Format** menu. This command changes the location of the block name to the opposite side of the block.

For more information about block orientation, see “Changing the Orientation of a Block” on page 5-14.

Changing Whether a Block Name Appears

To change whether the name of a selected block is displayed, choose a menu item from the **Format** menu:

- The **Hide Name** menu item hides a visible block name. When you select **Hide Name**, it changes to **Show Name** when that block is selected.
- The **Show Name** menu item shows a hidden block name.

Specifying a Block's Color

See “Specifying Block Diagram Colors” on page 4-5 for information on how to set the color of a block.

Displaying Block Outputs

Simulink can display block outputs as data tips on the block diagram while a simulation is running.

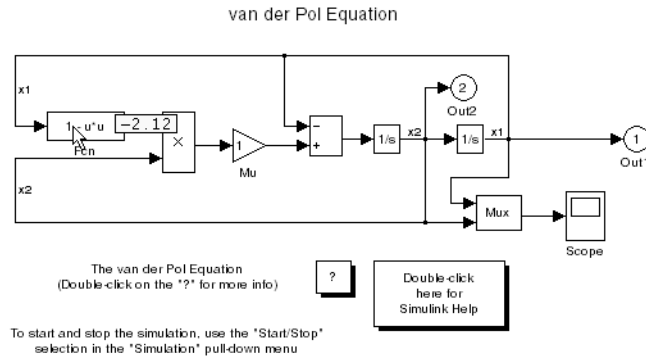

You can specify whether and when to display block outputs (see “Enabling Port Values Display” on page 5-18) and the size and format of the output displays and the rate at which Simulink updates them during a simulation (see “Port Values Display Options” on page 5-19).

Enabling Port Values Display

To turn display of port output values on or off, select **Port Values** from the model editor’s **View** menu. A menu of display options appears. Select one of the following display options from the menu:

- **Show none**
Turns port value displaying off.
- **Show when hovering**
Displays output port values for the block under the mouse cursor.
- **Toggle when selected**
Selecting a block displays its outputs. Reselecting the block turns the display off.

When using the Microsoft Windows version of Simulink, you can turn block output display when hovering on or off from the model editor's toolbar. To do this, select the block output display button on the toolbar.

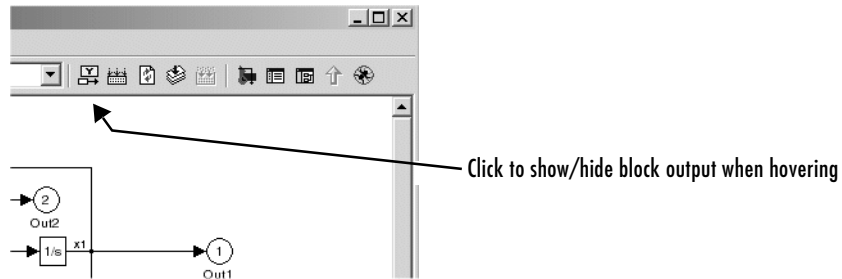

Port Values Display Options

To specify other display options, select **Port Values -> Options** from the model editor's **View** menu. The **Block Output Display Options** dialog box appears.

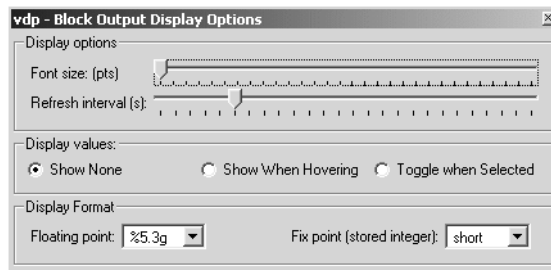

To increase the size of the output display text, move the **Font size** slider to the right. To increase the rate at which Simulink updates the displays, move the **Refresh interval slider** to the left.

Controlling and Displaying the Sorted Order

The sorted order is an ordering of the blocks in the model that Simulink uses as a starting point for determining the order in which to invoke the blocks' methods during simulation. Simulink allows you to display the sorted order for a model and to assign priorities to blocks that can influence where they appear in the sorted order.

Displaying the Sorted Order

To display the sorted order, select **Sorted order** from the Simulink **Format** menu. Selecting this option causes Simulink to display a notation in the top right corner of each block in a block diagram.

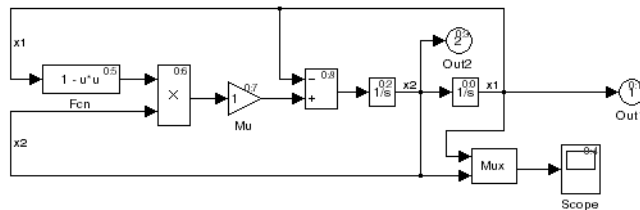

The notation for most blocks has the format **s:b**, where **s** specifies the index of the subsystem to whose execution context (see “Conditional Execution Behavior” on page 4-38) the block belongs and **b** specifies the block’s position in the sorted order for that execution context. The sorted order of a Function-Call Subsystem cannot be determined at compile time. Therefore, for these subsystems, Simulink uses either the notation **s:F**, if the system has one initiator, where **s** is the index of the subsystem that contains the initiator, or the notation **M**, if the subsystem has more than one initiator.

Assigning Block Priorities

You can assign priorities to nonvirtual blocks or virtual subsystem blocks in a model (see “Virtual Blocks” on page 5-2). Higher priority blocks appear before lower priority blocks in the sorted order, though not necessarily before blocks that have no assigned priority.

You can assign block priorities interactively or programmatically. To set priorities programmatically, use the command

```
set_param(b,'Priority','n')
```

where *b* is a block path and *n* is any valid integer. (Negative numbers and 0 are valid priority values.) The lower the number, the higher the priority; that is, 2 is higher priority than 3. To set a block's priority interactively, enter the priority in the **Priority** field of the block's **Block Properties** dialog box (see "Block Properties Dialog Box" on page 5-9).

Simulink honors the block priorities that you specify only if they are consistent with the Simulink block sorting algorithm. If Simulink is unable to honor a block priority, it displays a Block Priority Violation diagnostic message (see "The Diagnostics Pane" on page 10-48).

Lookup Table Editor

The Lookup Table Editor allows you to inspect and change the table elements of any lookup table (LUT) block in a model (see “Lookup Tables” in the online Simulink documentation), including custom LUT blocks that you have created, using the Simulink Mask Editor (see “Editing Custom LUT Blocks” on page 5-27). You can also use a block’s parameter dialog to edit its table. However, that requires you to open the subsystem containing the block first and then its parameter dialog box first. The LUT editor allows you to skip these steps. This section explains how to open and use the LUT editor to edit LUT blocks.

Note You cannot use the LUT Editor to change the dimensions of a lookup table. You must use the block’s parameter dialog box for this purpose.

To open the editor, select **Lookup table editor** from the Simulink **Tools** menu. The editor appears.

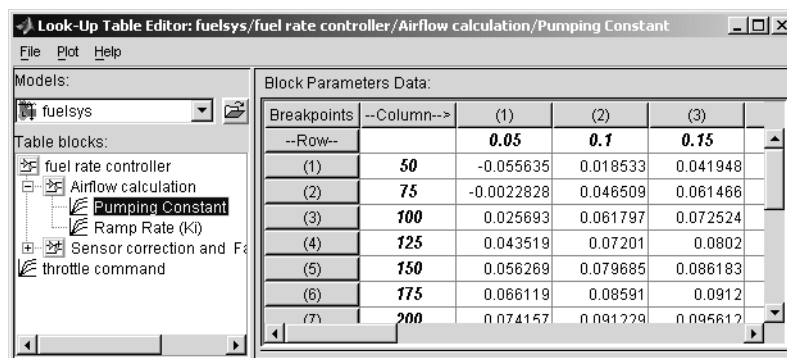

The editor contains two panes. The pane on the left is a LUT block browser. It allows you to browse and select LUT blocks in any open model (see “Browsing LUT Blocks” on page 5-23). The pane on the right allows you to edit the selected block’s lookup table (“Editing Table Values” on page 5-24).

Browsing LUT Blocks

The **Models** list in the upper left corner of the LUT Editor lists the names of all models open in the current MATLAB session. To browse any open model's LUT table blocks, select the model's name from the list. A tree-structured view of the selected model's LUT blocks appears in the **Table blocks** field beneath the **Models** list.

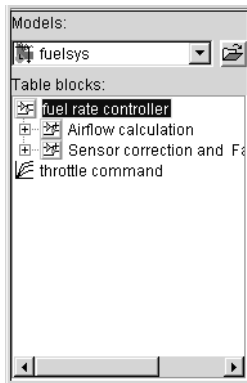

The tree view initially lists all the LUT blocks that reside at the model's root level. It also displays any subsystems that contain LUT blocks. Clicking the expand button (+) to the left of the subsystem's name expands the tree to show the LUT blocks in that subsystem. The expanded view also shows any subsystems in the expanded subsystem. You can continue expanding subsystem nodes in this manner to display LUT blocks at any level in the model hierarchy.

Clicking any LUT block in the LUT block tree view displays the block's lookup table in the right hand pane, allowing you to edit the table (see "Editing Table Values" on page 5-24).

Note If you want to browse the LUT blocks in a model that is not currently open, you can command the LUT Editor to open the model. To do this, select **Open** from the LUT Editor's **File** menu.

Editing Table Values

The **Block parameters data** table view of the LUT Editor allows you to edit the lookup table of the LUT block currently selected in the adjacent tree view.

Breakpoints	--Column-->	(1)	(2)	(3)	
--Row--		0.05	0.1	0.15	
(1)	50	-0.055635	0.018533	0.041948	
(2)	75	-0.0022828	0.046509	0.061466	
(3)	100	0.025693	0.061797	0.072524	
(4)	125	0.043519	0.07201	0.0802	
(5)	150	0.056269	0.079685	0.086183	
(6)	175	0.066119	0.08591	0.0912	
(7)	200	0.074157	0.091779	0.095612	

The table view displays the entire table if it is one- or two-dimensional or a two-dimensional slice of the table if the table has more than two dimensions (see “Displaying N-D Tables” on page 5-25). To change any of the displayed values, double-click the value. The LUT Editor replaces the value with an edit field containing the value. Edit the value, then press **Enter** or click outside the field to confirm the change.

The LUT Editor records your changes in a copy of the table that it maintains. To update the copy maintained by the LUT block itself, select **Update block data** from the LUT Editor’s **File** menu. To restore the LUT Editor’s copy to the values stored in the block, select **Reload block data** from the **File** menu.

Displaying N-D Tables

If the lookup table of the LUT block currently selected in the LUT Editor's tree view has more than two dimensions, the editor's table view displays a two-dimensional slice of the table.

Block Parameters Data:				
(1)	(2)	(3)	(4)	
2401	2421	2441	2461	
2402	2422	2442	2462	
2403	2423	2443	2463	
2404	2424	2444	2464	
2405	2425	2445	2465	
2406	2426	2446	2466	
2407	2427	2447	2467	
2408	2428	2448	2468	
2409	2429	2449	2469	

n-D Data Dimension Selector: viewing table data: (:,:,1,7)				
Dimension size	20	4	5	7
Select 2-D slice	:	:	1	7
Select row axis	<input type="radio"/>	<input type="radio"/>	<input type="radio"/>	<input type="radio"/>
Select column axis	<input type="radio"/>	<input checked="" type="radio"/>	<input type="radio"/>	<input type="radio"/>

The **n-D Data Dimension Selector** beneath the table specifies which slice currently appears and allows you to select another slice. The selector consists of a 4-by-N array of controls where N is the number of dimensions in the lookup table. Each column corresponds to a dimension of the lookup table. The first column corresponds to the first dimension of the table, the second column to the second dimension of the table, and so on. The top row of the selector array displays the size of each dimension. The remaining rows specify which dimensions of the table correspond to the row and column axes of the slice and the indices that select the slice from the remaining dimensions.

To select another slice of the table, click the **Select row axis** and **Select column axis** radio buttons in the columns that correspond to the dimensions that you want to view. Then select the indexes of the slice from the pop-up index lists in the remaining columns.

For example, the following selector displays slice (:, : ,1,7) of a 4-D table.

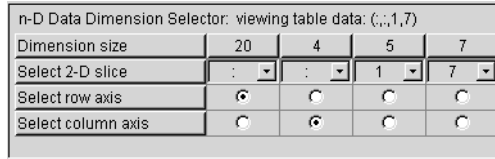

Plotting LUT Tables

Select **Linear** or **Mesh** from the **Plot** menu of the LUT Editor to display a linear or mesh plot of the table or table slice currently displayed in the editor's table view.

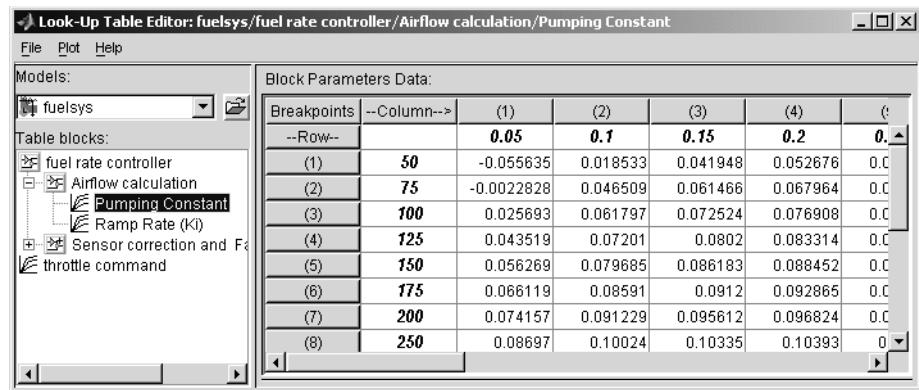

Linear

Mesh

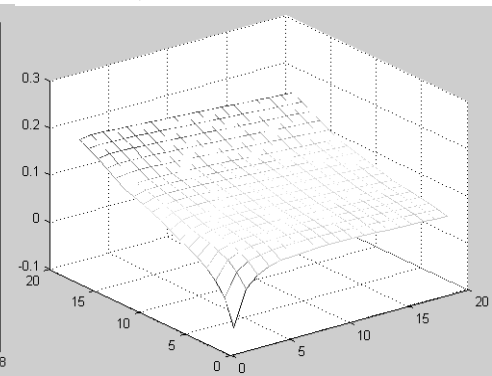
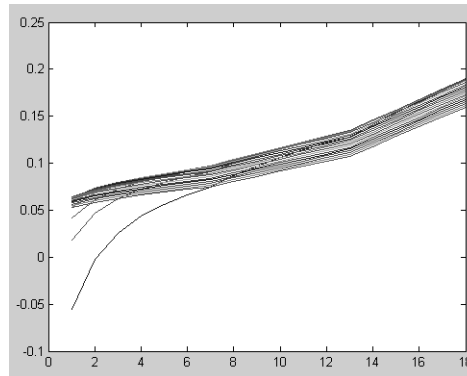

Editing Custom LUT Blocks

You can use the LUT Editor to edit custom lookup table blocks that you or others have created. To do this, you must first configure the LUT Editor to recognize the custom LUT blocks in your model. Once you have configured the LUT Editor to recognize the custom blocks, you can edit them as if they were standard blocks.

To configure the LUT editor to recognize custom LUT blocks, select **Configure** from the editor's **File** menu. The **Look-Up Table Blocks Type Configuration** dialog box appears.

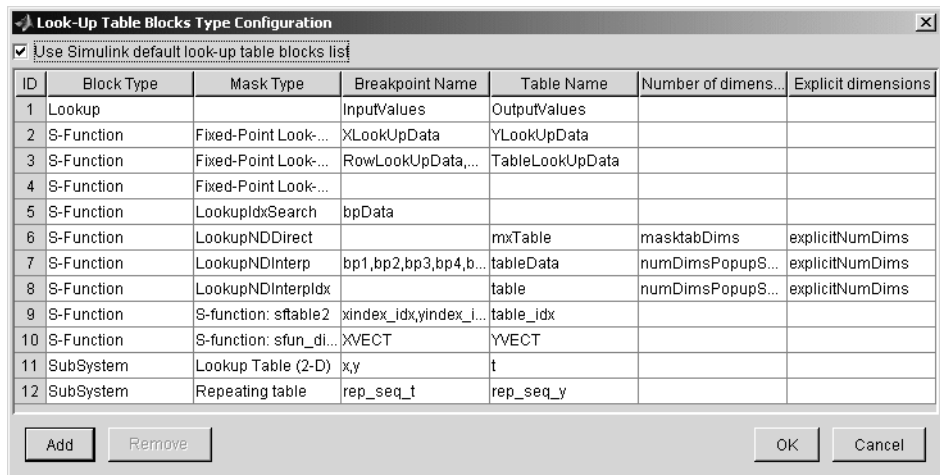

By default the dialog box displays a table of the types of LUT blocks that the LUT Editor currently recognizes. By default these are the standard Simulink LUT blocks. Each row of the table displays key attributes of a LUT block type.

Adding a Custom LUT Type

To add a custom block to the list of recognized types,

- 1 Select the **Add** button on the dialog box.

A new row appears at the bottom of the block type table.

- 2** Enter information for the custom block in the new row under the following headings.

Field Name	Description
Block Type	Block type of the custom LUT block. The block type is the value of the block's BlockType parameter.
Mask Type	Mask type in this field. The mask type is the value of the block's MaskType parameter.
Breakpoint Name	Names of the custom LUT block's parameters that store its breakpoints.
Table Name	Name of the block parameter that stores the custom block's lookup table.
Number of dimensions	Leave empty.
Explicit Dimensions	Leave empty.

- 3** Select **OK**.

Removing Custom LUT Types

To remove a custom LUT type from the list of types recognized by the LUT Editor, select the custom type's entry in the table in the **Look-Up Table Blocks Type Configuration** dialog box. Then select **Remove**. To remove all custom LUT types, check the check box labeled **Use Simulink default look-up table blocks list** at the top of the dialog box.

Working with Block Libraries

Libraries enable users to copy blocks into their models from external libraries and automatically update the copied blocks when the source blocks change. Using libraries allows users who develop their own block libraries, or who use those provided by others (such as blocksets), to ensure that their models automatically include the most recent versions of these blocks.

Terminology

It is important to understand the terminology used with this feature.

Library – A collection of library blocks. A library must be explicitly created using **New Library** from the **File** menu.

Library block – A block in a library.

Reference block – A copy of a library block.

Link – The connection between the reference block and its library block that allows Simulink to update the reference block when the library block changes.

Copy – The operation that creates a reference block from either a library block or another reference block.

This figure illustrates this terminology.

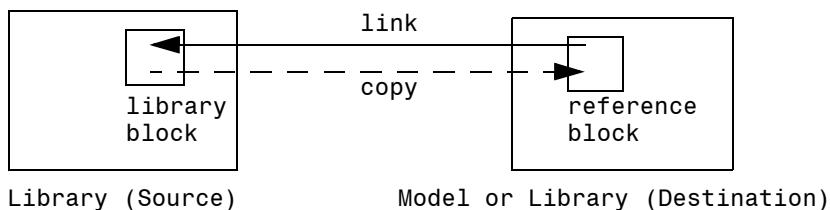

Simulink Block Library

Simulink comes with a library of standard blocks called the Simulink block library. See “Starting Simulink” on page 3-2 for information on displaying and using this library.

Creating a Library

To create a library, select **Library** from the **New** submenu of the **File** menu. Simulink displays a new window, labeled **Library: untitled**. If an untitled window already appears, a sequence number is appended.

You can create a library from the command line using this command:

```
new_system('newlib', 'Library')
```

This command creates a new library named 'newlib'. To display the library, use the `open_system` command. These commands are described in “Model Construction Commands” in the online Simulink reference.

The library must be named (saved) before you can copy blocks from it. See “Adding Libraries to the Library Browser” on page 5-38 for information on how to point the Library Browser to your new library.

Modifying a Library

When you open a library, it is automatically locked and you cannot modify its contents. To unlock the library, select **Unlock Library** from the **Edit** menu. Closing the library window locks the library.

Creating a Library Link

To create a link to a library block in a model, copy the block from the library to the model (see “Copying and Moving Blocks from One Window to Another” on page 5-4) or by dragging the block from the Library Browser (see “Browsing Block Libraries” on page 5-36) into the model window.

When you copy a library block into a model or another library, Simulink creates a link to the library block. The reference block is a copy of the library block. You can change the values of the reference block’s parameters but you cannot mask the block or, if it is masked, edit the mask. Also, you cannot set callback parameters for a reference block. If the link is to a subsystem, you can modify the contents of the reference subsystem (see “Modifying a Linked Subsystem” on page 5-31).

The library and reference blocks are linked *by name*; that is, the reference block is linked to the specific block and library whose names are in effect at the time the copy is made.

If Simulink is unable to find either the library block or the source library on your MATLAB path when it attempts to update the reference block, the link becomes *unresolved*. Simulink issues an error message and displays these blocks using red dashed lines. The error message is

```
Failed to find block "source-block-name"
in library "source-library-name"
referenced by block
"reference-block-path".
```

The unresolved reference block is displayed like this (colored red).

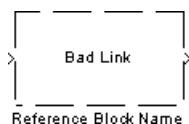

To fix a bad link, you must do one of the following:

- Delete the unlinked reference block and copy the library block back into your model.
- Add the directory that contains the required library to the MATLAB path and select **Update Diagram** from the **Edit** menu.
- Double-click the reference block. On the dialog box that appears, correct the pathname and click **Apply** or **Close**.

Disabling Library Links

Simulink allows you to disable linked blocks in a model. Simulink ignores disabled links when simulating a model. To disable a link, select the link, choose **Link options** from the model window's **Edit** or context menu, then choose **Disable link**. To restore a disabled link, choose **Restore link** from the **Link Options** menu.

Modifying a Linked Subsystem

Simulink allows you to modify subsystems that are library links. If your modifications alter the structure of the subsystem, you must disable the link from the reference block to the library block. If you attempt to modify the structure of a subsystem link, Simulink prompts you to disable the link. Examples of structural modifications include adding or deleting a block or line

or changing the number of ports on a block. Examples of nonstructural changes include changes to parameter values that do not affect the structure of the subsystem.

Propagating Link Modifications

Simulink allows a model to have active links with nonstructural but not structural changes. If you restore a link that has structural changes, Simulink prompts you to either propagate or discard the changes. If you choose to propagate the changes, Simulink updates the library block with the changes made in the reference block. If you choose to discard the changes, Simulink replaces the modified reference block with the original library block. In either case, the end result is that the reference block is an exact copy of the library block.

If you restore a link with nonstructural changes, Simulink enables the link without prompting you to propagate or discard the changes. If you want to propagate or discard the changes at a later time, select the reference block, choose **Link options** from the model window's **Edit** or context menu, then choose **Propagate/Discard changes**. If you want to view the nonstructural parameter differences between a reference block and its corresponding library block, choose **View changes** from the **Link options** menu.

Updating a Linked Block

Simulink updates out-of-date reference blocks in a model or library at these times:

- When the model or library is loaded
- When you select **Update Diagram** from the **Edit** menu or run the simulation
- When you query the `LinkStatus` parameter of a block, using the `get_param` command (see “Library Link Status” on page 5-34)
- When you use the `find_system` command

Updating Links to Reflect Block Path Changes

Library forwarding tables enable Simulink to update models to reflect changes in the names or locations of the library blocks that they reference. For example, suppose that you rename a block in a library. You can use a forwarding table

for that library to enable Simulink to update models that reference the block under its old name to reference it under its new name.

Simulink allows you to associate a forwarding table with any library. The forwarding table for a library specifies the old locations and new locations of blocks that have moved within the library or to another library. You associate a forwarding table with a library by setting its `ForwardingTable` parameter to a cell array of two-element cell arrays, each of which specifies the old and new path of a block that has moved. For example, the following command creates a forwarding table and assigns it to a library named `Lib1`.

```
set_param('Lib1', 'ForwardingTable', {'Lib1/A', 'Lib2/A'}  
{'Lib1/B', 'Lib1/C'});
```

The forwarding table specifies that block A has moved from `Lib1` to `Lib2`, and that block B is now named C. Suppose that you open a model that contains links to `Lib1/A` and `Lib1/B`. Simulink updates the link to `Lib1/A` to refer to `Lib2/A` and the link to `Lib1/B` to refer to `Lib1/C`. The changes become permanent when you subsequently save the model.

Breaking a Link to a Library Block

You can break the link between a reference block and its library block to cause the reference block to become a simple copy of the library block, unlinked to the library block. Changes to the library block no longer affect the block. Breaking links to library blocks may enable you to transport a model as a stand-alone model, without the libraries.

To break the link between a reference block and its library block, first disable the block. Then select the block and choose **Break Library Link** from the **Link options** menu. You can also break the link between a reference block and its library block from the command line by changing the value of the `LinkStatus` parameter to `'none'` using this command:

```
set_param('refblock', 'LinkStatus', 'none')
```

You can save a system and break all links between reference blocks and library blocks using this command:

```
save_system('sys', 'newname', 'BreakLinks')
```

Note Breaking library links in a model does not guarantee that you can run the model stand-alone, especially if the model includes blocks from third-party libraries or optional Simulink blocksets. It is possible that a library block invokes functions supplied with the library and hence can run only if the library is installed on the system running the model. Further, breaking a link can cause a model to fail when you install a new version of the library on a system. For example, suppose a block invokes a function that is supplied with the library. Now suppose that a new version of the library eliminates the function. Running a model with an unlinked copy of the block results in invocation of a now nonexistent function, causing the simulation to fail. To avoid such problems, you should generally avoid breaking links to third-party libraries and optional Simulink blocksets.

Finding the Library Block for a Reference Block

To find the source library and block linked to a reference block, select the reference block, then choose **Go To Library Link** from the **Link options** submenu of the model window's **Edit** or context menu. If the library is open, Simulink selects and highlights the library block and makes the source library the active window. If the library is not open, Simulink opens it and selects the library block.

Library Link Status

All blocks have a `LinkStatus` parameter that indicates whether the block is a reference block. The parameter can have these values.

Status	Description
none	Block is not a reference block.
resolved	Link is resolved.
unresolved	Link is unresolved.

Status	Description
implicit	Block resides in library block and is itself not a link to a library block. For example, suppose that A is a link to a subsystem in a library that contains a Gain block. Further, suppose that you open A and select the Gain block. Then, <code>get_param(gcb, 'LinkStatus')</code> returns <code>implicit</code> .
inactive	Link is disabled.
restore	Restores a broken link to a library block and discards any changes made to the local copy of the library block. For example, <code>set_param(gcb, 'LinkStatus', 'restore')</code> replaces the selected block with a link to a library block of the same type, discarding any changes in the local copy of the library block. Note that this parameter is a “write-only” parameter, i.e., it is usable only with <code>set_param</code> . You cannot use <code>get_param</code> to get it.
propagate	Restores a broken link to a library block and propagates any changes made to the local copy to the library.

Displaying Library Links

Simulink optionally displays an arrow in the bottom left corner of each block that represents a library link in a model.

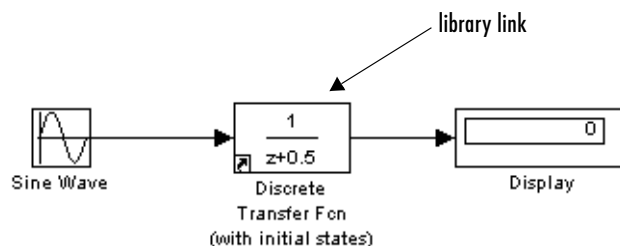

This arrow allows you to tell at a glance whether a block represents a link to a library block or a local instance of a block. To enable display of library links, select **Library Link Display** from the model window’s **Format** menu and then

select either **User** (displays only links to user libraries) or **All** (displays all links).

The color of the link arrow indicates the status of the link.

Color	Status
Black	Active link
Grey	Inactive link
Red	Active and modified

Getting Information About Library Blocks

Use the `libinfo` command to get information about reference blocks in a system

Browsing Block Libraries

The Library Browser lets you quickly locate and copy library blocks into a model. To display the Library Browser, click the **Library Browser** button in the toolbar of the MATLAB desktop or Simulink model window or enter `simulink` at the MATLAB command line.

Note The Library Browser is available only on Microsoft Windows platforms.

The Library Browser contains three panes.

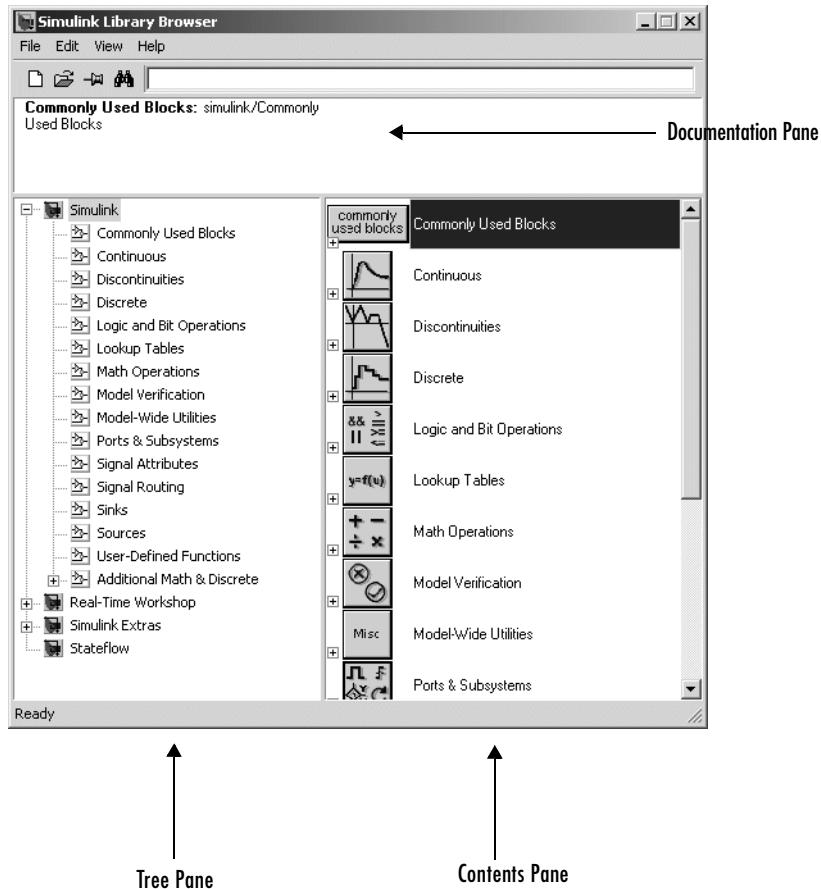

The tree pane displays all the block libraries installed on your system. The contents pane displays the blocks that reside in the library currently selected in the tree pane. The documentation pane displays documentation for the block selected in the contents pane.

You can locate blocks either by navigating the Library Browser's library tree or by using the Library Browser's search facility.

Navigating the Library Tree

The library tree displays a list of all the block libraries installed on the system. You can view or hide the contents of libraries by expanding or collapsing the tree using the mouse or keyboard. To expand/collapse the tree, click the +/- buttons next to library entries or select an entry and press the +/- or right/left arrow key on your keyboard. Use the up/down arrow keys to move up or down the tree.

Searching Libraries

To find a particular block, enter the block's name in the edit field next to the Library Browser's **Find** button, then click the **Find** button.

Opening a Library

To open a library, right-click the library's entry in the browser. Simulink displays an **Open Library** button. Select the **Open Library** button to open the library.

Creating and Opening Models

To create a model, select the **New** button on the Library Browser's toolbar. To open an existing model, select the **Open** button on the toolbar.

Copying Blocks

To copy a block from the Library Browser into a model, select the block in the browser, drag the selected block into the model window, and drop it where you want to create the copy.

Displaying Help on a Block

To display help on a block, right-click the block in the Library Browser and select the button that subsequently pops up.

Pinning the Library Browser

To keep the Library Browser above all other windows on your desktop, select the **PushPin** button on the browser's toolbar.

Adding Libraries to the Library Browser

If you want a library that you have created to appear in the Library Browser, you must create an `slblocks.m` file that describes the library in the directory

that contains it. The easiest way to create an `sblocks.m` file is to use an existing `sblocks.m` file as a template. You can find all existing `sblocks.m` files on your system by typing

```
which('sblocks.m', '-all')
```

at the MATLAB command prompt. Copy any of the displayed files to your library's directory. Then open the copy, edit it, following the instructions included in the file, and save the result. Finally, add your library's directory to the MATLAB path, if necessary. The next time you open the Library Browser, your library should appear among the libraries displayed in the browser.

Accessing Block Data During Simulation

Simulink provides an application programming interface (API) that enables programmatic access to block data, such as block inputs and outputs, parameters, states, and work vectors, while a simulation is running. You can use this interface to develop MATLAB programs capable of accessing block data while a simulation is running or to access the data from the MATLAB command line.

Note You can use this interface even when the model is paused or is running or stopped in the debugger.

To obtain the interface for a particular block, select the block and execute

```
br = get_param(gcf, 'RuntimeObject');
```

while the model containing the block is running. The syntax for accessing the value and attributes of the run-time data is:

```
get(br.InputPort(portIdx))
get(br.OutputPort(portIdx))
get(br.Dwork(dworkIdx))
get(br.ContStates(stateIdx))
get(br.RuntimePrm(prmIdx))
```

For example, to display the signal values at the first input port of a block when stopped in the debugger, you could type:

```
br = get_param(gcf, 'RuntimeObject');
br.InputPort(1).Data
```

The execution interface also supports an event-listener mechanism that allows you to listen for specific events during model simulation. In particular, you can request that Simulink throw events whenever a specific method (e.g., Outputs, Derivatives, or Update) of a given block is executed during a simulation. For instance, to determine when block a in model b executes its Outputs method, execute the following commands after you have started simulating the model:

```
br = get_param('b/a', 'RuntimeObject');
add_exec_event_listener('b/a', 'PostOutputs', 'disp(''here'')')
br.ExecutionEvents = 1;
```

Simulink now displays here after executing the output method of block b/a.

Note The final release of R14 will provide mechanisms for adding events before a simulation starts.

The `add_exec_event_listener` command supports the following events:

- PreOutputs
- PostOutputs
- PreUpdate
- PostUpdate
- PreDerivs
- PostDerivs

The listener can be any M callback you choose to register. The callback can also be a function handle for a function that accepts two input arguments:

- the block run-time object
i.e., the object returned by `get_param(gcb, 'RuntimeObject')`
- an event data object

Note You must install the events at the start of each simulation of a model, even in the same Simulink session.

Working with Signals

This section describes how to create and use Simulink signals.

Signal Basics (p. 6-2)	Explores key signal concepts, including signal data types, signal buses, virtual signals, signal dimensions, and signal properties.
Determining Output Signal Dimensions (p. 6-12)	Explains the rules that determine the dimensions of signals that blocks output.
The Signal & Scope Manager (p. 6-16)	How to use the Signal & Scope Manager to create signals and displays for viewing signals during simulation.
The Signal Selector (p. 6-23)	How to use the Signal Selector to connect signal generators to block inputs and block outputs to signal viewers.
Logging Signals (p. 6-27)	How to save signal values to the MATLAB workspace during simulation.
Signal Properties Dialog Box (p. 6-30)	How to use the Signal Properties dialog box to set signal properties.
Working with Test Points (p. 6-35)	How to ensure the visibility of a model's signals.
Displaying Signal Properties (p. 6-37)	How to display signal properties on a block diagram.
Working with Signal Groups (p. 6-41)	How to create and use interchangeable groups of signals, for example, to test a model.
Bus Editor (p. 6-55)	How to use the Bus Editor to create signal bus objects.

Signal Basics

This section provides an overview of Simulink signals and explains how to specify, display, and check the validity of signal connections.

About Signals

Simulink defines signals as the outputs of dynamic systems represented by blocks in a Simulink diagram and by the diagram itself. The lines in a block diagram represent mathematical relationships among the signals defined by the block diagram. For example, a line connecting the output of block A to the input of block B indicates that the signal output by B depends on the signal output by A.

Note It is tempting but misleading to think of Simulink signals as traveling along the lines that connect blocks the way electrical signals travel along a telephone wire. This analogy is misleading because it suggests that a block diagram represents physical connections between blocks, which is not the case. Simulink signals are mathematical, not physical, entities and the lines in a block diagram represent mathematical, not physical, relationships among signals.

Creating Signals

You can create signals by creating source blocks in your model. For example, you can create a signal that varies sinusoidally with time by dragging an instance of the Sine block from the Simulink Sources library into the model. See “Sources” in the online “Block Libraries” reference for information on blocks that you can use to create signals in a model. You can also use the Signal & Scope Manager to create signals in your model without using blocks. See “The Signal & Scope Manager” on page 6-16 for more information.

Signal Labels

A signal label is text that appears next to the line that represents a signal that has a name. The signal label displays the signal’s name. In addition, if the signal is a virtual signal (see “Virtual Signals” on page 6-4) and its **Show propagated signals** property is on (see “Show propagated signals” on

page 6-31), the label displays the names of the signals that make up the virtual signal.

Simulink creates a label for a signal when you assign it a name in the **Signal Properties** dialog box (see “Signal Properties Dialog Box” on page 6-30). You can change the signal’s name by editing its label on the block diagram. To edit the label, left-click the label. Simulink replaces the label with an edit field. Edit the name in the edit field, then press **Enter** or click outside the label to confirm the change.

Displaying Signal Values

As with creating signals, you can use either blocks or the Signal & Scope Manager to display the values of signals during a simulation. For example, you can use either the Scope block or the Signal & Scope Manager to graph time-varying signals on an oscilloscope-like display during simulation. See “Sinks” in the online “Block Libraries” reference for information on blocks that you can use to display signals in a model.

Signal Data Types

Data type refers to the format used to represent signal values internally. The data type of Simulink signals is double by default. However, you can create signals of other data types. Simulink supports the same range of data types as MATLAB. See “Working with Data Types” on page 7-2 for more information.

Signal Dimensions

Simulink blocks can output one- or two-dimensional signals. A one-dimensional (1-D) signal consists of a stream of one-dimensional arrays output at a frequency of one array (vector) per simulation time step. A two-dimensional (2-D) signal consists of a stream of two-dimensional arrays emitted at a frequency of one 2-D array (matrix) per block sample time. The Simulink user interface and documentation generally refer to 1-D signals as *vectors* and 2-D signals as *matrices*. A one-element array is frequently referred to as a *scalar*. A *row vector* is a 2-D array that has one row. A *column vector* is a 2-D array that has one column.

Simulink blocks vary in the dimensionality of the signals they can accept or output during simulation. Some blocks can accept or output signals of any dimensions. Some can accept or output only scalar or vector signals. To

determine the signal dimensionality of a particular block, see the block's description in "Simulink Blocks" in the online Simulink Help. See "Determining Output Signal Dimensions" on page 6-12 for information on what determines the dimensions of output signals for blocks that can output nonscalar signals.

Complex Signals

The values of Simulink signals can be complex numbers. A signal whose values are complex numbers is called a complex signal. You can introduce a complex-valued signal into a model in the following ways:

- Load complex-valued signal data from the MATLAB workspace into the model via a root-level inport.
- Create a Constant block in your model and set its value to a complex number.
- Create real signals corresponding to the real and imaginary parts of a complex signal, then combine the parts into a complex signal, using the Real-Imag to Complex conversion block.

You can manipulate complex signals via blocks that accept them. If you are not sure whether a block accepts complex signals, see the documentation for the block in the "Simulink Blocks" section of the Simulink online documentation.

Virtual Signals

A *virtual signal* is a signal that represents another signal graphically. Some blocks, such as Bus Creator, Inport, and Outport blocks (see "Virtual Blocks" on page 5-2), generate virtual signals either exclusively or optionally (see "Virtual Versus Nonvirtual Buses" on page 6-7). Virtual signals are purely graphical entities. They have no mathematical or physical significance. Simulink ignores them when simulating a model.

Whenever you run or update a model, Simulink determines the nonvirtual signal(s) represented by the model's virtual signal(s), using a procedure known as *signal propagation*. When running the model, Simulink uses the corresponding nonvirtual signal(s), determined via signal propagation, to drive the blocks to which the virtual signals are connected. Consider, for example, the following model.

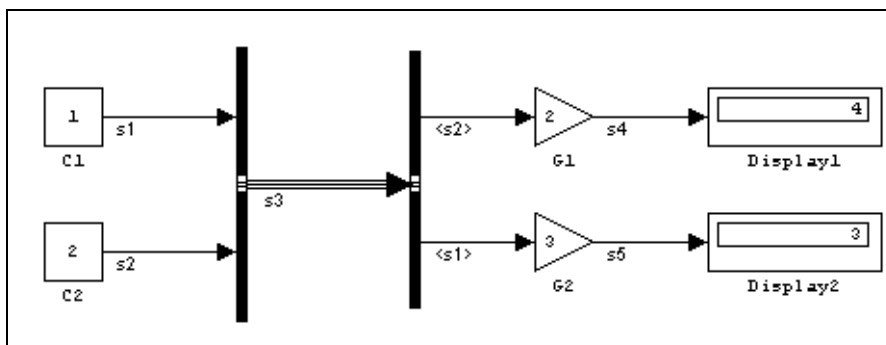

The signals driving Gain blocks G1 and G2 are virtual signals corresponding to signals s2 and s1, respectively. Simulink determines this automatically whenever you update or simulate the model.

The **Show propagated signals** option (see “Signal Properties Dialog Box” on page 6-30) displays the nonvirtual signals represented by virtual signals in the labels of the virtual signals.

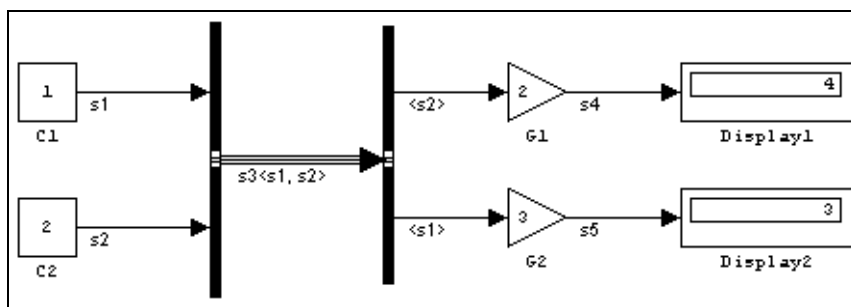

Note Virtual signals can represent virtual as well as nonvirtual signals. For example, you can use a Bus Creator block to combine multiple virtual and nonvirtual signals into a single virtual signal. If during signal propagation Simulink determines that a component of a virtual signal is itself virtual, Simulink determines its nonvirtual components using signal propagation. This process continues until Simulink has determined all nonvirtual components of a virtual signal.

Control Signals

A *control signal* is a signal used by one block to initiate execution of another block, e.g., a function-call or action subsystem. When you update or start simulation of a block diagram, Simulink uses a dash-dot pattern to redraw lines representing the diagram's control signals as illustrated in the following example.

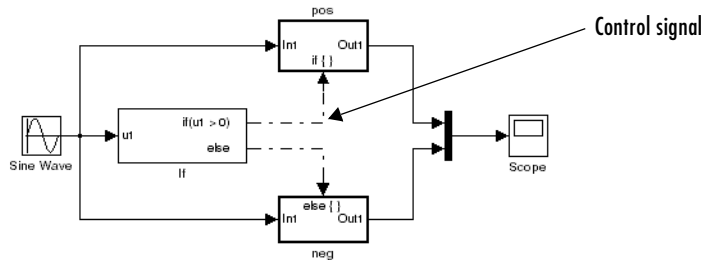

Signal Buses

A bus is a composite signal comprising a set of signals represented graphically by a bundle of lines. It is analogous to a bundle of wires held together by tie wraps. The components of a bus can have different data types and can themselves be composite signals (i.e., buses or muxed signals). You can use Bus Creator and Inport blocks to create signal buses and Bus Selector blocks to access a bus's components.

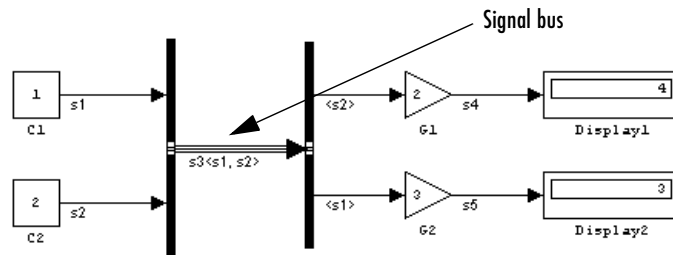

Selecting a bus and then **Signal Dimensions** from the model editor's **Format** menu displays the number of signal components carried by the bus.

Virtual Versus Nonvirtual Buses

Buses may be either virtual or nonvirtual. During simulation, blocks connected to a virtual bus read their inputs from memory allocated to the component signals, which may reside in noncontiguous areas of memory. By contrast, blocks connected to a nonvirtual bus read their inputs from a copy of the component signals maintained by Simulink in a contiguous area of memory allocated to the bus.

Some Simulink features, such as model referencing (see “Referencing Models” on page 4-53), require use of nonvirtual signals. Others require virtual buses. Nonvirtual buses also facilitate code generation by enabling buses to be represented by data structures. On the other hand, nonvirtual buses can save memory where nonvirtual buses are not required.

The Bus Creator and Inport blocks output virtual buses by default. To cause them to output a nonvirtual bus, select the **Output as structure** option on their parameter dialog boxes. You can also use the Signal Conversion block to convert nonvirtual to virtual buses, and vice versa.

Bus-Capable Blocks

A *bus-capable block* is a block through which both virtual and nonvirtual buses can pass. All virtual blocks are bus capable. Further, the following nonvirtual blocks are also bus-capable:

- Memory
- Merge
- Switch
- Multiport Switch
- Rate Transition
- Unit Delay
- Zero-Order Hold

Some bus-capable blocks impose constraints on bus propagation through them. See the documentation for the individual blocks for more information.

Connecting Buses to Subsystem Inports

Generally, an Inport block is a virtual block and hence accepts a bus as input. However, an Inport block is nonvirtual if it resides in a conditionally executed or atomic subsystem and it or any of its components is directly connected to an

output of the subsystem. In such a case, the Inport block can accept a bus only if its components have the same data type. If the components are of differing data types, attempting to simulate the model causes Simulink to halt the simulation and display an error message. You can avoid this problem, without changing the semantics of your model, by inserting a Signal Conversion block between the Inport block and the Outputport block to which it was originally connected.

Consider, for example, the following model.

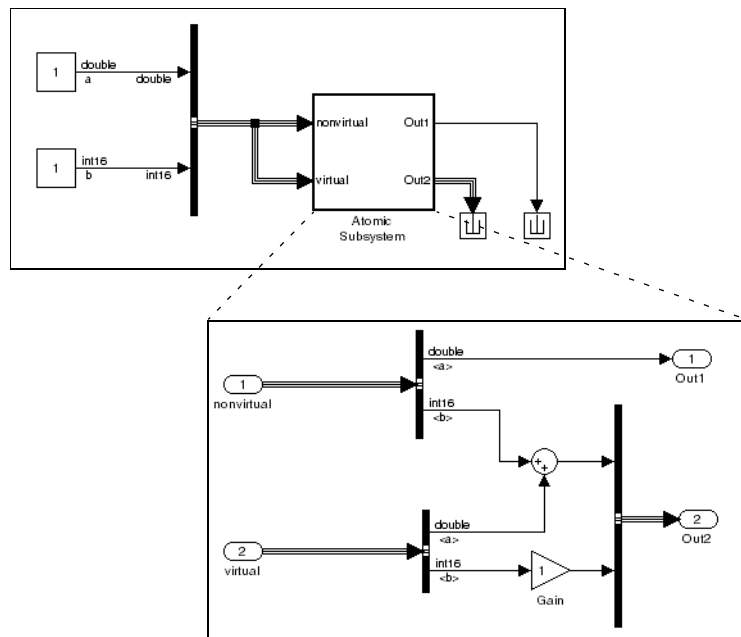

In this model, the Inport labeled `nonvirtual` is nonvirtual because it resides in an atomic subsystem and one of its components (labeled `a`) is directly connected to one of the subsystem's outputs. Further, the bus connected to the subsystem's inputs has components of differing data types. As a result, Simulink cannot simulate this model.

Inserting a Signal Conversion block with the bus copy option selected breaks the direct connection to the subsystem's output and hence enables Simulink to simulate the model.

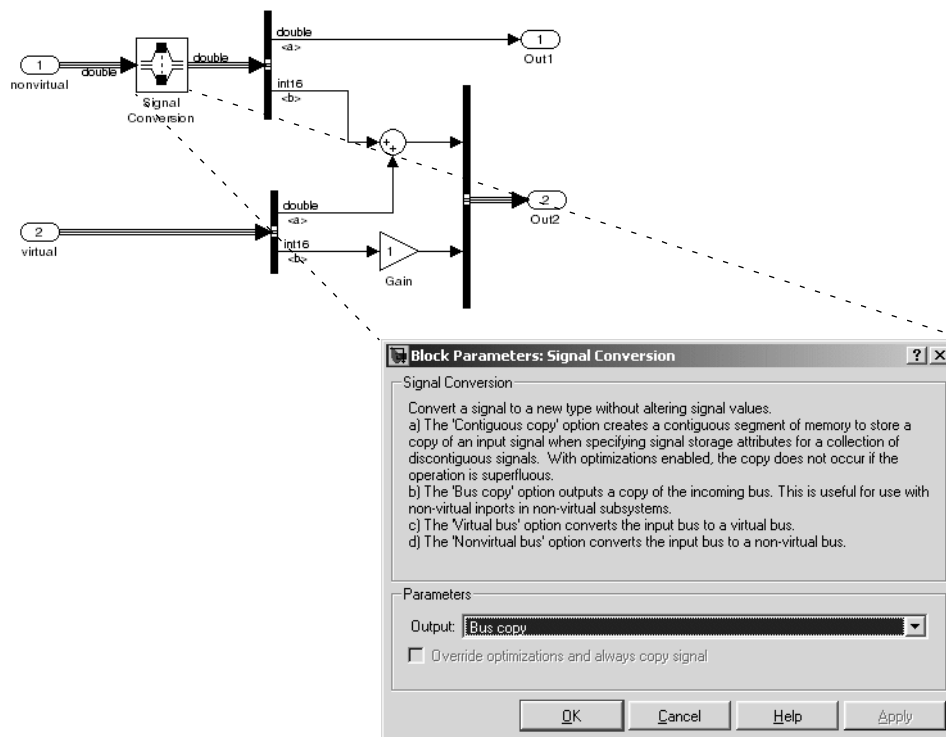

Connecting Buses to Model Inports

If you want a root level Inport of a model to be able to accept a bus signal, you must set the Inport's bus object parameter to the name of a bus object that defines the type of bus that the Inport accepts. See “Working with Data Objects” on page 7-10 and Simulink.Bus class for more information.

Checking Signal Connections

Many Simulink blocks have limitations on the types of signals they can accept. Before simulating a model, Simulink checks all blocks to ensure that they can accommodate the types of signals output by the ports to which they are

connected. If any incompatibilities exist, Simulink reports an error and terminates the simulation. To detect such errors before running a simulation, choose **Update Diagram** from the Simulink **Edit** menu. Simulink reports any invalid connections found in the process of updating the diagram.

Signal Glossary

The following table summarizes the terminology used to describe signals in the Simulink user interface and documentation.

Term	Meaning
Complex signal	Signal whose values are complex numbers.
Data type	Format used to represent signal values internally. See “Working with Data Types” on page 7-2 for more information.
Matrix	Two-dimensional signal array.
Real signal	Signal whose values are real (as opposed to complex) numbers.
Scalar	One-element array, i.e., a one-element, 1-D or 2-D array.
Signal bus	A composite signal made up of other signals, including other buses. You can use Bus Creator, Mux, and Inport blocks to create signal buses.
Signal propagation	Process used by Simulink to determine attributes of signals and blocks, such as data types, labels, sample time, dimensionality, and so on, that are determined by connectivity.
Size	Number of elements that a signal contains. The size of a matrix (2-D) signal is generally expressed as M-by-N where M is the number of columns and N is the number of rows making up the signal.

Term	Meaning
Test point	A signal that must be accessible during simulation (see “Signal Properties Dialog Box” on page 6-30).
Vector	One-dimensional signal array.
Virtual signal	Signal that represents another signal or set of signals.
Width	Size of a vector signal.

Determining Output Signal Dimensions

If a block can emit nonscalar signals, the dimensions of the signals that the block outputs depend on the block's parameters, if the block is a source block; otherwise, the output dimensions depend on the dimensions of the block's input and parameters.

Determining the Output Dimensions of Source Blocks

A *source* block is a block that has no inputs. Examples of source blocks include the Constant block and the Sine Wave block. See the “Sources Library” table in the online Simulink Help for a complete listing of Simulink source blocks. The output dimensions of a source block are the same as those of its output value parameters if the block's **Interpret Vector Parameters as 1-D** parameter is off (i.e., not selected in the block's parameter dialog box). If the **Interpret Vector Parameters as 1-D** parameter is on, the output dimensions equal the output value parameter dimensions unless the parameter dimensions are N-by-1 or 1-by-N. In the latter case, the block outputs a vector signal of width N.

As an example of how a source block's output value parameter(s) and **Interpret Vector Parameters as 1-D** parameter determine the dimensionality of its output, consider the Constant block. This block outputs a constant signal equal to its **Constant value** parameter. The following table illustrates how the dimensionality of the **Constant value** parameter and the setting of the **Interpret Vector Parameters as 1-D** parameter determine the dimensionality of the block's output.

Constant Value	Interpret Vector Parameters as 1-D	Output
2-D scalar	off	2-D scalar
2-D scalar	on	1-D scalar
1-by-N matrix	off	1-by-N matrix
1-by-N matrix	on	N-element vector
N-by-1 matrix	off	N-by-1 matrix
N-by-1 matrix	on	N-element vector

Constant Value	Interpret Vector Parameters as 1-D	Output
M-by-N matrix	off	M-by-N matrix
M-by-N matrix	on	M-by-N matrix

Simulink source blocks allow you to specify the dimensions of the signals that they output. You can therefore use them to introduce signals of various dimensions into your model.

Determining the Output Dimensions of Nonsource Blocks

If a block has inputs, the dimensions of its outputs are, after scalar expansion, the same as those of its inputs. (All inputs must have the same dimensions, as discussed in the next section.)

Signal and Parameter Dimension Rules

When creating a Simulink model, you must observe the following rules regarding signal and parameter dimensions.

Input Signal Dimension Rule

All nonscalar inputs to a block must have the same dimensions.

A block can have a mix of scalar and nonscalar inputs as long as all the nonscalar inputs have the same dimensions. Simulink expands the scalar inputs to have the same dimensions as the nonscalar inputs (see “Scalar Expansion of Inputs” on page 6-14), thus preserving the general rule.

Block Parameter Dimension Rule

In general, a block’s parameters must have the same dimensions as the corresponding inputs.

Two seeming exceptions exist to this general rule:

- A block can have scalar parameters corresponding to nonscalar inputs. In this case, Simulink expands a scalar parameter to have the same dimensions as the corresponding input (see “Scalar Expansion of Parameters” on page 6-15), thus preserving the general rule.

- If an input is a vector, the corresponding parameter can be either an N-by-1 or a 1-by-N matrix. In this case, Simulink applies the N matrix elements to the corresponding elements of the input vector. This exception allows use of MATLAB row or column vectors, which are actually 1-by-N or N-by-1 matrices, respectively, to specify parameters that apply to vector inputs.

Vector or Matrix Input Conversion Rules

Simulink converts vectors to row or column matrices and row or column matrices to vectors under the following circumstances:

- If a vector signal is connected to an input that requires a matrix, Simulink converts the vector to a one-row or one-column matrix.
- If a one-column or one-row matrix is connected to an input that requires a vector, Simulink converts the matrix to a vector.
- If the inputs to a block consist of a mixture of vectors and matrices and the matrix inputs all have one column or one row, Simulink converts the vectors to matrices having one column or one row, respectively.

Note You can configure Simulink to display a warning or error message if a vector or matrix conversion occurs during a simulation. See “Vector/matrix block input conversion” on page 10-54 for more information.

Scalar Expansion of Inputs and Parameters

Scalar expansion is the conversion of a scalar value into a nonscalar array of the same dimensions. Many Simulink blocks support scalar expansion of inputs and parameters. Block descriptions in the “Simulink Blocks” section in the online Simulink Help indicate whether Simulink applies scalar expansion to a block’s inputs and parameters.

Scalar Expansion of Inputs

Scalar expansion of inputs refers to the expansion of scalar inputs to match the dimensions of other nonscalar inputs or nonscalar parameters. When the input to a block is a mix of scalar and nonscalar signals, Simulink expands the scalar inputs into nonscalar signals having the same dimensions as the other

nonscalar inputs. The elements of an expanded signal equal the value of the scalar from which the signal was expanded.

The following model illustrates scalar expansion of inputs. This model adds scalar and vector inputs. The input from block Constant1 is scalar expanded to match the size of the vector input from the Constant block. The input is expanded to the vector $[3 \ 3 \ 3]$.

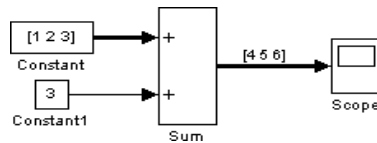

When a block's output is a function of a parameter and the parameter is nonscalar, Simulink expands a scalar input to match the dimensions of the parameter. For example, Simulink expands a scalar input to a Gain block to match the dimensions of a nonscalar gain parameter.

Scalar Expansion of Parameters

If a block has a nonscalar input and a corresponding parameter is a scalar, Simulink expands the scalar parameter to have the same number of elements as the input. Each element of the expanded parameter equals the value of the original scalar. Simulink then applies each element of the expanded parameter to the corresponding input element.

This example shows that a scalar parameter (the Gain) is expanded to a vector of identically valued elements to match the size of the block input, a three-element vector.

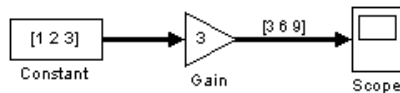

The Signal & Scope Manager

The Signal & Scope Manager lets you globally manage signal generators and viewers.

Note The Signal & Scope Manager requires that you start MATLAB with Java enabled (the default).

To display the Signal & Scope Manager, select **Signal & Scope Manager** from the model editor's **Tools** or context menu. The Signal & Scope Manager appears.

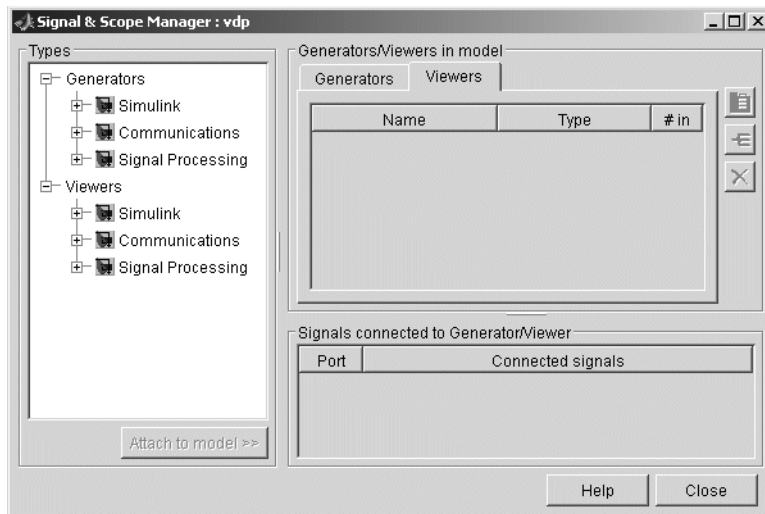

The Signal & Scope Manager contains the following groups of controls.

Generator and Viewer Types

This group of controls lets you create signal generators and viewers of various types and associate them with your model.

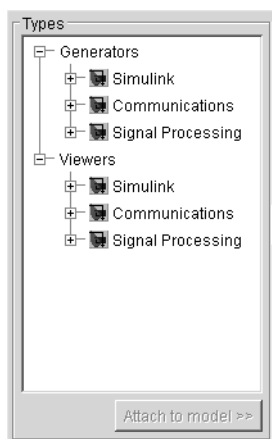

The tree control displays a list of the types of generators and viewers installed on your system. The tree's second-level nodes group the generators and viewers by the products that provides them (i.e., Simulink and any MathWorks blocksets installed on your system). Expand a product's nodes to see the generators and viewers that it provides.

For information on the attributes and usage of the generators and viewers, see the documentation for the identically named source (i.e., generator) and sink (i.e., viewer) blocks in the product's documentation. For example, for information on the generators and viewers provided with Simulink, see the documentation for the corresponding blocks in the Simulink Sources and Sinks libraries.

Note The Scope viewer, unlike the Scope block, cannot log signals to the MATLAB workspace. To log a signal displayed on the Scope viewer, select the signal logging option on the signal's **Signal Properties** dialog box (see “Logging Signals” on page 6-27).

To create an instance of a generator or viewer and associate with the currently selected model, select its type in the type list and then click the **Attach to model** button beneath the list.

Generator and Viewer Objects

This group of controls lets you edit the sources and viewers already associated with your model. It contains the following controls.

Generators

The **Generators** pane displays a table listing the generators associated with your model.

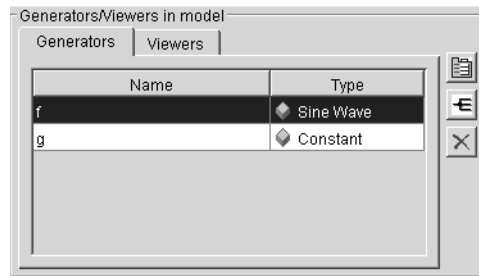

Each row corresponds to a generator. The columns specify each generator's name and type.

Viewers

The **Viewers** pane displays a table listing the viewers associated with your model.

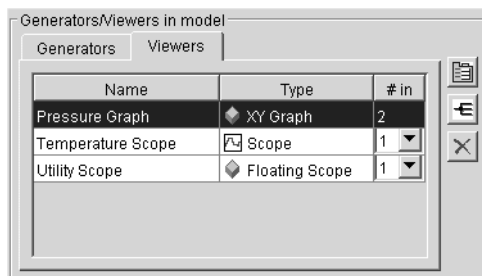



The screenshot shows a dialog box titled "Generators/Viewers in model" with two tabs: "Generators" and "Viewers". The "Viewers" tab is active and displays a table with three columns: "Name", "Type", and "# in". The table contains three rows of viewer information. To the right of the table are three icons: a document icon, a refresh icon, and a close icon.

Name	Type	# in
Pressure Graph	XY Graph	2
Temperature Scope	Scope	1
Utility Scope	Floating Scope	1

Each row corresponds to a viewer. The columns specify each viewer's name, type, and number of inputs. If a viewer accepts a variable number of inputs, the **#in** entry for the viewer contains a pull-down list that displays the range of inputs that the viewer can accept. To change the number of inputs accepted by the viewer, pull down the list and select the desired value.

Edit Buttons

Selecting the table entry for a generator or viewer enables the following buttons.

Button	Description
	<p>Opens the parameter dialog box for the selected generator or viewer. The parameter dialog box enables you to view and change the current settings of the selected object's parameters. See the documentation for the corresponding source or sink block for more information.</p>
	<p>Opens the Signal Selector for the selected generator or viewer. The Signal Selector lets you connect signal generators to your model's inputs and your model's signals to its signal viewers.</p> <hr/> <p>Note You can also use port or signal context menus to connect signals to input ports and output ports to viewers. For example, to connect a signal to a new viewer, select Create Viewer from the signal or output port's context menu, then the type of viewer. To connect a signal to an existing viewer, select Connect to Viewer, then the axis to display the signal. Similarly, to connect a new signal generator to a block input port, select Create Generator from the input port's context menu, then the type of generator.</p> <hr/>
	<p>Deletes the selected generator or viewer.</p>

Edit Menu

Selecting a row in the generator or viewer table and pressing the right button on your mouse displays an edit menu containing entries corresponding to the edit buttons described in the preceding section. It also displays a **Rename** command for renaming the selected object (e.g., a viewer). Selecting this command causes Simulink to replace the selected object's name with an edit control. Use the edit control to rename the object.

Note You can also rename a signal generator on a model's block diagram. To do this, select **Edit Source Name** from the context menu of an input port to which the signal generator is connected. Simulink replaces the source's name with an edit field containing the source's name. Edit the name and then click outside the field or press **Enter** to confirm your changes.

Signals connected to Generator/Viewer

This table lists the signals connected to the generator or viewer selected in the Generator/Viewers control panel of the Signal & Scope Manager.

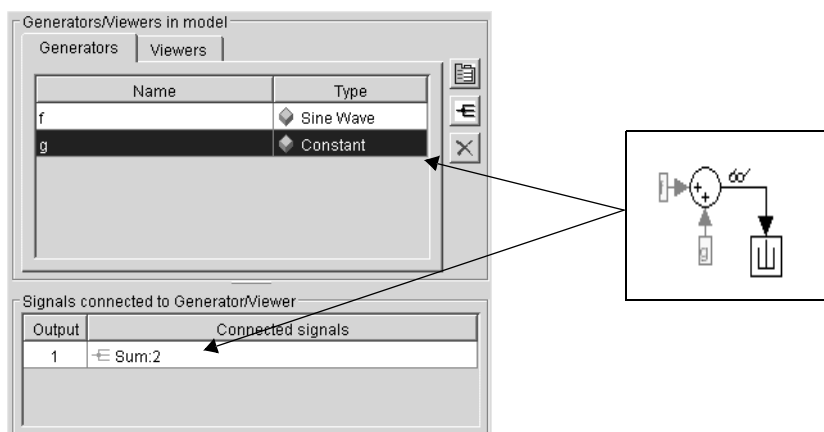

If the selected object is a signal generator, the table lists the block input ports to which each of the generator's outputs is connected. For each connection, the first column of the table specifies the number of the corresponding generator output. The second column specifies the number of the corresponding input port and the name of the block that owns the input port. For example, in the preceding figure, the **Signals connected to Generator/Viewer** table shows that the first (and only) output of the selected Constant generator is connected to the second input port of the block named Sum.

If the selected object is a signal viewer, the **Signals connected to Generator/Viewer** table lists the signals connected to the selected viewer. For each connection, the first column of the table specifies the number of the

corresponding viewer axis. The second column specifies the number of the corresponding output port and the name of the block that owns the output port.

For example, in the next figure, the **Signals connected to Generator/Viewer** table shows that the first axis of the selected signal viewer is connected to the first output port of the block named Sum.

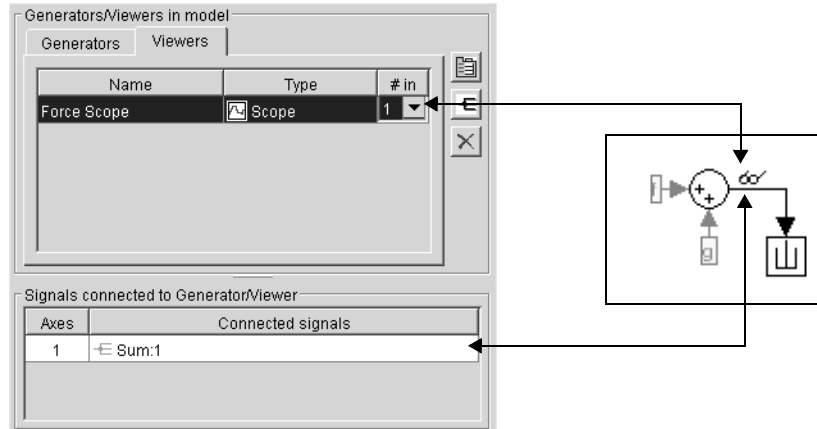

Connection Menu

Selecting a connection in the **Signals connected to Generator/Viewer** table and pressing the right button on your mouse displays a context menu. To highlight the block to which the object is connected, select **Highlight signal in model** from the menu. To open the Signal Selector, select **Edit Signal Connections** from the model.

The Signal Selector

The Signal Selector allows you to connect a signal or viewer object (see “The Signal & Scope Manager” on page 6-16) or the Floating Scope to block inputs and outputs. It appears when you click the signal selection button for a signal or viewer object in the Signal & Scope Manager or on the toolbar of the Floating Scope’s window.

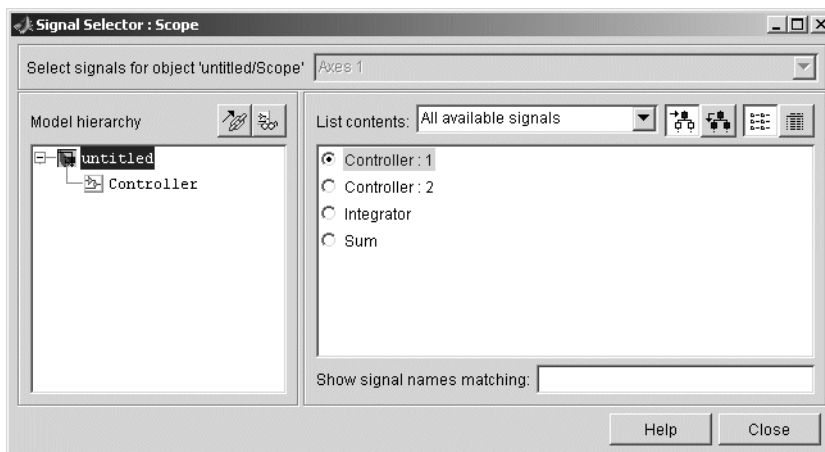

The Signal Selector that appears when you click the signal selection button applies only to the currently selected signal or viewer object (or the Floating Scope). If you want to connect blocks to another signal or viewer object, you must select the object in the Signal & Scope Manager and launch another instance of the Signal Selector. The object used to launch a particular instance of the Signal Selector is called that instance’s owner.

The Signal Selector includes the following control panels.

Port/Axis Selector

This list box allows you to select the owner output port (in the case of signal generators) or display axis (in the case of signal viewers) to which you want to connect blocks in your model.

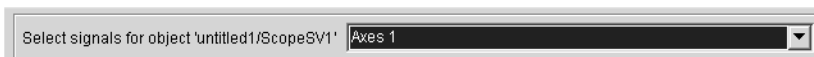

The list box is enabled only if the signal generator has multiple outputs or the signal viewer has multiple axes.

Model Hierarchy

This tree-structured list lets you select any subsystem in your model.

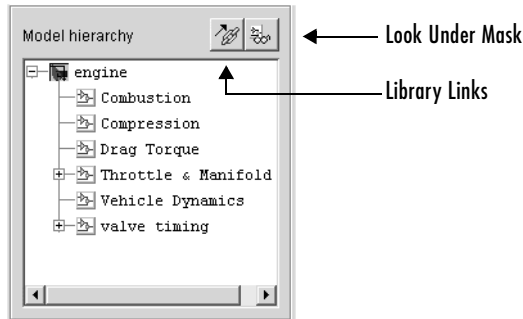

Selecting a subsystem causes the adjacent port list panel to display the ports available for connection in the selected subsystem. To display subsystems included as library links in your model, click the **Library Links** button at the top of the **Model hierarchy** panel. To display subsystems contained by masked subsystems, click the **Look Under Masks** button at the top of the panel.

Inputs/Signals List

The contents of this panel displays input ports available for connection to the Signal Selector's owner if the owner is a signal generator or signals available for connection to the owner if the owner is a signal viewer.

If the Signal Selector's owner is a signal generator, the inputs/signals list by default lists each input port in the system selected in the model hierarchy tree that is either unconnected or connected to a signal generator.

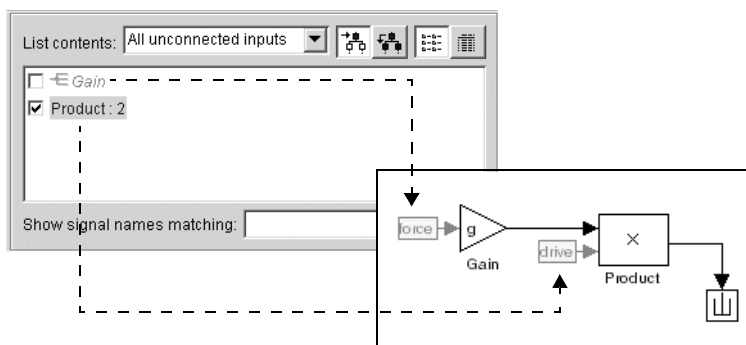

The label for each entry indicates the name of the block of which the port is an input. If the block has more than one input, the label indicates the number of the displayed port. A greyed label indicates that the port is connected to a signal generator other than the Signal Selector's owner. Checking the checkbox next to a port's entry in the list connects the Signal Selector's owner to the port, replacing, if necessary, the signal generator previously connected to the port.

To display more information on each signal, click the **Detailed view** button at the top of the pane. The detailed view shows the path and data type of each signal and whether the signal is a test point. The controls at the top and bottom of the panel let you restrict the amount of information shown in the ports list.

- To show named signals only, select **Named signals only** from the **List contents** control at the top of the pane.
- To show test point signals only, select **Test point signals only** from the **List contents** control.
- To show only signals whose signals match a specified string of characters, enter the characters in the **Show signals matching** control at the bottom of the **Signals** pane and press the **Enter** key.
- To show the selected types of signals for all subsystems below the currently selected subsystem in the model hierarchy, click the **Current and Below** button at the top of the **Signals** pane.

To select or deselect a signal in the **Signals** pane, click its entry or use the arrow keys to move the selection highlight to the signal entry and press the **Enter** key. You can also move the selection highlight to a signal entry by typing the first few characters of its name (enough to uniquely identify it).

Note You can continue to select and deselect signals on the block diagram with the Signal Selector open. For example, shift-clicking a line in the block diagram adds the corresponding signal to the set of signals that you previously selected with the Signal Selector. Simulink updates the Signal Selector to reflect signal selection changes you have made on the block diagram. However, the changes do not appear until you select the Signal Selector window itself.

Logging Signals

Logging signals refers to the process of saving signal values to the MATLAB workspace during simulation for later retrieval and postprocessing. Simulink allows you to log a signal either by connecting the signal to a To Workspace or root-level Inport block or by setting the signal's signal logging properties. The first method allows you to document in the diagram itself the workspace variables used to store signal data. The second method reduces diagram clutter by eliminating the need to use blocks to log signals. Either method allows you to specify the names of the workspace variables used to save signal data and to limit the amount of data logged for a particular signal.

See the documentation for the To Workspace and Inport blocks for information on using these blocks to log and retrieve signal data. The remainder of this section explains how to use signal properties to log and access signal data.

Enabling Signal Logging

To enable signal logging for a signal, check the **Log signal data** option on the signal's **Signal Properties** dialog box (see "Signal Properties Dialog Box" on page 6-30).

Note Simulink does not support signal logging for nonvirtual buses. If you enable signal logging for a nonvirtual bus, Simulink displays an error message when you simulate the model.

Specifying a Logging Name

You can assign a name, called the logging name, to the object used to log data for a signal during simulation. If the signal to be logged does not have a name or is an element of a composite signal that has another element of the same name, you must specify a unique log name for the signal. To specify a log name for a signal, select Custom from the **Logging name** list on the signal's **Signal Properties** dialog box and enter the custom name in the adjacent text field. If a signal has a name you do not need to specify a logging name for the signal, Simulink uses the signal's name as its logging name.

Limiting the Data Logged for a Signal

The **Data** panel of the **Signal Properties** dialog box lets you limit the amount of data logged for a signal. For example, you can specify the maximum amount of data to be logged for a signal or a decimation factor that causes Simulink to skip a specified number of time steps before logging a signal value. See “Data” on page 6-33 for more information.

Logging Referenced Model Signals

To log signals in a model referenced by a Model block, select the Model block and then select **Log referenced signals** from the model editor’s **Edit** menu or from the block’s context menu. The **Model Reference Signal Logging** dialog box appears.

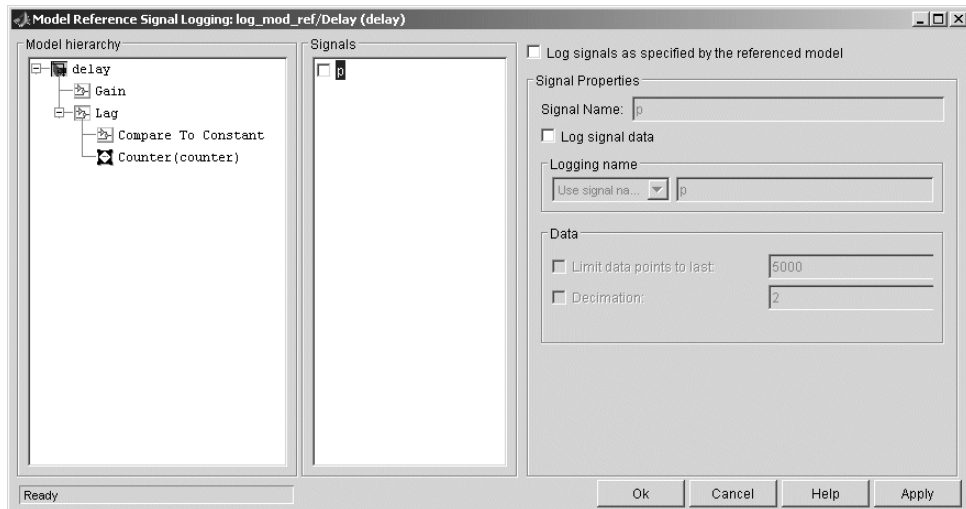

The dialog box contains the following panes and controls.

Model Hierarchy

This pane displays the contents of the referenced model as a tree control with expandable nodes. The top-level node represents the referenced model. Expanding this node displays the subsystems that the referenced model contains and any models that it itself references. Expanding a subsystem node displays the subsystems that it contains and the models that it references.

Signals

This pane displays the test points of the model or subsystem selected in the **Model Hierarchy** pane (see “Working with Test Points” on page 6-35). Check the checkbox next to a test point’s name to specify that it should be logged.

Note Simulink does not support logging of virtual buses in referenced models. If you enable logging for such a bus, Simulink displays a warning message when you simulate the model.

Log signals as specified by the referenced model

Checking this checkbox causes Simulink to log the signals that the referenced model specifies should be logged.

Signal Properties

This pane is enabled if **Log signals as specified by the referenced model** is not selected. In this case, the controls on this pane allow you to specify the signal logging properties of the signal selected in the **Signals** pane. The values that you specify override for this instance of the referenced model those specified by the model itself. The controls correspond to the controls of the same name on the **Signal Properties dialog box**. See “Signal Properties Dialog Box” on page 6-30 for information on how to use them.

Accessing Logged Signal Data

Simulink saves signal data that it logs during simulation in a Simulink data object of type `Simulink.ModelDataLogs` that resides in the MATLAB workspace. The name of the object’s handle is `logsout` by default. The **Data Import/Export** configuration pane (see “Data Import/Export Pane” on page 10-39) allows you to specify another name for this object. See `Simulink.ModelDataLogs` in the “Data Object Classes” chapter of the *Simulink Reference* for information on extracting signal data from this object.

Note Logging data is available only at the end of a simulation. It is not available when the simulation is paused.

Signal Properties Dialog Box

The **Signal Properties** dialog box lets you display and edit signal properties. To display the dialog box, either

- Select the line that represents the signal whose properties you want to set and then choose **Signal Properties** from the signal's context menu or from the Simulink **Edit** menu
- or
- Select the block that outputs the signal and select **Output Port Signal Properties** from the block's context menu

The dialog box appears.

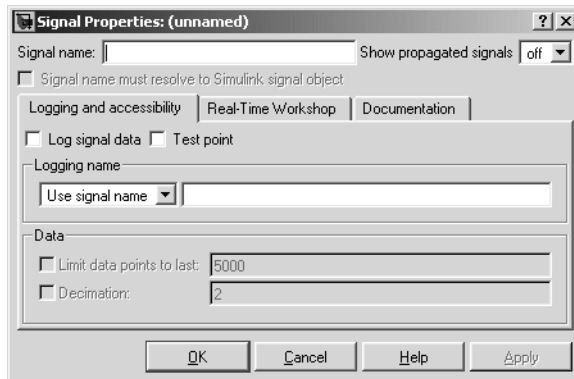

The dialog box includes the follow controls.

Signal name

Name of signal.

Signal name must resolve to a Simulink signal object.

Specifies that the MATLAB workspace must contain a `Simulink.Signal` object with the same name as this signal. Simulink displays an error message if it cannot find such an object when you update or simulate the model containing this signal.

Show propagated signals

Note This option appears only for signals that originate from a virtual block other than a Bus Selector block.

Show propagated signal names. You can select one of the following options:

Option	Description
off	Do not display signals represented by a virtual signal in the signal's label.
on	Display the virtual and nonvirtual signals represented by a virtual signal in the signal's label. For example, suppose that virtual signal s1 represents a nonvirtual signal s2 and a virtual signal s3. If this option is selected, the label for s1 is s1<s2, s3>.
all	Display all the nonvirtual signals that a virtual signal represents either directly or indirectly. For example, suppose that virtual signal s1 represents a nonvirtual signal s2 and a virtual signal s3 and virtual signal s3 represents nonvirtual signals s4 and s5. If this option is selected, the label for s1 is s1<s2, s4, s5>.

Logging and Accessibility Options

Select the **Logging and accessibility** tab on the **Signal Properties** dialog box to display controls that enable you to specify signal logging and accessibility options for this signal.

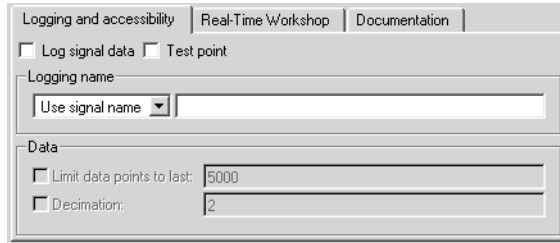

Log signal data

Select this option to cause Simulink to save this signal's values to the MATLAB workspace during simulation (see "Logging Signals" on page 6-27).

Test point

Select this option to designate this signal as a test point (see "Signal Properties Dialog Box" on page 6-30).

Note If you select the **Log signal data** option for this signal, Simulink selects and disables the **Test point** option so that you cannot deselect it. This is because a signal must be a test point to be logged.

Logging name

This pair of controls, consisting of a list box and an edit field, specifies the signal's logging name, i.e., the name under which to be used to retrieve the data that Simulink logs for this signal during simulation.



Simulink uses the signal's signal name as its logging name by default. To specify a custom logging name, select Custom from the list box and enter the custom name in the adjacent edit field.

Data

This group of controls enables you to limit the amount of data that Simulink logs for this signal.

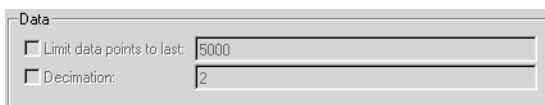

The options are

Limit data points to last. Discard all but the last N data points where N is the number entered in the adjacent edit field.

Decimation. Log every Nth data point where N is the number entered in the adjacent edit field. For example, suppose that your model uses a fixed-step solver with a step size of 0.1 s. if you select this option and accept the default decimation value (2), Simulink records data points for this signal at times 0.0, 0.2, 0.4, etc.

Real-Time Workshop Options

The following controls set properties used by Real-Time Workshop to generate code from the model. You can ignore them if you are not going to generate code from the model.

RTW storage class

Select the storage class of this signal from the list. See the *Real-Time Workshop User's Guide* for an explanation of the listed options.

RTW storage type qualifier

Select the storage type of this signal from the list. See the *Real-Time Workshop User's Guide* for more information.

Documentation Options

Description

Enter a description of the signal in this field.

Document link

Enter a MATLAB expression in the field that displays documentation for the signal. To display the documentation, click “Document Link.” For example, entering the expression

```
web(['file:/// ' which('foo_signal.html')])
```

in the field causes MATLAB’s default Web browser to display `foo_signal.html` when you click the field’s label.

Working with Test Points

A *test point* is a signal that Simulink guarantees to be observable, for example, on a Floating Scope, during a simulation. Simulink allows you to designate any signal in a model as a test point. Designating a signal as a test point exempts the signal from model optimizations, such as signal storage reuse (see “Signal storage reuse” on page 10-46) and block reduction (see “Implement logic signals as boolean data (vs. double)” on page 10-45), that can render signals inaccessible and hence unobservable during simulation.

Designating a Signal as a Test Point

To designate a signal as a test point, check the **Test point** option on the signal’s **Signal Properties** dialog box (see “Signal Properties Dialog Box” on page 6-30).

Note If you enable signal logging for a signal, Simulink designates the signal as a test point automatically. This is because a signal must be accessible to be logged (see “Enabling Signal Logging” on page 6-27 for more information).

Note If you set the test point property of a signal in a library that is referenced by a model that is itself referenced by another model, you must update the referenced model by opening and saving it. Otherwise, Simulink cannot log or display the referenced signal.

Using Signal Objects to Designate Test Points

You can use `Simulink.Signal` objects to designate test points from the MATLAB workspace. This allows you to designate test points in a model without having to modify the model itself. To use a `Simulink.Signal` object to control a signal’s visibility, the following conditions must be true:

- The model does not specify the signal as a test point, i.e., the **Test point** option is unchecked in the **Signal Properties** dialog box.

- The model specifies the signal's storage class as auto (the default), i.e., the **Storage class** option in the signal's **Signal Properties** dialog box is set to auto.
- A Simulink.Signal object is associated with the signal, i.e., the MATLAB workspace contains a signal object having the same name as the signal.

If all these conditions are true, you can designate the signal as a test point by setting the associated object's storage class property to any value but auto.

Displaying Test Point Indicators

By default, Simulink displays an indicator next to each signal that serves as a test point. These test point indicators enable you to find the test points in a model at a glance.

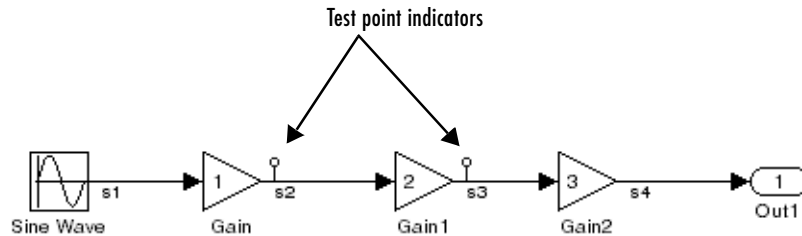

The appearance of the indicator changes slightly to indicate test points for which signal logging is enabled.

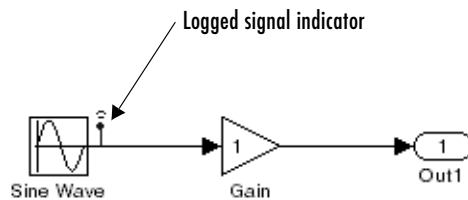

To turn display of test point indicators on or off, select **Port/Signal Displays -> Test Point Indicators** from the Simulink **Format** menu.

Displaying Signal Properties

A model window's **Format** menu and its model context (right-click) menu offer the following options for displaying signal properties on the block diagram.

Wide nonscalar lines

Draws lines that carry vector or matrix signals wider than lines that carry scalar signals.

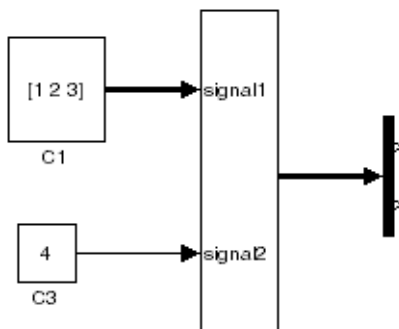

Signal dimensions

Display the dimensions of nonscalar signals next to the line that carries the signal.

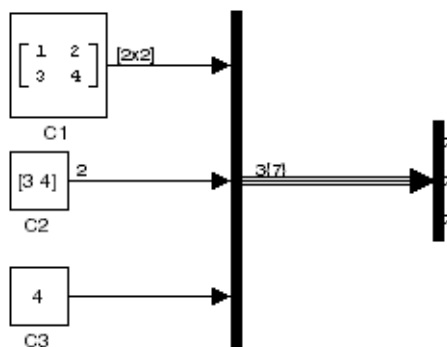

The format of the display depends on whether the line represents a single signal or a bus. If the line represents a single vector signal, Simulink displays the width of the signal. If the line represents a single matrix signal, Simulink displays its dimensions as $[N_1 \times N_2]$ where N_i is the size of the i th dimension of the signal. If the line represents a bus carrying signals of the same data type, Simulink displays $N\{M\}$ where N is the number of signals carried by the bus and M is the total number of signal elements carried by the bus. If the bus carries signals of different data types, Simulink displays only the total number of signal elements $\{M\}$.

Port data types

Displays the data type of a signal next to the output port that emits the signal.

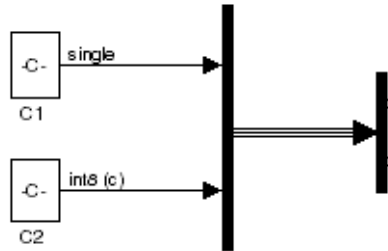

The notation (c) following the data type of a signal indicates that the signal is complex.

Signal Names

You can assign names to signals by

- Editing the signal's label
- Editing the **Name** field of the signal's property dialog (see "Signal Properties Dialog Box" on page 6-30)
- Setting the name parameter of the port or line that represents the signal, e.g.,

```
p = get_param(gcb, 'PortHandles')
l = get_param(p.Inport, 'Line')
set_param(l, 'Name', 's9')
```

Signal Labels

A signal's label displays the signal's name. A virtual signal's label optionally displays the signals it represents in angle brackets. You can edit a signal's label, thereby changing the signal's name.

To create a signal label (and thereby name the signal), double-click the line that represents the signal. The text cursor appears. Enter the name and click anywhere outside the label to exit label editing mode.

Note When you create a signal label, take care to double-click the line. If you click in an unoccupied area close to the line, you will create a model annotation instead.

Labels can appear above or below horizontal lines or line segments, and left or right of vertical lines or line segments. Labels can appear at either end, at the center, or in any combination of these locations.

To move a signal label, drag the label to a new location on the line. When you release the mouse button, the label fixes its position near the line.

To copy a signal label, hold down the **Ctrl** key while dragging the label to another location on the line. When you release the mouse button, the label appears in both the original and the new locations.

To edit an existing signal label, select it:

- To replace the label, click the label, double-click or drag the cursor to select the entire label, then enter the new label.
- To insert characters, click between two characters to position the insertion point, then insert text.
- To replace characters, drag the mouse to select a range of text to replace, then enter the new text.

To delete all occurrences of a signal label, delete all the characters in the label. When you click outside the label, the labels are deleted. To delete a single occurrence of the label, hold down the **Shift** key while you select the label, then press the **Delete** or **Backspace** key.

To change the font of a signal label, select the signal, choose **Font** from the **Format** menu, then select a font from the **Set Font** dialog box.

Displaying Signals Represented by Virtual Signals

To display the signal(s) represented by a virtual signal, click the signal's label and enter an angle bracket (<) after the signal's name. (If the signal has no name, simply enter the angle bracket.) Click anywhere outside the signal's label. Simulink exits label editing mode and displays the signals represented by the virtual signal in brackets in the label.

You can also display the signals represented by a virtual signal by selecting the **Show Propagated Signals** option on the signal's property dialog (see "Signal Properties Dialog Box" on page 6-30).

Working with Signal Groups

The Signal Builder block allows you to create interchangeable groups of signal sources and quickly switch the groups into and out of a model. Signal groups can greatly facilitate testing a model, especially when used in conjunction with Simulink assertion blocks and the optional Model Coverage Tool.

Creating a Signal Group Set

To create an interchangeable set of signal groups:

- 1 Drag an instance of the Signal Builder block from the Simulink Sources library and drop it into your model.

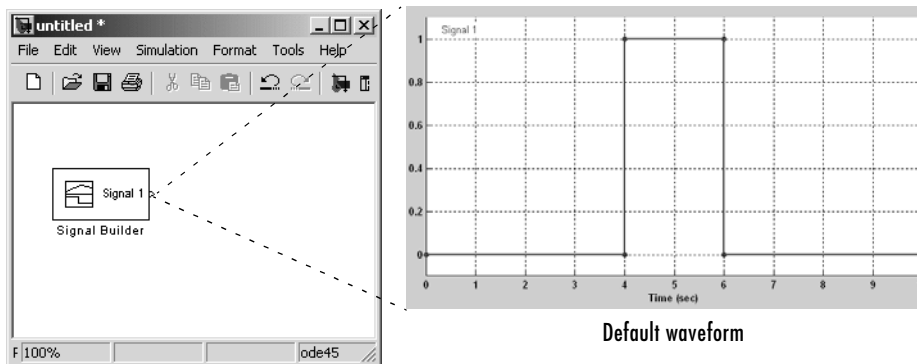

By default, the block represents a single signal group containing a single signal source that outputs a square wave pulse.

- 2 Use the block's signal editor (see “The Signal Builder Dialog Box” on page 6-42) to create additional signal groups, add signals to the signal groups, modify existing signals and signal groups, and select the signal group that the block outputs.
- 3 Connect the output of the block to your diagram.

The block displays an output port for each signal that the block can output.

You can create as many Signal Builder blocks as you like in a model, each representing a distinct set of interchangeable groups of signal sources. See

“Simulating with Signal Groups” on page 6-51 for information on using signal groups in a model.

The Signal Builder Dialog Box

The Signal Builder block’s dialog box allows you to define the waveforms of the signals output by the block. You can specify any waveform that is piecewise linear.

To open the dialog box, double-click the block. The **Signal Builder** dialog box appears.

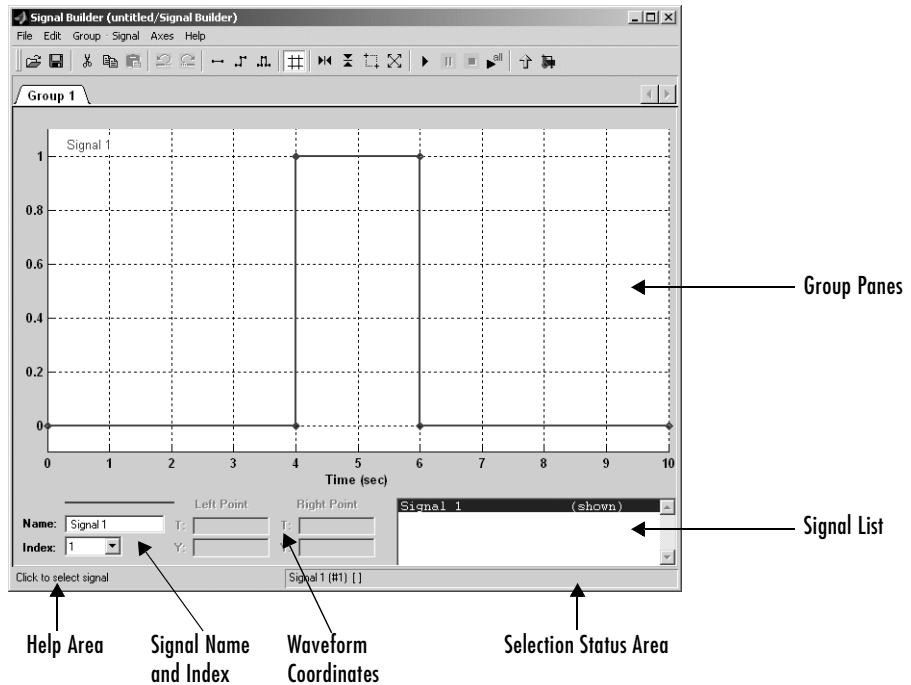

The **Signal Builder** dialog box allows you to create and modify signal groups represented by a Signal Builder block. The **Signal Builder** dialog box includes the following controls.

Group Panes

Displays the set of interchangeable signal source groups represented by the block. The pane for each group displays an editable representation of the waveform of each signal that the group contains. The name of the group appears on the pane's tab. Only one pane is visible at a time. To display a group that is invisible, select the tab that contains its name. The block outputs the group of signals whose pane is currently visible.

Signal Axes

The signals appear on separate axes that share a common time range (see “Signal Builder Time Range” on page 6-50). This allows you to easily compare the relative timing of changes in each signal. The Signal Builder automatically scales the range of each axis to accommodate the signal that it displays. Use the Signal Builder's **Axes** menu to change the time (T) and amplitude (Y) ranges of the selected axis.

Signal List

Displays the names and visibility (see “Editing Signals” on page 6-44) of the signals that belong to the currently selected signal group. Clicking an entry in the list selects the signal. Double-clicking a signal's entry in the list hides or displays the signal's waveform on the group pane.

Selection Status Area

Displays the name of the currently selected signal and the index of the currently selected waveform segment or point.

Waveform Coordinates

Displays the coordinates of the currently selected waveform segment or point. You can change the coordinates by editing the displayed values (see “Editing Waveforms” on page 6-46).

Name

Name of the currently selected signal. You can change the name of a signal by editing this field (see “Renaming a Signal” on page 6-45).

Index

Index of the currently selected signal. The index indicates the output port at which the signal appears. An index of 1 indicates the topmost output port, 2 indicates the second port from the top, and so on. You can change the index of a signal by editing this field (see “Changing a Signal’s Index” on page 6-46).

Help Area

Displays context-sensitive tips on using **Signal Builder** dialog box features.

Editing Signal Groups

The Signal Builder dialog box allows you to create, rename, move, and delete signal groups from the set of groups represented by a Signal Builder block.

Creating and Deleting Signal Groups

To create a signal group, you must copy an existing signal group and then modify it to suit your needs. To copy an existing signal group, select its tab and then select **Copy** from the Signal Builder’s **Group** menu. To delete a group, select its tab and then select **Delete** from the **Group** menu.

Renaming Signal Groups

To rename a signal group, select the group’s tab and then select **Rename** from the Signal Builder’s **Group** menu. A dialog box appears. Edit the existing name in the dialog box or enter a new name. Click **OK**.

Moving Signal Groups

To reposition a group in the stack of group panes, select the pane and then select **Move right** from the Signal Builder’s **Group** menu to move the group lower in the stack or **Move left** to move the pane higher in the stack.

Editing Signals

The **Signal Builder** dialog box allows you to create, cut and paste, hide, and delete signals from signal groups.

Creating Signals

To create a signal in the currently selected signal group, select **New** from the Signal Builder’s **Signal** menu. A menu of waveforms appears. The menu

includes a set of standard waveforms (**Constant**, **Step**, etc.) and a **Custom** waveform option. Select one of the waveforms. If you select a standard waveform, the Signal Builder adds a signal having that waveform to the currently selected group. If you select **Custom**, a custom waveform dialog box appears.

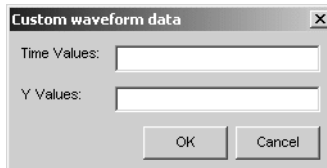

The dialog box allows you to specify a custom piecewise linear waveform to be added to the groups defined by the Signal Builder block. Enter the custom waveform's time coordinates in the **T Values** field and the corresponding signal amplitudes in the **Y Values** field. The entries in either field can be any MATLAB expression that evaluates to a vector. The resulting vectors must be of equal length. Select **OK**. The Signal Builder adds a signal having the specified waveform to the currently selected group.

Cutting and Pasting Signals

To cut or copy a signal from one group and paste it into another group:

- 1 Select the signal you want to cut or copy.
- 2 Select **Cut** or **Copy** from the Signal Builder's **Edit** menu or click the corresponding button from the toolbar.
- 3 Select the group into which you want to paste the signal.
- 4 Select **Paste** from the Signal Builder's **Edit** menu or click the corresponding button on the toolbar.

Renaming a Signal

To rename a signal, select the signal and choose **Rename** from the Signal Builder's **Signal** menu. A dialog box appears with an edit field that displays the signal's current name. Edit or replace the current name with a new name. Click **OK**. Or edit the signal's name in the **Name** field in the lower left corner of the **Signal Builder** dialog box.

Changing a Signal's Index

To change a signal's index, select the signal and choose **Change Index** from the Signal Builder's **Signal** menu. A dialog box appears with an edit field containing the signal's existing index. Edit the field and select **OK**. Or select an index from the **Index** list in the lower left corner of the Signal Builder window.

Hiding Signals

By default, the **Signal Builder** dialog box displays the waveforms of a group's signals in the group's tabbed pane. To hide a waveform, select the waveform and then select **Hide** from the Signal Builder's **Signal** menu. To redisplay a hidden waveform, select the signal's **Group** pane, then select **Show** from the Signal Builder's **Signal** menu to display a menu of hidden signals. Select the signal from the menu. Alternatively, you can hide and redisplay a hidden waveform by double-clicking its name in the Signal Builder's signal list (see "Signal List" on page 6-43).

Editing Waveforms

The **Signal Builder** dialog box allows you to change the shape, color, and line style and thickness of the signal waveforms output by a signal group.

Reshaping a Waveform

The **Signal Builder** dialog box allows you to change the shape of a waveform by selecting and dragging its line segments and points with the mouse or arrow keys or by editing the coordinates of segments or points.

Selecting a Waveform. To select a waveform, left-click the mouse on any point on the waveform.

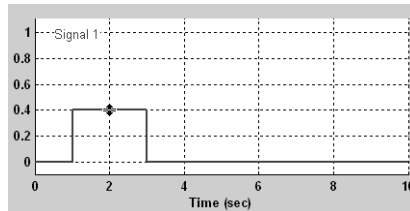

The Signal Builder displays the waveform's points to indicate that the waveform is selected.

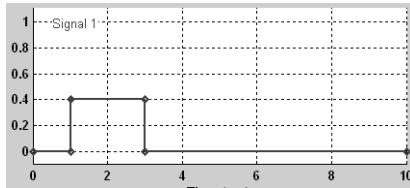

To deselect a waveform, left-click any point on the waveform graph that is not on the waveform itself or press the **Esc** key.

Selecting points. To select a point of a waveform, first select the waveform. Then position the mouse cursor over the point. The cursor changes shape to indicate that it is over a point.

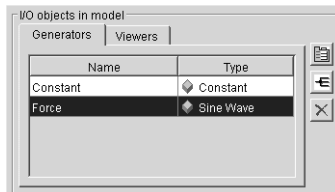

Left-click the point with the mouse. The Signal Builder draws a circle around the point to indicate that it is selected.

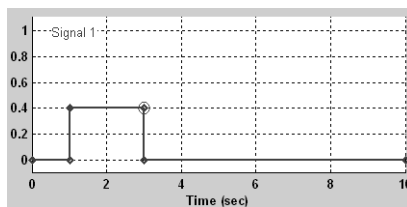

To deselect the point, press the **Esc** key.

Selecting Segments. To select a line segment, first select the waveform that contains it. Then left-click the segment. The Signal Builder thickens the segment to indicate that it is selected.

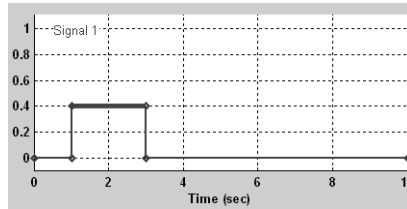

To deselect the segment, press the **Esc** key.

Moving Waveforms. To move a waveform, select it and use the arrow keys on your keyboard to move the waveform in the desired direction. Each key stroke moves the waveform to the next location on the snap grid (see “Snap Grid” on page 6-49) or by 0.1 inches if the snap grid is not enabled.

Dragging Segments. To drag a line segment to a new location, position the mouse cursor over the line segment. The mouse cursor changes shape to show the direction in which you can drag the segment.

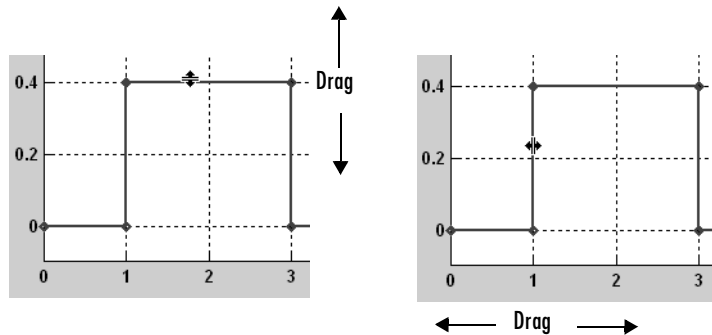

Press the left mouse button and drag the segment in the direction indicated to the desired location. You can also use the arrow keys on your keyboard to move the selected line segment.

Dragging points. To drag a point along the signal amplitude (vertical) axis, move the mouse cursor over the point. The cursor changes shape to a circle to

indicate that you can drag the point. Drag the point parallel to the x -axis to the desired location. To drag the point along the time (horizontal) axis, press the **Shift** key while dragging the point. You can also use the arrow keys on your keyboard to move the selected point.

Snap Grid. Each waveform axis contains an invisible snap grid that facilitates precise positioning of waveform points. The origin of the snap grid coincides with the origin of the waveform axis. When you drop a point or segment that you have been dragging, the Signal Builder moves the point or the segment's points to the nearest point or points on the grid, respectively. The Signal Builder's **Axes** menu allows you to specify the grid's horizontal (time) axis and vertical (amplitude) axis spacing independently. The finer the spacing, the more freedom you have in placing points but the harder it is to position points precisely. By default, the grid spacing is 0, which means that you can place points anywhere on the grid; i.e., the grid is effectively off. Use the **Axes** menu to select the spacing that you prefer.

Inserting and Deleting points. To insert a point, first select the waveform. Then hold down the **Shift** key and left-click the waveform at the point where you want to insert the point. To delete a point, select the point and press the **Del** key.

Editing Point Coordinates. To change the coordinates of a point, first select the point. The Signal Builder displays the current coordinates of the point in the **Left Point** edit fields at the bottom of the **Signal Builder** dialog box. To change the amplitude of the selected point, edit or replace the value in the **y** field with the new value and press **Enter**. The Signal Builder moves the point to its new location. Similarly edit the value in the **t** field to change the time of the selected point.

Editing Segment Coordinates. To change the coordinates of a segment, first select the segment. The Signal Builder displays the current coordinates of the endpoints of the segment in the **Left Point** and **Right Point** edit fields at the bottom of the **Signal Builder** dialog box. To change a coordinate, edit the value in its corresponding edit field and press **Enter**.

Changing the Color of a Waveform

To change the color of a signal waveform, select the waveform and then select **Color** from the Signal Builder's **Signal** menu. The Signal Builder displays the MATLAB color chooser. Choose a new color for the waveform. Click **OK**.

Changing a Waveform's Line Style and Thickness

The Signal Builder can display a waveform as a solid, dashed, or dotted line. It uses a solid line by default. To change the line style of a waveform, select the waveform, then select **Line style** from the Signal Builder's **Signal** menu. A menu of line styles pops up. Select a line style from the menu.

To change the line thickness of a waveform, select the waveform, then select **Line width** from the **Signal** menu. A dialog box appears with the line's current thickness. Edit the thickness value and click **OK**.

Signal Builder Time Range

The Signal Builder's time range determines the span of time over which its output is explicitly defined. By default, the time range runs from 0 to 10 seconds. You can change both the beginning and ending times of a block's time range (see "Changing a Signal Builder's Time Range" on page 6-50).

If the simulation starts before the start time of a block's time range, the block extrapolates its initial output from its first two defined outputs. If the simulation runs beyond the block's time range, the block by default outputs its final defined values for the remainder of the simulation. The Signal Builder's **Simulation Options** dialog box allows you to specify other final output options (see "Signal values after final time" on page 6-52 for more information).

Changing a Signal Builder's Time Range

To change the time range, select **Change time range** from the Signal Builder's **Axes** menu. A dialog box appears.

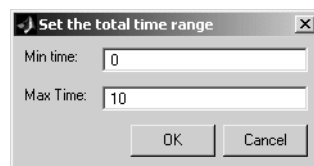

Edit the **Min. time** and **Max. time** fields as necessary to reflect the beginning and ending times of the new time range, respectively. Click **OK**.

Exporting Signal Group Data

To export the data that define a Signal Builder block's signal groups to the MATLAB workspace, select **Export to workspace** from the block's **File** menu. A dialog box appears.

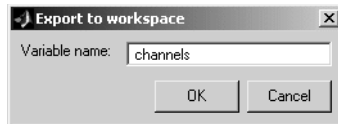

The Signal Builder exports the data by default to a workspace variable named `channels`. To export to a differently named variable, enter the variable's name in the **Variable name** field. Click **OK**. The Signal Builder exports the data to the workspace as the value of the specified variable. The exported data is an array of structures.

Simulating with Signal Groups

You can use standard simulation commands to run models containing Signal Builder blocks or you can use the Signal Builder's **Run all** command (see "Running All Signal Groups" on page 6-51).

Activating a Signal Group

During a simulation, a Signal Builder block always outputs the active signal group. The active signal group is the group selected in the **Signal Builder** dialog box for that block, if the dialog box is open, otherwise the group that was selected when the dialog box was last closed. To activate a group, open the group's **Signal Builder** dialog box and select the group.

Running Different Signal Groups in Succession

The Signal Builder's toolbar includes the standard Simulink buttons for running a simulation. This facilitates running several different signal groups in succession. For example, you can open the dialog box, select a group, run a simulation, select another group, run a simulation, etc., all from the Signal Builder's dialog box.

Running All Signal Groups

To run all the signal groups defined by a Signal Builder block, open the block's dialog box and select the **Run all**  button from the Signal Builder's toolbar.

The **Run all** command runs a series of simulations, one for each signal group defined by the block. If you have installed the optional Model Coverage Tool on your system, the **Run all** command configures the tool to collect and save coverage data for each simulation in the MATLAB workspace and display a report of the combined coverage results at the end of the last simulation. This allows you to quickly determine how well a set of signal groups tests your model.

Note To stop a series of simulations started by the **Run all** command, enter **Control-c** at the MATLAB command line.

Simulation Options Dialog Box

The **Simulation Options** dialog box allows you to specify simulation options pertaining to the Signal Builder. To display the dialog box, select **Simulation Options** from the Signal Builder's **File** menu. The dialog box appears.

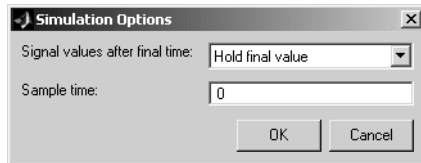

The dialog box allows you to specify the following options.

Signal values after final time

The setting of this control determines the output of the Signal Builder block if a simulation runs longer than the period defined by the block. The options are

- Hold final value

Selecting this option causes the Signal Builder block to output the last defined value of each signal in the currently active group for the remainder of the simulation.

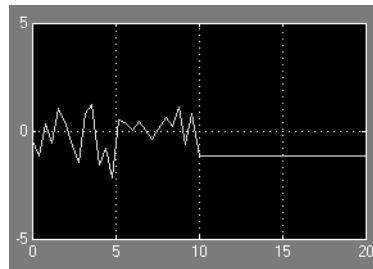

- **Extrapolate**

Selecting this option causes the Signal Builder block to output values extrapolated from the last defined value of each signal in the currently active group for the remainder of the simulation.

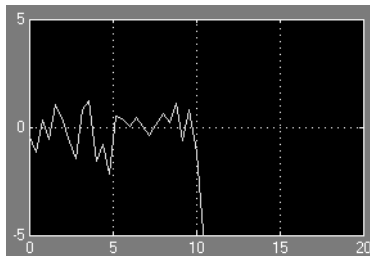

- **Set to zero**

Selecting this option causes the Signal Builder block to output zero for the remainder of the simulation.

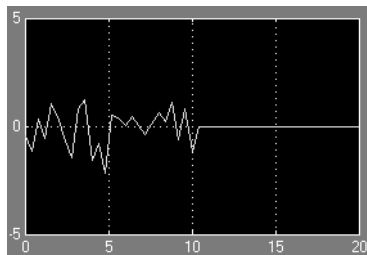

Sample time

Determines whether the Signal Builder block outputs a continuous (the default) or a discrete signal. If you want the block to output a continuous signal, enter 0 in this field. For example, the following display shows the output of a Signal Builder block set to output a continuous Gaussian waveform over a period of 10 seconds.

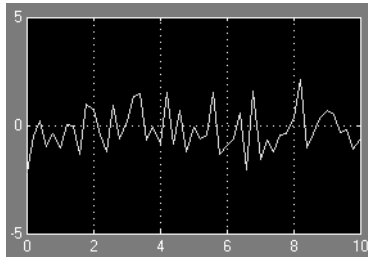

If you want the block to output a discrete signal, enter the sample time of the signal in this field. The following example shows the output of a Signal Builder block set to emit a discrete Gaussian waveform having a 0.5 second sample time.

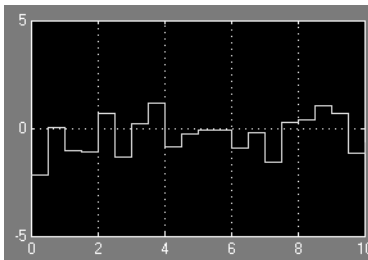

Bus Editor

The Simulink Bus Editor allows you to change the properties of bus type objects, i.e., instances of `Simulink.Bus` class. You can open the Bus Editor in any of the following ways:

- Select **Bus Editor** from the model editor's **Tools** menu.
- Select the **Launch Bus Editor** button on a bus object's dialog box in the Model Explorer.
- Enter `buseditor` at the MATLAB command line.

After you have performed any of these actions, the Bus Editor appears.

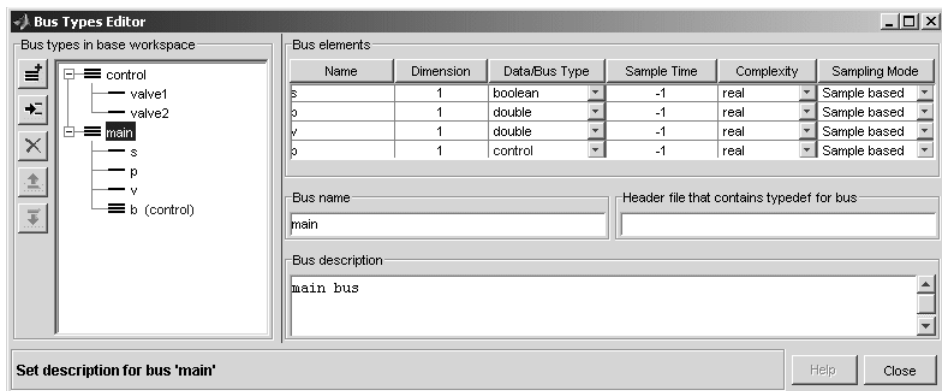

The Bus Editor contains the following groups of controls.

Bus types in base workspace

This group contains a bus object hierarchy pane and a column of editing command buttons.

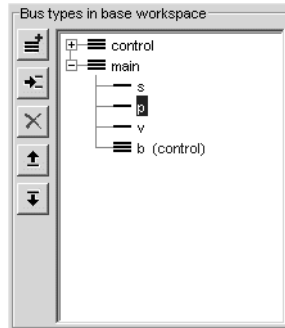





Bus Object Hierarchy Pane

The bus object hierarchy pane displays the structure of bus objects in the Simulink base (i.e., MATLAB) workspace. The pane displays each object as an expandable tree control. The root node of the tree displays the name of the MATLAB variable that references the bus object and, if the bus contains any elements, a button for expanding and collapsing the node. Expanding a bus node displays nodes representing the bus's top-level elements. Each element node displays the element's name. If the element is itself a bus object, the element appears as a bus node that can itself be expanded and collapsed. Selecting any top-level bus object node displays the bus object's properties in the control groups to the right of the bus object hierarchy pane (see below). Selecting any element displays the element's properties in the Bus Editor's **Bus elements** table.

Editing Buttons

This group of buttons allows you to create and modify bus objects in the Simulink base (MATLAB) workspace. It includes the following buttons.

Command	Icon	Description
Create		Create a bus object in the Simulink base (MATLAB) workspace.
Insert		Insert an element in the bus object selected in the Bus Editor's bus object hierarchy pane.
Delete		Delete the bus or bus element selected in the Bus Editor's bus object hierarchy pane.
Move Up		Move the selected element up in the list of a bus object's elements.
Move Down		Move the selected element down in the list of a bus object's elements.

Bus elements

This table displays the properties of the top-level elements of the bus object selected in the bus object hierarchy pane or of the selected element.

Name	Dimension	Data/Bus Type	Sample Time	Complexity	Sampling Mode
s	1	boolean	-1	real	Sample based
o	1	double	-1	real	Sample based
v	1	double	-1	real	Sample based
o	1	control	-1	real	Sample based

The table's cells contain controls that enable you to change the displayed property values. See the documentation for `Simulink.BusElement` class for a description of the usage and valid values for each property.

Bus name

Specifies the name of the workspace variable that references the selected bus object.

Header file

Name of a C header file that defines the user-defined type corresponding to this bus. Simulink ignores this field, which is used by Real-Time Workshop.

Bus description

Description of this bus. Simulink ignores this field.

Working with Data

The following sections explain how to specify the data types of signals and parameters and how to create data objects.

Working with Data Types (p. 7-2)	How to specify the data types of signals and parameters.
Working with Data Objects (p. 7-10)	How to create data objects and use them as signal and parameter values.
Subclassing Simulink Data Classes (p. 7-18)	How to create new types of data objects.
Associating User Data with Blocks (p. 7-30)	How to associate data with a block.

Working with Data Types

The term *data type* refers to the way in which a computer represents numbers in memory. A data type determines the amount of storage allocated to a number, the method used to encode the number's value as a pattern of binary digits, and the operations available for manipulating the type. Most computers provide a choice of data types for representing numbers, each with specific advantages in the areas of precision, dynamic range, performance, and memory usage. To enable you to take advantage of data typing to optimize the performance of MATLAB programs, MATLAB allows you to specify the data types of MATLAB variables. Simulink builds on this capability by allowing you to specify the data types of Simulink signals and block parameters.

The ability to specify the data types of a model's signals and block parameters is particularly useful in real-time control applications. For example, it allows a Simulink model to specify the optimal data types to use to represent signals and block parameters in code generated from a model by automatic code-generation tools, such as Real-Time Workshop available from The MathWorks. By choosing the most appropriate data types for your model's signals and parameters, you can dramatically increase performance and decrease the size of the code generated from the model.

Simulink performs extensive checking before and during a simulation to ensure that your model is *typesafe*, that is, that code generated from the model will not overflow or underflow and thus produce incorrect results. Simulink models that use the default data type (`double`) are inherently typesafe. Thus, if you never plan to generate code from your model or use a nondefault data type in your models, you can skip the remainder of this section.

On the other hand, if you plan to generate code from your models and use nondefault data types, read the remainder of this section carefully, especially the section on data type rules (see "Data Typing Rules" on page 7-6). In that way, you can avoid introducing data type errors that prevent your model from running to completion or simulating at all.

Data Types Supported by Simulink

Simulink supports all built-in MATLAB data types except `int64` and `uint64`. The term *built-in data type* refers to data types defined by MATLAB itself as opposed to data types defined by MATLAB users. Unless otherwise specified, the term data type in the Simulink documentation refers to built-in data types.

The following table lists the built-in MATLAB data types supported by Simulink.

Name	Description
double	Double-precision floating point
single	Single-precision floating point
int8	Signed 8-bit integer
uint8	Unsigned 8-bit integer
int16	Signed 16-bit integer
uint16	Unsigned 16-bit integer
int32	Signed 32-bit integer
uint32	Unsigned 32-bit integer

Besides the built-in types, Simulink defines a `boolean` (1 or 0) type, instances of which are represented internally by `uint8` values. Many Simulink blocks also support fixed-point data types. See “Simulink Blocks” in the online Simulink documentation for information on the data types supported by specific blocks for parameter and input and output values. If the documentation for a block does not specify a data type, the block inputs or outputs only data of type `double`.

Fixed-Point Data

Simulink allows you to create models that use fixed-point numbers to represent signals and parameter values. Use of fixed-point data can reduce the memory requirements and increase the speed of code generated from a model.

To simulate a fixed-point model, you must have the Simulink Fixed Point product installed on your system. If Simulink Fixed Point is not installed on your system, you can simulate a fixed-point model as a floating-point model by enabling automatic conversion of fixed-point data to floating-point data during simulation. See “Fixed-Point Settings Interface” on page 7-4 for more information. If you do not have Simulink Fixed Point installed and do not

enable automatic conversion of fixed-point to floating-point data, Simulink displays an error when you try to simulate a fixed-point model.

You can edit a model containing fixed-point blocks without Simulink Fixed Point. However, you must have Simulink Fixed Point to

- Update a Simulink diagram (**Ctrl+D**) containing fixed-point data types
- Run a model containing fixed-point data types
- Generate code from a model containing fixed-point data types
- Log the minimum and maximum values produced by a simulation
- Automatically scale the output of a model using the autoscaling tool

Fixed-Point Settings Interface

Most of the functionality in the Fixed-Point Settings interface is for use with the Simulink Fixed Point product. However, even if you do not have Simulink Fixed Point, you can use the Fixed-Point Settings interface to perform a data type override that allows you to work with a fixed-point model.

If you do not have Simulink Fixed Point, you can work with a model containing Simulink blocks with fixed-point settings by doing the following:

- 1** Access the **Fixed-Point Settings** interface from the model by selecting **Tools -> Fixed-Point Settings**.
- 2** Set the **Logging mode** parameter to `Force off model wide`.
- 3** Set the **Data type override** parameter to `True doubles` or `True singles model wide`.

This procedure allows you to share fixed-point Simulink models among people in your company who may or may not have Simulink Fixed Point.

Block Support for Data and Numeric Signal Types

All Simulink blocks accept signals of type `double` by default. Some blocks prefer `boolean` input and others support multiple data types on their inputs. See “Simulink Blocks” in the online Simulink documentation for information on the data types supported by specific blocks for parameter and input and

output values. If the documentation for a block does not specify a data type, the block inputs or outputs only data of type double.

Specifying Block Parameter Data Types

When entering block parameters whose data type is user-specifiable, use the syntax

```
type(value)
```

to specify the parameter, where `type` is the name of the data type and `value` is the parameter value. The following examples illustrate this syntax.

<code>single(1.0)</code>	Specifies a single-precision value of 1.0
<code>int8(2)</code>	Specifies an 8-bit integer of value 2
<code>int32(3+2i)</code>	Specifies a complex value whose real and imaginary parts are 32-bit integers

You can specify any MATLAB built-in data type supported by Simulink as the data type of a parameter (see “Data Types Supported by Simulink” on page 7-2). You cannot specify fixed-point data types as parameter data types.

Creating Signals of a Specific Data Type

You can introduce a signal of a specific data type into a model in any of the following ways:

- Load signal data of the desired type from the MATLAB workspace into your model via a root-level inport or a From Workspace block.
- Create a Constant block in your model and set its parameter to the desired type.
- Use a Data Type Conversion block to convert a signal to the desired data type.

Displaying Port Data Types

To display the data types of ports in your model, select **Port Data Types** from the Simulink **Format** menu. Simulink does not update the port data type

display when you change the data type of a diagram element. To refresh the display, type **Ctrl+D**.

Data Type Propagation

Whenever you start a simulation, enable display of port data types, or refresh the port data type display, Simulink performs a processing step called data type propagation. This step involves determining the types of signals whose type is not otherwise specified and checking the types of signals and input ports to ensure that they do not conflict. If type conflicts arise, Simulink displays an error dialog that specifies the signal and port whose data types conflict. Simulink also highlights the signal path that creates the type conflict.

Note You can insert typecasting (data type conversion) blocks in your model to resolve type conflicts. See “Typecasting Signals” on page 7-7 for more information.

Data Typing Rules

Observing the following rules can help you to create models that are typesafe and, therefore, execute without error:

- Signal data types generally do not affect parameter data types, and vice versa.
A significant exception to this rule is the Constant block, whose output data type is determined by the data type of its parameter.
- If the output of a block is a function of an input and a parameter, and the input and parameter differ in type, Simulink converts the parameter to the input type before computing the output.
See “Typecasting Parameters” on page 7-7 for more information.
- In general, a block outputs the data type that appears at its inputs.
Significant exceptions include Constant blocks and Data Type Conversion blocks, whose output data types are determined by block parameters.
- Virtual blocks accept signals of any type on their inputs.
Examples of virtual blocks include Mux and Demux blocks and unconditionally executed subsystems.

- The elements of a signal array connected to a port of a nonvirtual block must be of the same data type.
- The signals connected to the input data ports of a nonvirtual block cannot differ in type.
- Control ports (for example, Enable and Trigger ports) accept any data type.
- Solver blocks accept only double signals.
- Connecting a non-double signal to a block disables zero-crossing detection for that block.

Enabling Strict Boolean Type Checking

By default, Simulink detects but does not signal an error when it detects that double signals are connected to blocks that prefer boolean input. This ensures compatibility with models created by earlier versions of Simulink that support only double data type. You can enable strict Boolean type checking by clearing the **Implement logic signals as boolean data** option on the **Optimization** panel of the **Configuration Parameters** dialog box (see “The options are typically to do nothing or to display a warning or an error message (see “Diagnosing Simulation Errors” on page 10-72). A warning message does not terminate a simulation, but an error message does.” on page 10-48).

Typecasting Signals

Simulink displays an error whenever it detects that a signal is connected to a block that does not accept the signal’s data type. If you want to create such a connection, you must explicitly typecast (convert) the signal to a type that the block does accept. You can use the Data Type Conversion block to perform such conversions.

Typecasting Parameters

In general, during simulation, Simulink silently converts parameter data types to signal data types (if they differ) when computing block outputs that are a function of an input signal and a parameter. The following exceptions to this rule occur:

- If the signal data type cannot represent the parameter value, Simulink halts the simulation and signals an error.

Consider, for example, the following model.

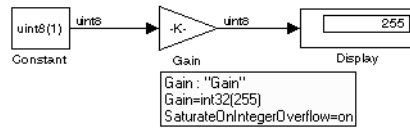

This model uses a Gain block to amplify a constant input signal. Computing the output of the Gain block requires computing the product of the input signal and the gain. Such a computation requires that the two values be of the same data type. However, in this case, the data type of the signal, `uint8` (unsigned 8-bit word), differs from the data type of the gain parameter, `int32` (signed 32-bit integer). Thus computing the output of the Gain block entails a type conversion.

When making such conversions, Simulink always casts the parameter type to the signal type. Thus, in this case, Simulink must convert the Gain block's gain value to the data type of the input signal. Simulink can make this conversion only if the input signal's data type (`uint8`) can represent the gain. In this case, Simulink can make the conversion because the gain is 255, which is within the range of the `uint8` data type (0 to 255). Thus, this model simulates without error. However, if the gain were slightly larger (for example, 256), Simulink would signal an out-of-range error if you attempted to simulate the model.

- If the signal data type can represent the parameter value but only at reduced precision, Simulink optionally issues a warning message and continues the simulation (see “Parameter precision loss” on page 10-53).

Consider, for example, the following model.

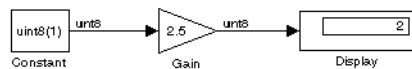

In this example, the signal type accommodates only integer values, while the gain value has a fractional component. Simulating this model causes Simulink to truncate the gain to the nearest integral value (2) and issue a loss-of-precision warning. On the other hand, if the gain were 2.0, Simulink would simulate the model without complaint because in this case the conversion entails no loss of precision.

Note Conversion of an `int32` parameter to a `float` or `double` can entail a loss of precision. The loss can be severe if the magnitude of the parameter value is large. If an `int32` parameter conversion does entail a loss of precision, Simulink issues a warning message.

Working with Data Objects

Simulink allows you to create entities called data objects that specify values, data types, tunability, value ranges, and other key attributes of block outputs and parameters. You can assign such objects to workspace variables and use the variables in Simulink dialog boxes to specify parameter and signal attributes. This allows you to make model-wide changes to parameter and signal specifications simply by changing the values of a few variables. In other words, Simulink objects allow you to parameterize the specification of a model's data attributes.

Note This section uses the term *data* to refer generically to signals and parameters.

Simulink allows you to create various types of data objects, each intended to be used to specify a particular type of data attribute or set of data attributes, such as a data item's type or value. The rest of this section describes features and procedures for working with data objects that apply to all data objects regardless of type. For information on working with specific kinds of data object, see the "Data Object Classes" section of the Simulink Reference.

About Data Object Classes

Simulink uses objects called data classes to define the properties of specific types of data objects. The classes also define functions, called methods, for creating and manipulating instances of particular types of objects. Simulink provides a set of built-in classes for specifying specific types of attributes (see "Data Object Classes" on page 8-1 for information on these built-in classes). Some MathWorks products based on Simulink, such as Real-Time Workshop, also provide classes for specifying data attributes specific to their applications. See the documentation for those products for information on the classes they provide. You can also create subclasses of some of these built-in classes to specify attributes specific to your applications (see "Subclassing Simulink Data Classes" on page 7-18).

Simulink uses memory structures called *packages* to store the code and data that implement data classes. The classes provided by Simulink reside in the Simulink package. Classes provided by products based on Simulink reside in

packages provided by those products. You can create your own packages for storing the classes that you define.

Class Naming Convention

Simulink uses dot notation to name classes:

```
PACKAGE.CLASS
```

where `CLASS` is the name of the class and `PACKAGE` is the name of the package to which the class belongs, for example, `Simulink.Parameter`. This notation allows you to create and reference identically named classes that belong to different packages. In this notation, the name of the package is said to qualify the name of the class.

Note Class and package names are case sensitive. You cannot, for example, use `A.B` and `a.b` interchangeably to refer to the same class.

Handle Versus Value Classes

Simulink data object classes fall into two categories: value classes and handle classes. An instance of a *value* class is permanently associated with the MATLAB variable to which it is initially assigned. Reassigning or passing the variable to a function causes MATLAB to create and assign or pass a copy of the original object. An instance of a *handle* class is associated with a handle object. The handle can be assigned to multiple variables or passed to functions without causing a copy of the original object to be created. A program can modify an instance of a handle class by modifying any variable that references it. Most Simulink data object classes are value classes. Exceptions include `Simulink.Signal` and `Simulink.Parameter` class.

About Data Object Methods

Data classes define functions, called methods, for creating and manipulating the objects that they define. Constructors (see below) are the only methods that you need to use Simulink data objects. The other methods defined by the Simulink built-in data classes are intended for internal use and are not documented.

Constructors

Every data class defines a method for creating instances of that class. The name of the method is the same as the name of the class. For example, the name of the `Simulink.Parameter` class's constructor is `Simulink.Parameter`. The constructors defined by Simulink data classes take no arguments. A constructor returns a handle to the instance that it creates if the class of the instance is a handle class; otherwise, it returns the instance itself (see “Handle Versus Value Classes” on page 7-11).

Creating Data Objects

You can use either the Model Explorer (see next topic) or MATLAB commands (see “Using MATLAB Commands to Create Data Objects” on page 7-13) to create Simulink data objects.

Using the Model Explorer to Create Data Objects

To use the Model Explorer (see “The Model Explorer” on page 9-2) to create data objects, first select the workspace in which you want to create the object in the Model Explorer's **Model Hierarchy** pane.

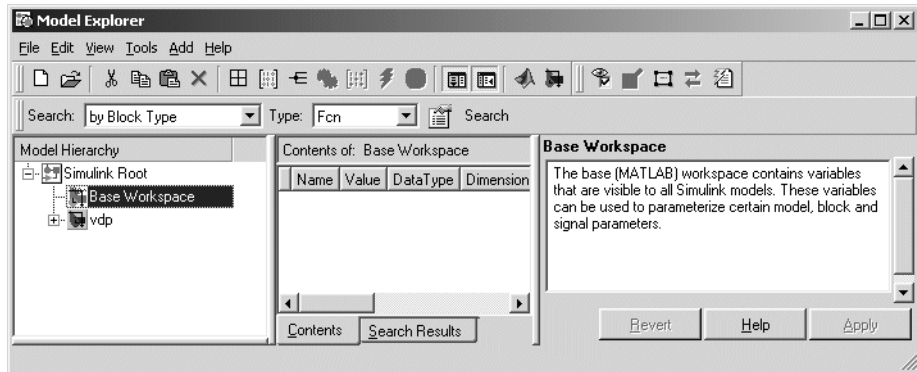

Then, select the type of the object that you want to create (e.g., **Simulink Parameter** or **Simulink Signal**) from the Model Explorer's **Add** menu or from its toolbar. Simulink creates the object, assigns it to a variable in the selected

workspace, and displays its properties in the Model Explorer's **Contents** and **Dialog** panes.

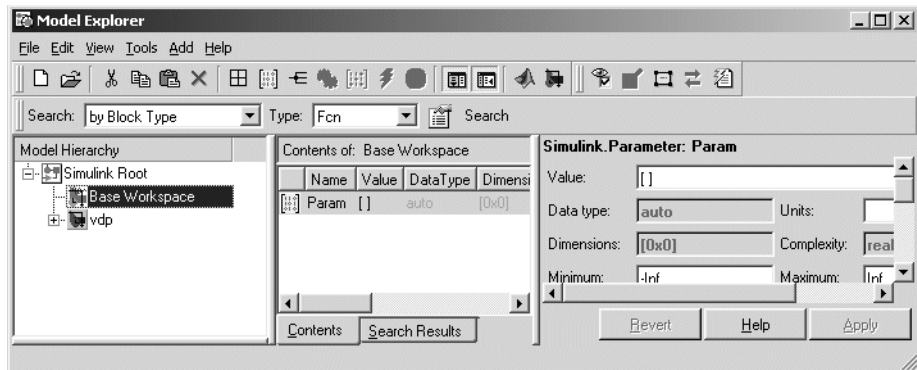

If the type of object you want to create does not appear on the **Add** menu, select **Find Custom** from the menu. Simulink searches the MATLAB path for all data object classes derived from Simulink class on the MATLAB path, including types that you have created, and displays the result in a dialog box.

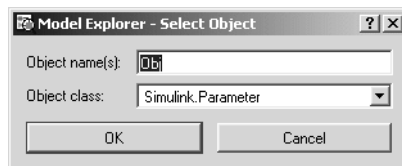

Select the type of object (or objects) that you want to create from the **Object Class** list and enter the names of the workspace variables to which you want the objects to be assigned in the **Object name(s)** field. Simulink creates the specified objects and displays them in the Model Explorer's **Contents** pane.

Using MATLAB Commands to Create Data Objects

You can use data object constructors to create instances of data classes at the MATLAB command line or in MATLAB scripts. For example, the following command creates an instance of a Simulink parameter object:

```
gain = Simulink.Parameter;
```

Note Because `Simulink.Parameter` is a handle class (see “Handle Versus Value Classes” on page 7-11), the value of `gain` is a handle to the newly created object rather than the object itself. You could thus create additional references to the object by assigning `gain` to other variables.

About Object Properties

Object properties are variables associated with an object that specify properties of the entity that the object represents, for example, the size of a data type. The object’s class defines the names, value types, default values, and valid value ranges of the object’s properties.

Changing Object Properties

You can use either the Model Explorer (see next topic) or MATLAB commands to change a data object's properties (see "Using MATLAB Commands to Change an Object's Properties" on page 7-16).

Using the Model Explorer to Change an Object's Properties

To use the Model Explorer to change an object's properties, select the workspace that contains the object in the Model Explorer's **Model Hierarchy** pane. Then select the object in the Model Explorer's **Contents** pane.

The Model Explorer displays the object's property dialog box in its **Dialog** pane (if the pane is visible).

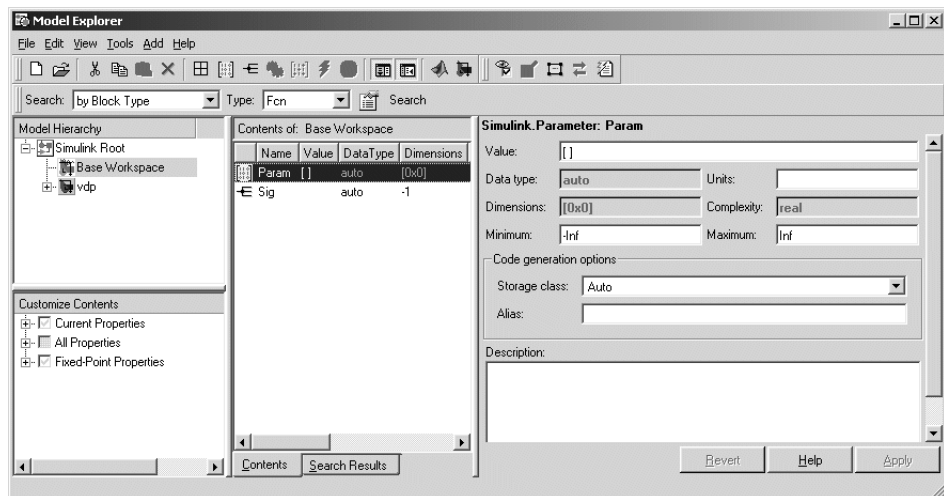

You can configure the Model Explorer to display some or all of the object's properties in the **Contents** pane (see "Customizing the Contents Pane" on page 9-5). To edit a property, click its value in the **Contents** or **Dialog** pane. The value is replaced by a control that allows you to change the value.

Using MATLAB Commands to Change an Object's Properties

You can also use MATLAB commands to get and set data object properties. Use the following dot notation in MATLAB commands and programs to get and set a data object's properties:

```
VALUE = OBJ.PROPERTY;  
OBJ.PROPERTY = VALUE;
```

where OBJ is a variable that references either the object if it is an instance of a value class or a handle to the object if the object is an instance of a handle class (see “Handle Versus Value Classes” on page 7-11), PROPERTY is the property's name, and VALUE is the property's value. For example, the following MATLAB code creates a data type alias object (i.e., an instance of `Simulink.AliasType`) and sets its base type to `uint8`:

```
gain= Simulink.AliasType;  
gain.DataType = 'uint8';
```

Use dot notation recursively to get and set the properties of objects that are values of other object's properties, e.g.,

```
gain.RTWInfo.StorageClass = 'ExportedGlobal';
```

Saving and Loading Data Objects

You can use the MATLAB `save` command to save data objects in a MAT-file and the MATLAB `load` command to restore them to the MATLAB workspace in the same or a later session. Definitions of the classes of saved objects must exist on the MATLAB path for them to be restored. If the class of a saved object acquires new properties after the object is saved, Simulink adds the new properties to the restored version of the object. If the class loses properties after the object is saved, Simulink restores only the properties that remain.

Using Data Objects in Simulink Models

You can use data objects in Simulink models as parameters and signals. Using data objects as parameters and signals allows you to specify simulation and code generation options on an object-by-object basis.

Creating Persistent Data Objects

To create parameter and signal objects that persist across Simulink sessions, first write a script that creates the objects or create the objects with the Simulink **Data Explorer** (see “Subclassing Simulink Data Classes” on page 7-18) or at the command line and save them in a MAT-file (see “Saving and Loading Data Objects” on page 7-16). Then use either the script or a load command as the `PreLoadFcn` callback routine for the model that uses the objects. For example, suppose you save the data objects in a file named `data_objects.mat` and the model to which they apply is open and active. Then, entering the following command

```
set_param(gcs, 'PreLoadFcn', 'load data_objects');
```

at the MATLAB command line sets `load data_objects` as the model’s preload function. This in turn causes the data objects to be loaded into the model workspace whenever you open the model.

Subclassing Simulink Data Classes

The Simulink **Data Class Designer** allows you to create subclasses of some Simulink classes. To define a class with the **Data Class Designer**, you enter the package, name, parent class, properties, and other characteristics of the class in a dialog box. The **Data Class Designer** then generates P-code that defines the class. You can also use the **Data Class Designer** to change the definitions of classes that it created, for example, to add or remove properties.

Note You can use the **Data Class Designer** to create custom storage classes. See the Real-Time Workshop documentation for information on custom storage classes.

Creating a Data Object Class

To create a class with the **Data Class Designer**:

- 1 Select **Data class designer** from the Simulink **Tools** menu.

The **Data Class Designer** dialog box appears.

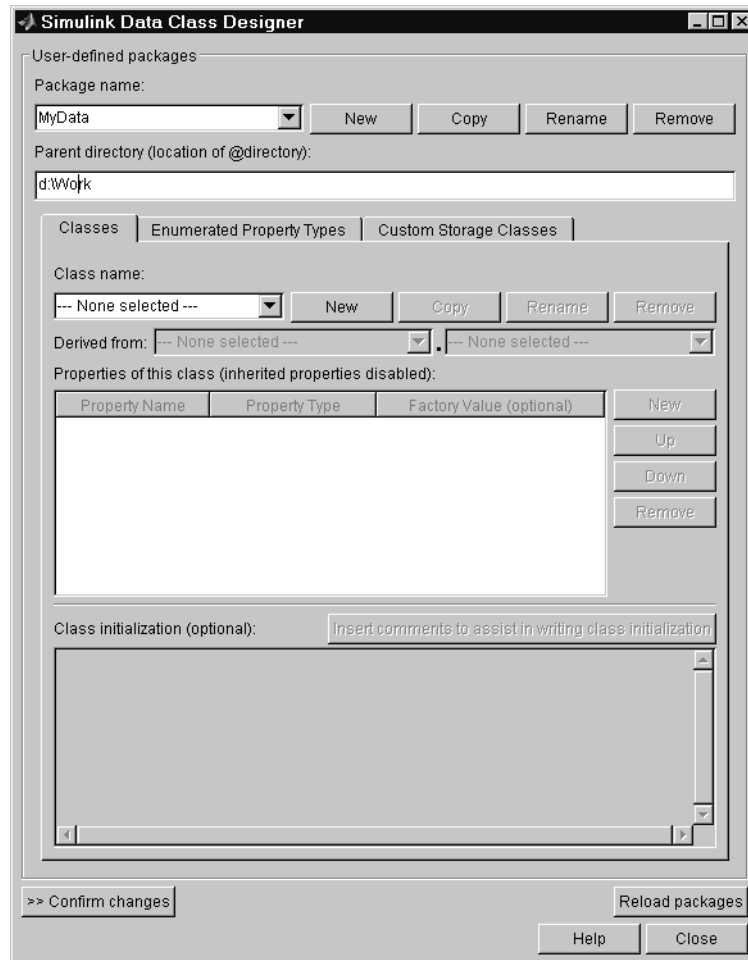

- 2 Select the name of the package in which you want to create the class from the **Package name** list.

Do not create a class in any of the Simulink built-in packages, i.e., packages in `matlabroot/toolbox/simulink`. See “Creating a Class Package” on page 7-28 for information on creating your own class packages.

- 3 Click the **New** button on the **Classes** pane of the **Data Class Designer** dialog box.
- 4 Enter the name of the new class in the **Class name** field on the **Classes** pane.

Note The name of the new class must be unique in the package to which the new class belongs. Class names are case sensitive. For example, Simulink considers `Signal` and `signal` to be names of different classes.

- 5 Press **Enter** or click the **OK** button on the **Classes** pane to create the specified class in memory.
- 6 Select a parent class for the new class (see “Specifying a Parent for a Class” on page 7-22).
- 7 Define the properties of the new class (see “Defining Class Properties” on page 7-23).
- 8 If necessary, create initialization code for the new class (see “Creating Initialization Code” on page 7-27).

9 Click **Confirm changes**.

Simulink displays the **Confirm changes** pane.

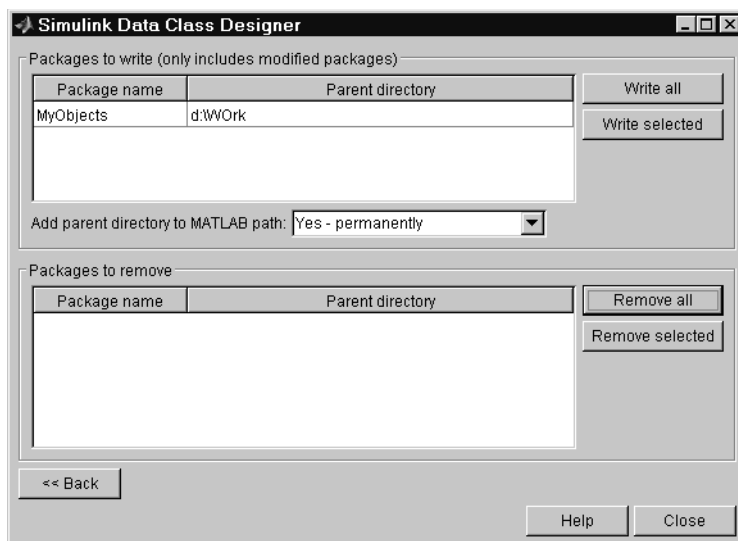

10 Click **Write all** or select the package containing the new class definition and click **Write selected** to save the new class definition.

You can also use the **Classes** pane to perform the following operations.

Copy a class. To copy a class, select the class in the **Classes** pane and click **Copy**. Simulink creates a copy of the class under a slightly different name. Edit the name, if desired, click **Confirm changes**, and click **Write all** or, after selecting the appropriate package, **Write selected** to save the new class.

Rename a class. To rename a class, select the class in the **Classes** pane and click **Rename**. The **Class name** field becomes editable. Edit the field to reflect the new name. Save the package containing the renamed class, using the **Confirm changes** pane.

Remove a class from a package. To remove a class definition from the currently selected package, select the class in the **Classes** pane and click **Remove**.

Simulink removes the class from the in-memory definition of the class. Save the package that formerly contained the class.

Specifying a Parent for a Class

To specify a parent for a class:

- 1 Select the name of the class from the **Class name** field on the **Classes** pane.
- 2 Select the package name of the parent class from the left-hand **Derived from** list box.

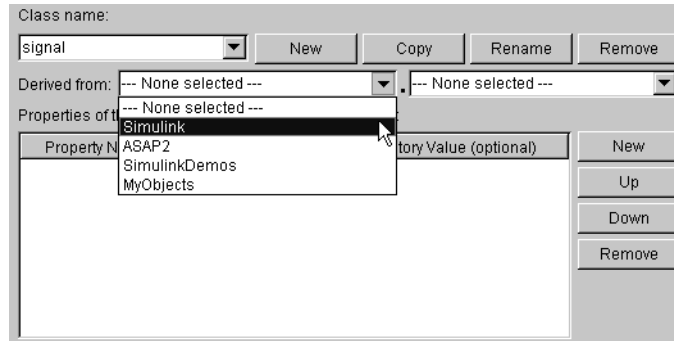

- 3 Select the parent class from the right-hand **Derived from** list.

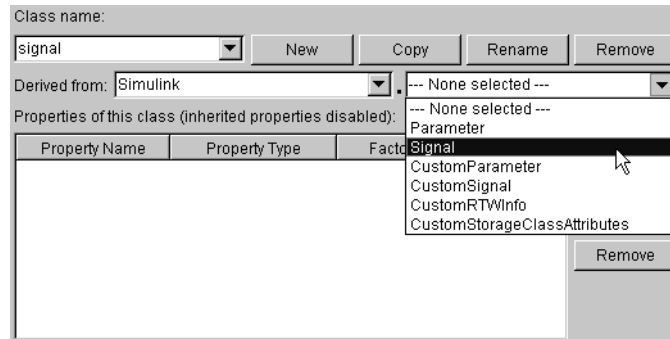

Simulink displays properties of the selected class derived from the parent class in the **Properties of this class** field.



Simulink grays the inherited properties to indicate that they cannot be redefined by the child class.

- 4 Save the package containing the class.

Defining Class Properties

To add a property to a class:

- 1 Select the name of the class from the **Class name** field on the **Classes** pane.
- 2 Select the **New** button next to the **Properties of this class** field on the **Classes** pane.

Simulink creates a property with a default name and value and displays the property in the **Properties of this class** field.

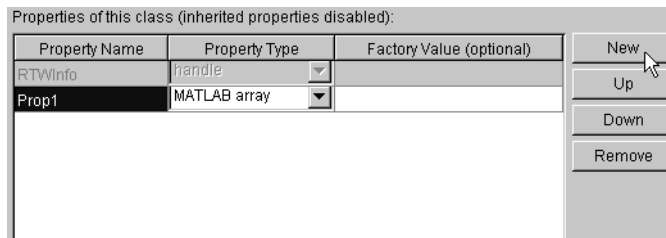

- 3** Enter a name for the new property in the **Property Name** column.

Note The property name must be unique to the class. Unlike class names, property names are not case sensitive. For example, Simulink treats `Value` and `value` as referring to the same property.

- 4** Select the data type of the property from the **Property Type** list.

The list includes built-in property types and any enumerated property types that you have defined (see “Defining Enumerated Property Types” on page 7-25).

- 5** If you want the property to have a default value, enter the default value in the **Factory Value** column.

The default value is the value the property has when an instance of the associated class is created. The initialization code for the class can override this value (see “Creating Initialization Code” on page 7-27 for more information).

The following rules apply to entering factory values for properties:

- Do not use quotation marks when entering the value of a string property. Simulink treats the value that you enter as a literal string.
 - The value of a MATLAB array property can be any expression that evaluates to an array, cell array, structure, or object. Enter the expression exactly as you would enter the value on the command line, for example, `[0 1; 1 0]`. Simulink evaluates the expression that you enter to check its validity. Simulink displays a warning message if evaluating the expression results in an error. Regardless of whether an evaluation error occurs, Simulink stores the expression as the factory value of the property. This is because an expression that is invalid at define time might be valid at run-time.
 - You can enter any expression that evaluates to a numeric value as the value of a `double` or `int32` property. Simulink evaluates the expression and stores the result as the property’s factory value.
- 6** Save the package containing the class with new or changed properties.

Defining Enumerated Property Types

An *enumerated property type* is a property type whose value must be one of a specified set of values, for example, red, blue, or green. An enumerated property type is valid only in the package that defines it.

To create an enumerated property type:

- 1 Select the **Enumerated Property Types** pane of the **Data Class Designer**.

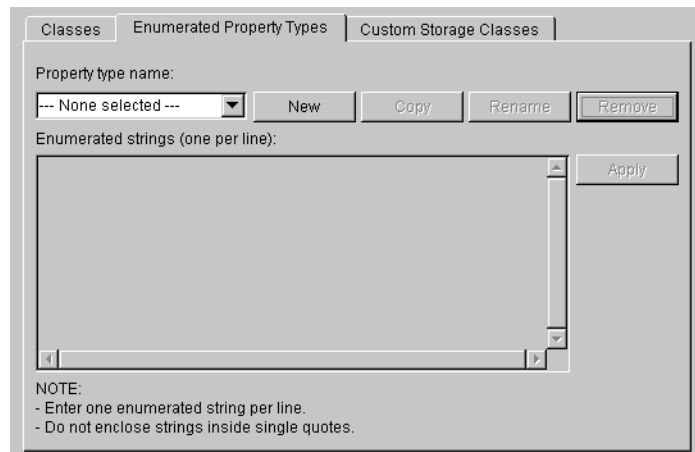

- 2 Click the **New** button next to the **Property type name** field.

Simulink creates an enumerated type with a default name.



- 3 Change the default name in the **Property type name** field to the desired name for the property.

The currently selected package defines an enumerated property type and the type can be referenced only in the package that defines it. However, the name of the enumerated property type must be globally unique. There cannot be any other built-in or user-defined enumerated property with the same name. If you enter the name of an existing built-in or user-defined

enumerated property for the new property, Simulink displays an error message.

- 4 Click the **OK** button.

Simulink creates the new property in memory and enables the **Enumerated strings** field on the **Enumerated Property Types** pane.

- 5 Enter the permissible values for the new property type **Enumerated strings** field, one per line.

For example, the following **Enumerated strings** field shows the permissible values for an enumerated property type named **Color**.

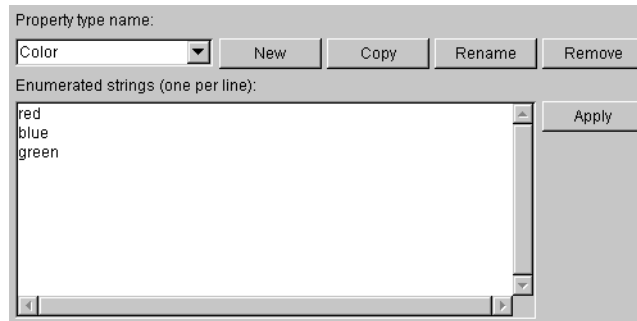

- 6 Click **Apply** to save the changes in memory.
- 7 Click **Confirm changes**. Then click **Write all** to save this change.

You can also use the **Enumerated Property Type** pane to copy, rename, and remove enumerated property types.

- Click the **Copy** button to copy the currently selected property type. Simulink creates a new property that has a new name, but has the same value set as the original property.
- Click the **Rename** button to rename the currently selected property type. The **Property name** field becomes editable. Edit the field to reflect the new name.
- Click the **Remove** button to remove the currently selected property.

Don't forget to save the package containing the modified enumerated property type.

Creating Initialization Code

You can specify code to be executed when Simulink creates an instance of a data object class. To specify initialization code for a class, select the class from the **Class name** field of the **Data Class Designer** and enter the initialization code in the **Class initialization** field.

The **Data Class Designer** inserts the code that you enter in the **Class initialization** field in the class instantiation function of the corresponding class. Simulink invokes this function when it creates an instance of this class. The class instantiation function has the form

```
function h = ClassName(varargin)
```

where *h* is the handle to the object that is created and *varargin* is a cell array that contains the function's input arguments.

By entering the appropriate code in the **Data Class Designer**, you can cause the instantiation function to perform such initialization operations as

- Error checking
- Loading information from data files
- Overriding factory values
- Initializing properties to user-specified values

For example, suppose you want to let a user initialize the `ParamName` property of instances of a class named `MyPackage.Parameter`. The user does this by passing the initial value of the `ParamName` property to the class constructor:

```
Kp = MyPackage.Parameter('Kp');
```

The following code in the instantiation function would perform the required initialization:

```
switch nargin
    case 0
        % No input arguments - no action
    case 1
        % One input argument
        h.ParamName = varargin{1};
```

```

        otherwise
            warning('Invalid number of input arguments');
    end

```

Creating a Class Package

To create a new package to contain your classes:

- 1 Click the **New** button next to the **Package name** field of the **Data Class Designer**.

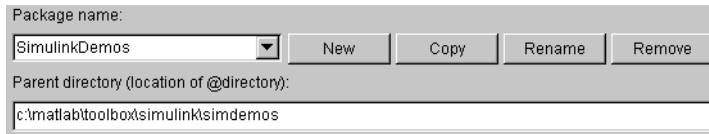

Simulink displays a default package name in the **Package name** field.

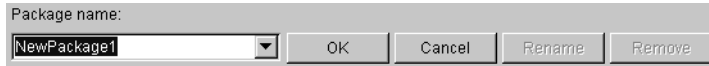

- 2 Edit the **Package name** field to contain the package name that you want.

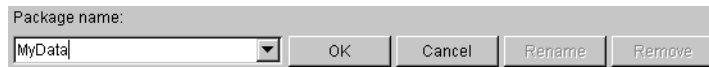

- 3 Click **OK** to create the new package in memory.
- 4 In the package **Parent directory** field, enter the path of the directory where you want Simulink to create the new package.



Simulink creates the specified directory, if it does not already exist, when you save the package to your file system in the succeeding steps.

- 5 Click the **Confirm changes** button on the **Data Class Designer**.

Simulink displays the **Packages to write** panel.

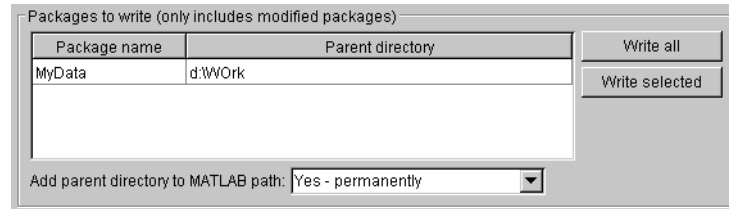

- 6 To enable use of this package in the current and future sessions, ensure that the **Add parent directory to MATLAB path** box is selected (the default).

This adds the path of the new package's parent directory to the MATLAB path.

- 7 Click **Write all** or select the new package and click **Write selected** to save the new package.

You can also use the **Data Class Designer** to copy, rename, and remove packages.

Copying a package. To copy a package, select the package and click the **Copy** button next to the **Package name** field. Simulink creates a copy of the package under a slightly different name. Edit the new name, if desired, and click **OK** to create the package in memory. Then save the package to make it permanent.

Renaming a package. To rename a package, select the package and click the **Rename** button next to the **Package name** field. The field becomes editable. Edit the field to reflect the new name. Save the renamed package.

Removing a package. To remove a package, select the package and click the **Remove** button next to the **Package name** field to remove the package from memory. Click the **Confirm changes** button to display the **Packages to remove** panel. Select the package and click **Remove selected** to remove the package from your file system or click **Remove all** to remove all packages that you have removed from memory from your file system as well.

Associating User Data with Blocks

You can use the Simulink `set_param` command to associate your own data with a block. For example, the following command associates the value of the variable `mydata` with the currently selected block.

```
set_param(gcf, 'UserData', mydata)
```

The value of `mydata` can be any MATLAB data type, including arrays, structures, objects, and Simulink data objects.

Use `get_param` to retrieve the user data associated with a block.

```
get_param(gcf, 'UserData')
```

The following command causes Simulink to save the user data associated with a block in the model file of the model containing the block.

```
set_param(gcf, 'UserDataPersistent', 'on');
```

Note If persistent `UserData` for a block contains any Simulink data objects, the directories containing the definitions for the classes of those objects must be on the MATLAB path when you open the model containing the block.

Modeling with Simulink

The following sections provides tips and guidelines for creating Simulink models.

Modeling Equations (p. 8-2)

How to use Simulink blocks to model mathematical equations.

Avoiding Invalid Loops (p. 8-6)

How to avoid creating invalid loops in your model.

Tips for Building Models (p. 8-8)

Tips on creating efficient, accurate models of a dynamic system.

Modeling Equations

One of the most confusing issues for new Simulink users is how to model equations. Here are some examples that might improve your understanding of how to model equations.

Converting Celsius to Fahrenheit

To model the equation that converts Celsius temperature to Fahrenheit

$$T_F = 9/5(T_C) + 32$$

First, consider the blocks needed to build the model:

- A Ramp block to input the temperature signal, from the Sources library
- A Constant block to define a constant of 32, also from the Sources library
- A Gain block to multiply the input signal by 9/5, from the Math library
- A Sum block to add the two quantities, also from the Math library
- A Scope block to display the output, from the Sinks library

Next, gather the blocks into your model window.

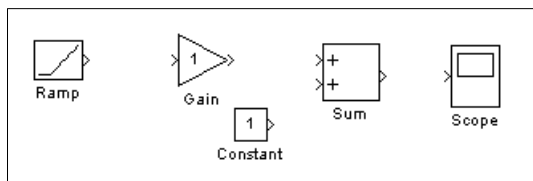

Assign parameter values to the Gain and Constant blocks by opening (double-clicking) each block and entering the appropriate value. Then, click the **Close** button to apply the value and close the dialog box.

Now, connect the blocks.

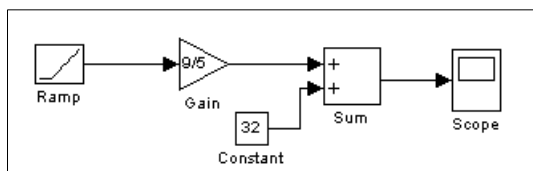

The Ramp block inputs Celsius temperature. Open that block and change the **Initial output** parameter to 0. The Gain block multiplies that temperature by the constant 9/5. The Sum block adds the value 32 to the result and outputs the Fahrenheit temperature.

Open the Scope block to view the output. Now, choose **Start** from the **Simulation** menu to run the simulation. The simulation runs for 10 seconds.

Modeling a Continuous System

To model the differential equation

$$x'(t) = -2x(t) + u(t)$$

where $u(t)$ is a square wave with an amplitude of 1 and a frequency of 1 rad/sec. The Integrator block integrates its input x' to produce x . Other blocks needed in this model include a Gain block and a Sum block. To generate a square wave, use a Signal Generator block and select the Square Wave form but change the default units to radians/sec. Again, view the output using a Scope block. Gather the blocks and define the gain.

In this model, to reverse the direction of the Gain block, select the block, then use the **Flip Block** command from the **Format** menu. To create the branch line from the output of the Integrator block to the Gain block, hold down the **Ctrl** key while drawing the line. For more information, see “Drawing a Branch Line” on page 4-12. Now you can connect all the blocks.

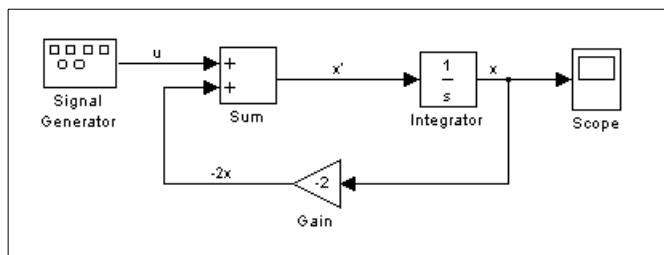

An important concept in this model is the loop that includes the Sum block, the Integrator block, and the Gain block. In this equation, x is the output of the Integrator block. It is also the input to the blocks that compute x' , on which it is based. This relationship is implemented using a loop.

The Scope displays x at each time step. For a simulation lasting 10 seconds, the output looks like this:

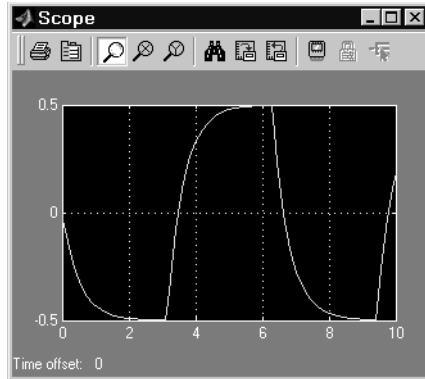

The equation you modeled in this example can also be expressed as a transfer function. The model uses the Transfer Fcn block, which accepts u as input and outputs x . So, the block implements x/u . If you substitute sx for x' in the above equation, you get

$$sx = -2x + u$$

Solving for x gives

$$x = u/(s + 2)$$

or,

$$x/u = 1/(s + 2)$$

The Transfer Fcn block uses parameters to specify the numerator and denominator coefficients. In this case, the numerator is 1 and the denominator

is $s+2$. Specify both terms as vectors of coefficients of successively decreasing powers of s .

In this case the numerator is $[1]$ (or just 1) and the denominator is $[1 \ 2]$.

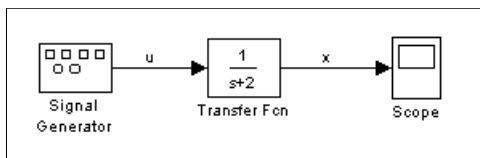

The results of this simulation are identical to those of the previous model.

Avoiding Invalid Loops

Simulink allows you to connect the output of a block directly or indirectly (i.e., via other blocks) to its input, thereby, creating a loop. Loops can be very useful. For example, you can use loops to solve differential equations diagrammatically (see “Modeling a Continuous System” on page 8-3) or model feedback control systems. However, it is also possible to create loops that cannot be simulated. Common types of invalid loops include:

- Loops that create invalid function-call connections or an attempt to modify the input/output arguments of a function call
- Self-triggering subsystems and loops containing non-latched triggered subsystems
- Loops containing action subsystems

The Subsystem Examples block library in the Ports & Subsystems library contains models that illustrates examples of valid and invalid loops involving triggered and function-call subsystems. Examples of invalid loops include the following models:

- `simulink/Ports&Subsystems/sl_subsys_semantics/Triggered subsystem/sl_subsys_trigerr1`
- `simulink/Ports&Subsystems/sl_subsys_semantics/Triggered subsystem/sl_subsys_trigerr2`
- `simulink/Ports&Subsystems/sl_subsys_semantics/Function-call systems/sl_subsys_fcncallerr3`

You might find it useful to study these examples to avoid creating invalid loops in your own models.

Detecting Invalid Loops

To detect whether your model contains invalid loops, select **Update diagram** from the model's **Edit** menu. If the model contains invalid loops, Simulink highlights the loops

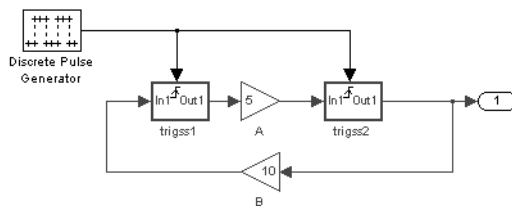

and displays an error message in the Simulation Diagnostics Viewer.

Tips for Building Models

Here are some model-building hints you might find useful:

- Memory issues

In general, the more memory, the better Simulink performs.

- Using hierarchy

More complex models often benefit from adding the hierarchy of subsystems to the model. Grouping blocks simplifies the top level of the model and can make it easier to read and understand the model. For more information, see “Creating Subsystems” on page 4-20. The Model Browser provides useful information about complex models (see “The Model Browser” on page 9-22).

- Cleaning up models

Well organized and documented models are easier to read and understand. Signal labels and model annotations can help describe what is happening in a model. For more information, see “Signal Names” on page 6-38 and “Annotating Diagrams” on page 4-16.

- Modeling strategies

If several of your models tend to use the same blocks, you might find it easier to save these blocks in a model. Then, when you build new models, just open this model and copy the commonly used blocks from it. You can create a block library by placing a collection of blocks into a system and saving the system. You can then access the system by typing its name in the MATLAB command window.

Generally, when building a model, design it first on paper, then build it using the computer. Then, when you start putting the blocks together into a model, add the blocks to the model window before adding the lines that connect them. This way, you can reduce how often you need to open block libraries.

Exploring, Searching, and Browsing Models

The following sections describe tools that enable you to quickly navigate to any point in a model and find and modify objects in a model.

The Model Explorer (p. 9-2)

How to use the Model Explorer to find, display, and modify model contents.

The Finder (p. 9-16)

How to use the Simulink Finder to locate blocks, states, and other objects in a model, using search criteria that you specify.

The Model Browser (p. 9-22)

How to navigate quickly to any point in a model's block hierarchy.

The Model Explorer

The Model Explorer allows you to quickly locate, view, and change elements of a Simulink model or Stateflow chart. To display the Model Explorer, select **Model Explorer** from the Simulink **View** menu or select an object in the block diagram and select **Explore** from its context menu. The Model Explorer appears.

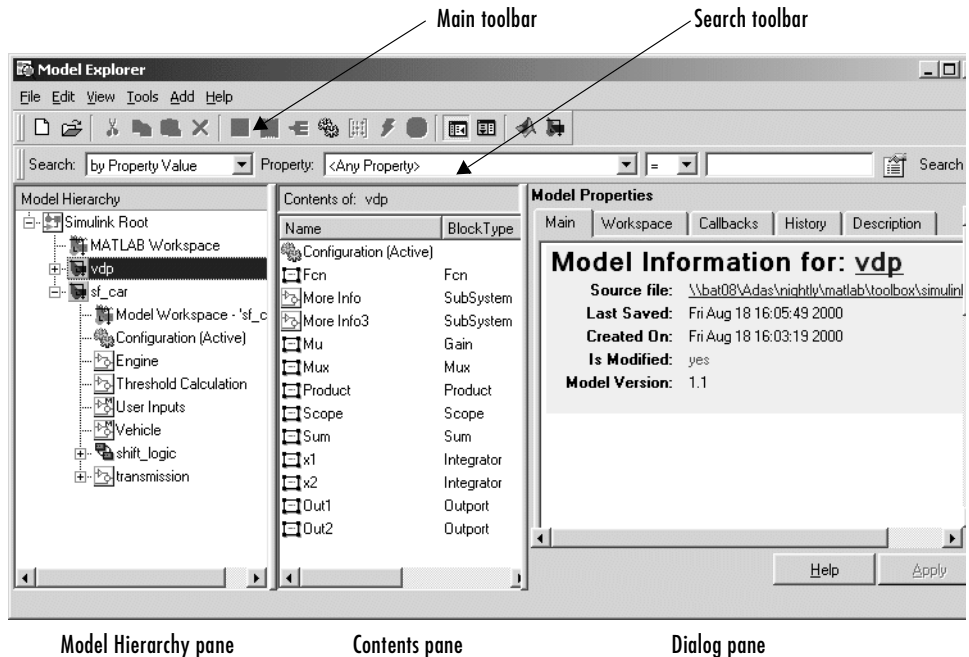

The Model Explorer includes the following components:

- **Model Hierarchy** pane (see “Model Hierarchy Pane” on page 9-3)
- **Contents** pane (see “Contents Pane” on page 9-4)
- **Dialog** pane (see “Dialog Pane” on page 9-9)
- **Main toolbar** (see “Main Toolbar” on page 9-9)
- **Search** bar (see “Search Bar” on page 9-11)

You can use the Model Explorer’s **View** menu to hide the **Dialog** pane and the toolbars, thereby making more room for the other panes.

Model Hierarchy Pane

The **Model Hierarchy** pane displays a tree-structured view of the Simulink model hierarchy.

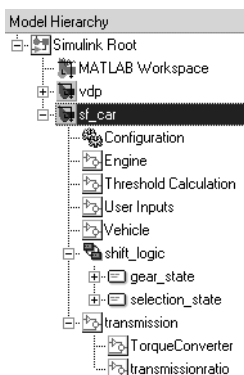

Simulink Root

The first node in the view represents the Simulink root. Expanding the root node displays nodes representing the MATLAB workspace (Simulink’s base workspace) and each model and library loaded in the current session.

Base Workspace

This node represents the MATLAB workspace. The MATLAB workspace is the base workspace for Simulink models. Variables defined in this workspace are visible to all open Simulink models, i.e., to all models whose nodes appear beneath the **Base Workspace** node in the **Model Hierarchy** pane.

Model Nodes

Expanding a model node displays nodes representing the model’s configuration sets (see “Configuration Sets” on page 10-26), top-level subsystems, model references, and Stateflow charts. Expanding a node representing a subsystem displays its subsystems, if any. Expanding a node representing a Stateflow chart displays the chart’s top-level states. Expanding a node representing a state shows its substates.

Displaying Node Contents

To display the contents of an object displayed in the **Model Hierarchy** pane (e.g., a model or configuration set) in the adjacent **Contents** pane, select the object. To open a graphical object (e.g., a model, subsystem, or chart) in an editor window, right-click the object. A context menu appears. Select **Open** from the context menu. To open an object’s properties dialog, select **Properties** from the object’s context menu or from the **Edit** menu. See “Configuration Sets” on page 10-26 for information on using the **Model Hierarchy** pane to delete, move, and copy configuration sets from one model to another.

Expanding Model References

To expand a node representing a model reference (see “Referencing Models” on page 4-53), you must first open the referenced model. To do this, right-click on the node to display its context menu, then select **Open Model** from the menu. Simulink opens the model to which the reference refers, displays a node for it in the **Model Hierarchy** pane, and make all references to the model expandable. You cannot edit the contents of a reference node, however. To edit the referenced model, you must expand its node.

Contents Pane

The **Contents** pane displays a tabular view of the contents of the object selected in the **Model Hierarchy** pane or the results of a search operation (see “Search Bar” on page 9-11).

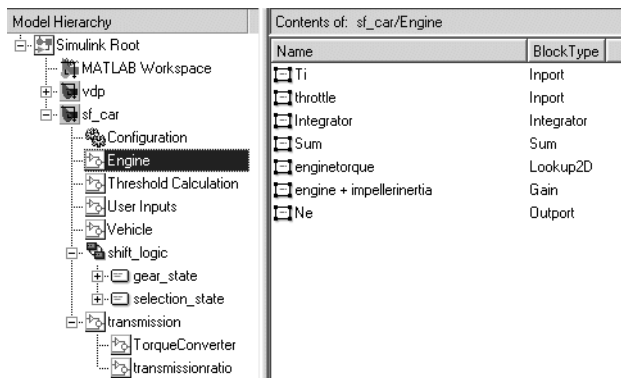

The table rows correspond to objects (e.g., blocks or states); the table columns, to object properties (e.g., name and type). The table cells display the values of the properties of the objects contained by the object selected in the **Model Hierarchy** pane.

The objects and properties displayed in the **Contents** pane depend on the type of object (e.g., subsystem, chart, or configuration set) selected in the **Model Hierarchy** pane. For example, if the object selected in the **Model Hierarchy** pane is a model or subsystem, the **Contents** pane by default displays the name and type of the top-level blocks contained by that model or subsystem. If the selected object is a Stateflow chart or state, the **Contents** pane by default shows the name, scope, and other properties of the events and data that make up the chart or state.

Customizing the Contents Pane

The Model Explorer's **View** menu allows you to control the type of objects and properties displayed in the **Contents** pane.

- To display only object names in the **Contents** pane, uncheck the **Show Properties in List View** item on the **View** menu.
- To customize the set or properties displayed in the **Contents** pane, select **Customize Contents** from the **View** menu or click the **Customize Contents** button on the Model Explorer's main toolbar (see "Main Toolbar" on page 9-9). The **Customize Contents** pane appears. Use the pane to select the properties you want the **Contents** pane to display.
- To specify the types of subsystem or chart contents displayed in the **Contents** pane, select **List View Options** from the **View** menu. A menu of object types appears. Check the types that you want to be displayed (e.g., **Blocks** and **Named Signals/Connections** or **All Simulink Objects** for models and subsystems).

Reordering the Contents Pane

The **Contents** pane by default displays its contents in ascending order by name. To order the contents in ascending order by any other displayed property, click the head of the column that displays the property. To change the order from ascending to descending, or vice versa, click the head of the property column that determines the current order.

Customize Contents Pane

The **Customize Contents** pane allows you to select the properties that the **Contents** pane displays for the object selected in the **Model Hierarchy** pane. When visible, the pane appears in the lower left corner of the Model Explorer window.

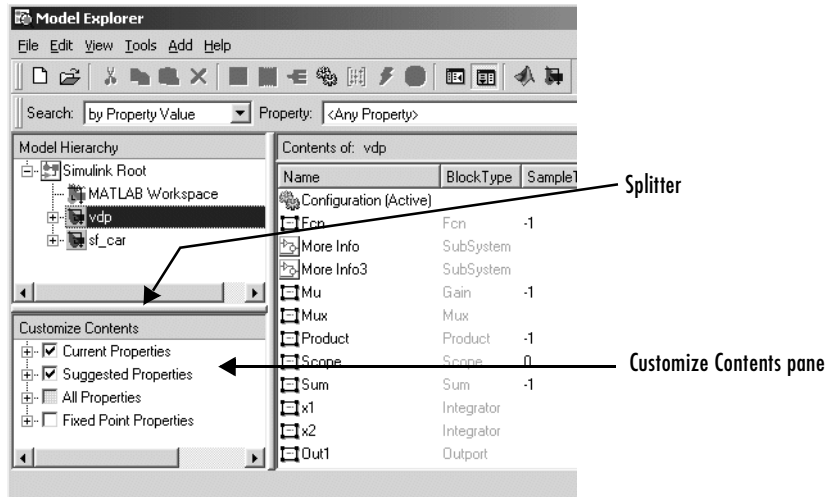

A splitter divides the **Customize Contents** pane from the **Model Hierarchy** pane above it. Drag the splitter up or down to adjust the relative size of the two panes.

The **Customize Contents** pane contains a tree-structured property list. The list's top-level nodes group object properties into the following categories:

- **Current Properties**
Properties that the **Contents** pane currently displays.
- **Suggested Properties**
Properties that Simulink suggests that the **Contents** pane should display, based on the type of object selected in the **Model Hierarchy** pane and the contents of the selected object.
- **All Properties**
Properties of the contents of all models displayed in the Model Explorer thus far in this session.

- Fixed Point Properties
Fixed-point properties of blocks.

By default, the properties currently displayed in the **Contents** pane are the suggested properties for the currently selected model. The **Customize Contents** pane allows you to perform the following customizations:

- To display additional properties of the selected model, expand the All Properties node, if necessary, and check the desired properties.
- To delete some but not all properties from the **Contents** pane, expand the Current Properties node, if necessary, and uncheck the properties that you do not want to appear in the **Contents** pane.
- To delete all properties from the **Contents** pane (except the selected object's name), uncheck Current Properties.
- To restore the properties suggested for the current model, uncheck Current Properties and check Suggested Properties.
- To add or remove fixed-point block properties from the **Contents** pane, check or uncheck Fixed Point Properties.

Marking Nonexistent Properties

Some of the properties that the Contents pane is configured to display may not apply to all the objects currently listed in the Contents pane. You can configure the Model Explorer to indicate the inapplicable properties.

To do this, select **Mark Nonexistent Properties** from the Model Explorer's **View** menu. The Model Explorer now displays dashes for the values of properties that do not apply to the objects displayed in the **Contents** pane.

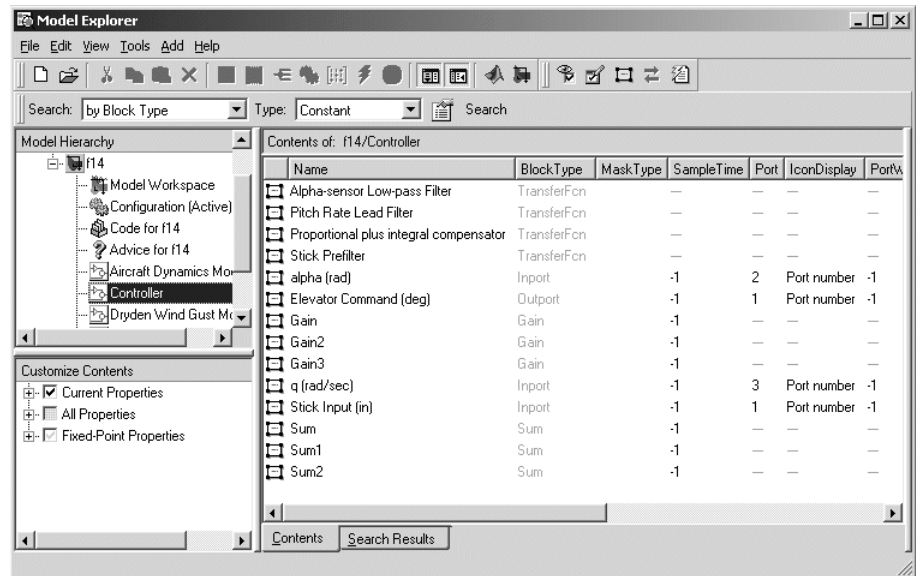

Changing Property Values

You can change modifiable properties displayed in the **Contents** pane (e.g., a block's name) by editing the displayed value. To edit a displayed value, first select the row that contains it. Then click the value. An edit control replaces the displayed value (e.g., an edit field for text values or a pull-down list for a range of values). Use the edit control to change the value of the selected property.

To assign the same property value to multiple objects displayed in the **Contents** pane, select the objects and then change one of the selected objects

to have the new property value. The Model Explorer assigns the new property value to the other selected objects as well.

Dialog Pane



The **Dialog** pane displays the dialog view of the object selected in the **Contents** pane, e.g., a block or a configuration subset. You can use the **Dialog** pane to view and change the selected object's properties. To show or hide this pane, select the **Show Dialog View** menu from the Model Explorer's **View** menu or the **Show Dialog View** button on the Model Explorer's main toolbar (see "Main Toolbar" on page 9-9).













Main Toolbar



The Model Explorer's main toolbar appears near the top of the Model Explorer window under the Model Explorer's menu.



The toolbar contains buttons that select commonly used Model Explorer commands:

Button	Usage
	Create a new model.
	Open an existing model.
	Cut the objects (e.g., variables) selected in the Contents pane from the object (e.g., a workspace) selected in the Model Hierarchy pane. Save a copy of the object on the system clipboard.

Button	Usage
	Copy the objects selected in the Contents pane to the system clipboard.
	Paste objects from the clipboard into the object selected in the Model Explorer's Model Hierarchy pane.
	Delete the objects selected in the Contents pane from the object selected in the Model Hierarchy pane.
	Add a MATLAB variable to the workspace selected in the Model Hierarchy pane.
	Add a Simulink.Parameter object to the workspace selected in the Model Hierarchy pane.
	Add a Simulink.Signal object to the workspace selected in the Model Hierarchy pane.
	Add a configuration set to the model selected in the Model Hierarchy pane.
	Add a Stateflow datum to the machine or chart selected in the Model Hierarchy pane.
	Add a Stateflow event to the machine or chart selected in the Model Hierarchy pane or to the state selected in the Model Explorer.
	Add a code generation target to the model selected in the Model Hierarchy pane.
	Turn the Model Explorer's Dialog pane on or off.
	Customize the Model Explorer's Contents pane.

Button	Usage
	Bring the MATLAB desktop to the front.
	Display the Simulink Library Browser.

To show or hide the main toolbar, select **Main Toolbar** from the Model Explorer's **View** menu.

Search Bar

The Model Explorer's search bar allows you to select, configure, and initiate searches of the object selected in the **Model Hierarchy** pane. It appears at the top of the Model Explorer window.

Search bar

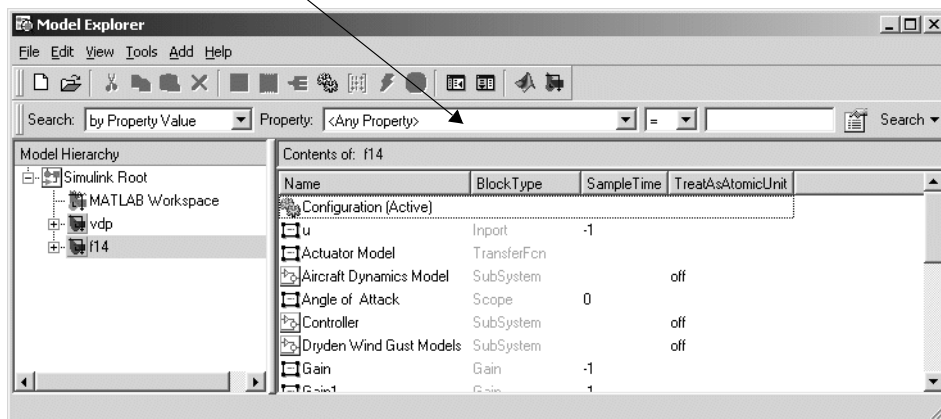

To show or hide the search bar, check or uncheck **Search Bar** in the Model Explorer's **View** menu.

The search bar includes the following controls:

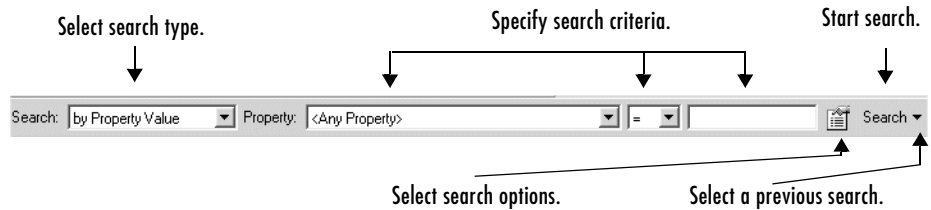

Search Type

Specifies the type of search to be performed. Options include:

- by Property Value
Search for objects whose property matches a specified value. Selecting this search type causes the search bar to display controls that allow you to specify the name of the property, the value to be matched, and the type of match (equals, less than, greater than, etc.).
- by Property Name
Search for objects that have a specified property. Selecting this search type causes the search bar to display a control that allows you to specify the target property's name by selecting from a list of properties that objects in the search domain can have.
- by Block Type
Search for blocks of a specified block type. Selecting this search type causes the search bar to display a block type list control that allows you to select the target block type from the types contained by the currently selected model.
- for Library Links
Searches for library links in the current model.
- by Class
Searches for Simulink objects of a specified class.
- for Model References
Searches a model for references to other models.
- for Fixed Point
Searches a model for all blocks that support fixed-point computations.

- by Dialog Prompt
Searches a model for all objects whose dialogs contain a specified prompt.
- by String
Searches a model for all objects in which a specified string occurs.

Search Options

Specifies options that apply to the current search. The options include:

- Search All Descendants
Search the descendants of the currently selected object as well as the selected object itself.
- Look Inside Masked Subsystems
Search includes masked subsystems.
- Look Inside Linked Subsystems
Search includes linked subsystems.
- Match Whole String
Do not allow partial string matches, e.g., do not allow sub to match substring.
- Match Case
Consider case when matching strings, e.g., Gain does not match gain.
- Regular Expression
The Model Explorer considers a string to be matched as a regular expression.
- Refine Search Uses Boolean 'AND'
When refining a search, search for objects that meet both the original and the new search criteria.
- Refine Search Uses Boolean 'OR'
When refining a search, search for objects that meet either the original or the new search criteria. (Not yet implemented.)
- Clear Search History
Not yet implemented.

Search Button

Initiates the search specified by the current settings of the search bar on the object selected in the Model Explorer's **Model Hierarchy** pane. The Model

Explorer displays the results of the search in its **Contents** pane and enters search mode.

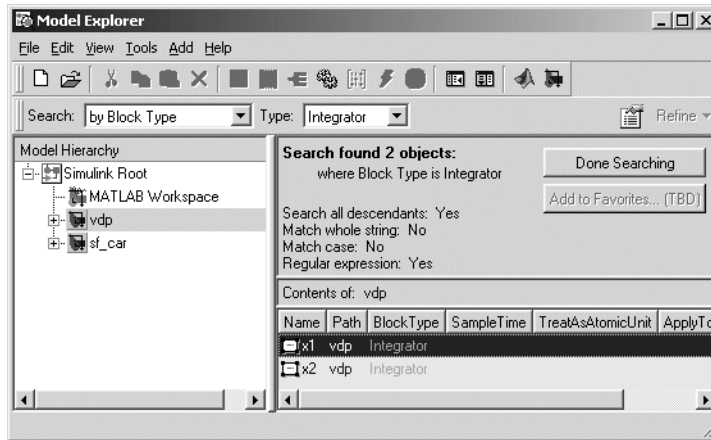

In search mode, you can perform the following tasks:

- Refine the previous search.
In search mode, a **Refine** button replaces the **Search** button on the search bar. To refine the search results, use the search bar to define new search criteria and then click the **Refine** button. The Model Explorer searches for objects that match the previous search criteria and/or the new criteria, depending on the setting of the refine search options.
- Apply the previous search to another object.
To apply the previous search to another object, select the object in the Model Explorer's **Model Hierarchy** pane. The Model Explorer repeats the search on the new object and displays the results.
- Edit search results.
In search mode, you can edit the results displayed in the **Contents** pane just as you can edit them in explore mode. For example, to change all objects found by a search to have the same property value, select the objects in the **Contents** pane and change one of them to have the new property value.

To exit search mode, click the **Done Searching** button at the top of the search results.

Search History

The down arrow control adjacent to the **Search** button displays a list of searches previously executed in the current Simulink session. To reexecute a search, select it from the history and click the **Search** button. (Note this feature is not yet implemented.)

The Finder

The Finder locates blocks, signals, states, or other objects in a model. To display the Finder, select **Find** from the **Edit** menu. The **Find** dialog box appears.

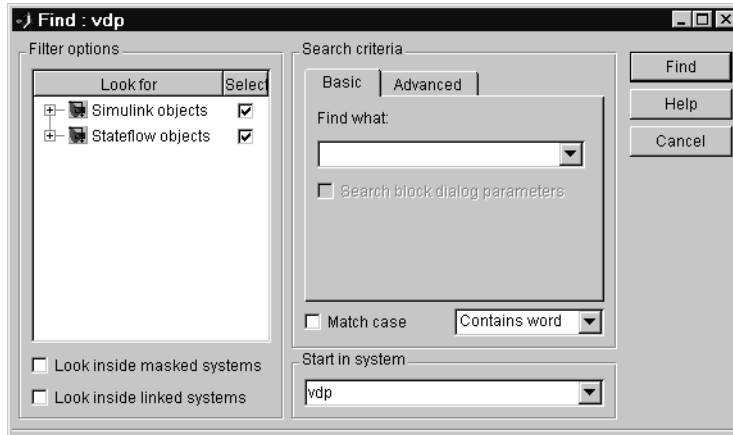

Use the **Filter options** (see “Filter Options” on page 9-18) and **Search criteria** (see “Search Criteria” on page 9-18) panels to specify the characteristics of the object you want to find. Next, if you have more than one system or subsystem open, select the system or subsystem where you want the search to begin from the **Start in system** list. Finally, click the **Find** button. Simulink searches the selected system for objects that meet the criteria you have specified.

Any objects that satisfy the criteria appear in the results panel at the bottom of the dialog box.

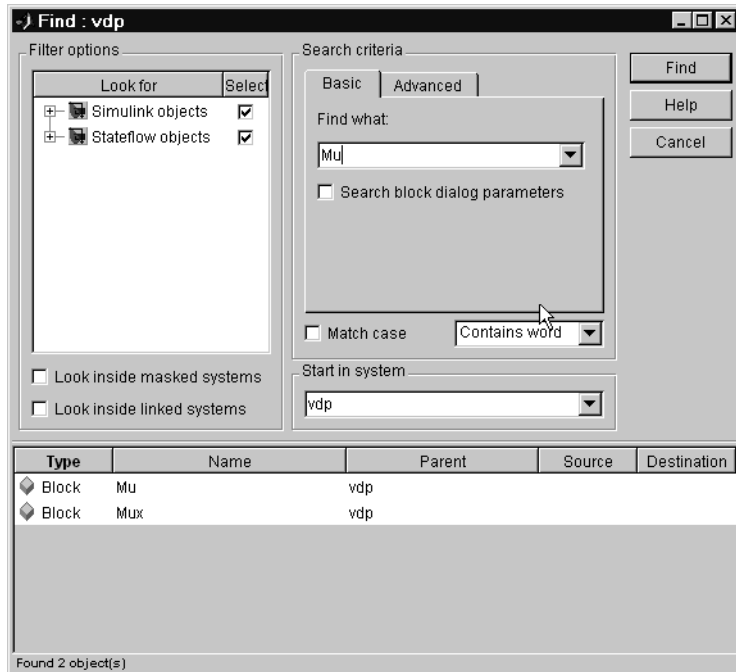

You can display an object by double-clicking its entry in the search results list. Simulink opens the system or subsystem that contains the object (if necessary) and highlights and selects the object. To sort the results list, click any of the buttons at the top of each column. For example, to sort the results by object type, click the **Type** button. Clicking a button once sorts the list in ascending order, clicking it twice sorts it in descending order. To display an object's parameters or properties, select the object in the list. Then press the right mouse button and select **Parameter** or **Properties** from the resulting context menu.

Filter Options

The **Filter options** panel allows you to specify the kinds of objects to look for and where to search for them.

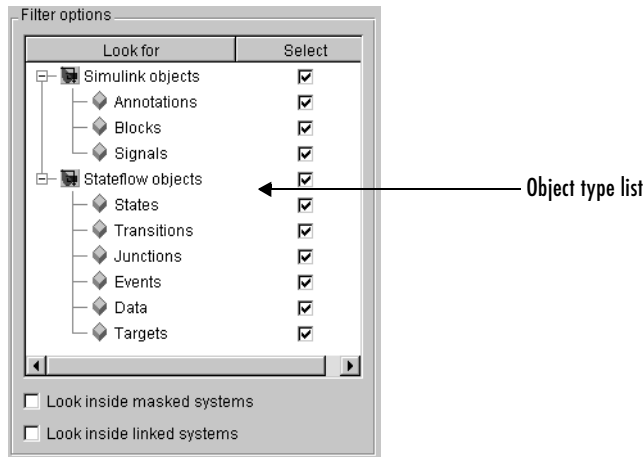

Object type list

The object type list lists the types of objects that Simulink can find. By clearing a type, you can exclude it from the Finder's search.

Look inside masked subsystem

Selecting this option causes Simulink to look for objects inside masked subsystems.

Look inside linked systems

Selecting this option causes Simulink to look for objects inside subsystems linked to libraries.

Search Criteria

The **Search criteria** panel allows you to specify the criteria that objects must meet to satisfy your search request.

Basic

The **Basic** panel allows you to search for an object whose name and, optionally, dialog parameters match a specified text string. Enter the search text in the panel's **Find what** field. To display previous search text, select the drop-down list button next to the **Find what** field. To reenter text, click it in the drop-down list. Select **Search block dialog parameters** if you want dialog parameters to be included in the search.

Advanced

The **Advanced** panel allows you to specify a set of as many as seven properties that an object must have to satisfy your search request.

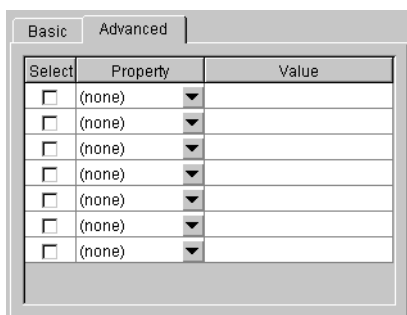

To specify a property, enter its name in one of the cells in the **Property** column of the **Advanced** pane or select the property from the cell's property list. To display the list, select the down arrow button next to the cell. Next enter the value of the property in the **Value** column next to the property name. When you enter a property name, the Finder checks the check box next to the property name in the **Select** column. This indicates that the property is to be included in the search. If you want to exclude the property, clear the check box.

Match case

Select this option if you want Simulink to consider case when matching search text against the value of an object property.

Other match options

Next to the **Match case** option is a list that specifies other match options that you can select.

- **Match whole word**
Specifies a match if the property value and the search text are identical except possibly for case.
- **Contains word**
Specifies a match if a property value includes the search text.
- **Regular expression**
Specifies that the search text should be treated as a regular expression when matched against property values. The following characters have special meanings when they appear in a regular expression.

Character	Meaning
^	Matches start of string.
\$	Matches end of string.
.	Matches any character.
\	Escape character. Causes the next character to have its ordinary meaning. For example, the regular expression \. matches .a and .2 and any other two-character string that begins with a period.
*	Matches zero or more instances of the preceding character. For example, ba* matches b, ba, baa, etc.
+	Matches one or more instances of the preceding character. For example, ba+ matches ba, baa, etc.
[]	Indicates a set of characters that can match the current character. A hyphen can be used to indicate a range of characters. For example, [a-zA-Z0-9_]+ matches foo_bar1 but not foo\$bar. A ^ indicates a match when the current character is not one of the following characters. For example, [^0-9] matches any character that is not a digit.
\w	Matches a word character (same as [a-zA-Z0-9]).
\W	Matches a nonword character (same as [^a-zA-Z0-9]).

Character	Meaning
<code>\d</code>	Matches a digit (same as <code>[0-9]</code>).
<code>\D</code>	Matches a nondigit (same as <code>[^0-9]</code>).
<code>\s</code>	Matches white space (same as <code>[\t\r\n\f]</code>).
<code>\S</code>	Matches nonwhite space (same as <code>[^\t\r\n\f]</code>).
<code>\<WORD\></code>	Matches WORD where WORD is any string of word characters surrounded by white space.

The Model Browser

The Model Browser enables you to

- Navigate a model hierarchically
- Open systems in a model
- Determine the blocks contained in a model

The browser operates differently on Microsoft Windows and UNIX platforms.

Using the Model Browser on Windows

To display the Model Browser, select **Model Browser** from the Simulink **View** menu.

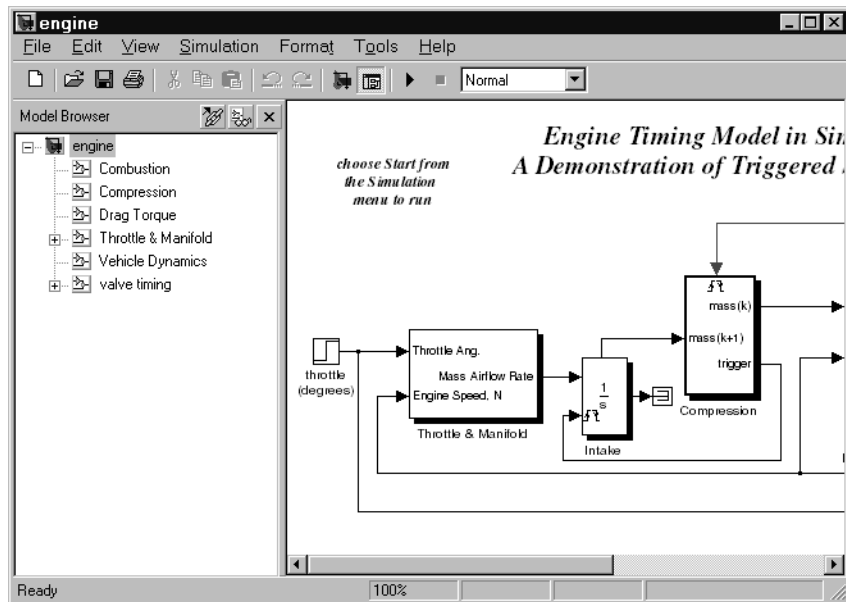

The model window splits into two panes. The left pane displays the browser, a tree-structured view of the block diagram displayed in the right pane.

Note The **Browser initially visible** preference causes Simulink to open models by default in the Model Browser. To set this preference, select **Preferences** from the Simulink **File** menu.

The top entry in the tree view corresponds to your model. A button next to the model name allows you to expand or contract the tree view. The expanded view shows the model's subsystems. A button next to a subsystem indicates that the subsystem itself contains subsystems. You can use the button to list the subsystem's children. To view the block diagram of the model or any subsystem displayed in the tree view, select the subsystem. You can use either the mouse or the keyboard to navigate quickly to any subsystem in the tree view.

Navigating with the Mouse

Click any subsystem visible in the tree view to select it. Click the + button next to any subsystem to list the subsystems that it contains. Click the button again to contract the entry.

Navigating with the Keyboard

Use the up/down arrows to move the current selection up or down the tree view. Use the left/right arrow or +/- keys on your numeric keypad to expand an entry that contains subsystems.

Showing Library Links

The Model Browser can include or omit library links from the tree view of a model. Use the Simulink **Preferences** dialog box to specify whether to display library links by default. To toggle display of library links, select **Show library links** from the **Model browser options** submenu of the Simulink **View** menu.

Showing Masked Subsystems

The Model Browser can include or omit masked subsystems from the tree view. If the tree view includes masked subsystems, selecting a masked subsystem in the tree view displays its block diagram in the diagram view. Use the Simulink **Preferences** dialog box to specify whether to display masked subsystems by default. To toggle display of masked subsystems, select **Look under masks** from the **Model browser options** submenu of the Simulink **View** menu.

Using the Model Browser on UNIX

To open the Model Browser, select **Show Browser** from the **File** menu. The Model Browser window appears, displaying information about the current model. This figure shows the Model Browser window displaying the contents of the `clutch` system.

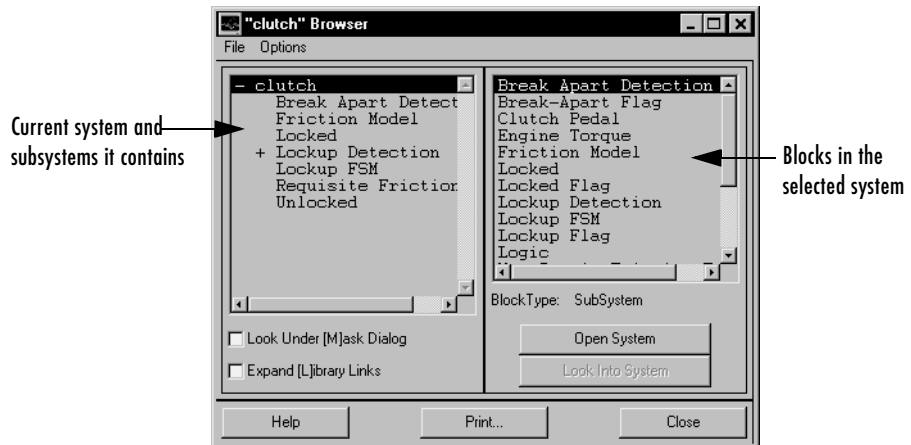

Contents of the Browser Window

The Model Browser window consists of

- The systems list. The list on the left contains the current system and the subsystems it contains, with the current system selected.
- The blocks list. The list on the right contains the names of blocks in the selected system. Initially, this window displays blocks in the top-level system.
- The **File** menu, which contains the **Print**, **Close Model**, and **Close Browser** menu items.
- The **Options** menu, which contains the menu items **Open System**, **Look Into System**, **Display Alphabetical/Hierarchical List**, **Expand All**, **Look Under Mask Dialog**, and **Expand Library Links**.
- The **Options** check boxes and buttons **Look Under [M]ask Dialog** and **Expand [L]ibrary Links** check boxes, and **Open System** and **Look Into System** buttons. By default, Simulink does not display the contents of

masked blocks and blocks that are library links. These check boxes enable you to override the default.

- The block type of the selected block.
- Dialog box buttons **Help**, **Print**, and **Close**.

Interpreting List Contents

Simulink identifies masked blocks, reference blocks, blocks with defined OpenFcn parameters, and systems that contain subsystems using these symbols before a block or system name:

- A plus sign (+) before a system name in the systems list indicates that the system is expandable, which means that it has systems beneath it. Double-click the system name to expand the list and display its contents in the blocks list. When a system is expanded, a minus sign (-) appears before its name.
- [M] indicates that the block is masked, having either a mask dialog box or a mask workspace. For more information about masking, see Chapter 12, “Creating Masked Subsystems.”
- [L] indicates that the block is a reference block. For more information, see “Connecting Blocks” on page 4-9.
- [O] indicates that an open function (OpenFcn) callback is defined for the block. For more information about block callbacks, see “Using Callback Routines” on page 4-90.
- [S] indicates that the system is a Stateflow block.

Opening a System

You can open any block or system whose name appears in the blocks list. To open a system:

- 1 In the systems list, select by single-clicking the name of the parent system that contains the system you want to open. The parent system’s contents appear in the blocks list.
- 2 Depending on whether the system is masked, linked to a library block, or has an open function callback, you open it as follows:
 - If the system has no symbol to its left, double-click its name or select its name and click the **Open System** button.

- If the system has an [M] or [O] before its name, select the system name and click the **Look Into System** button.

Looking into a Masked System or a Linked Block

By default, the Model Browser considers masked systems (identified by [M]) and linked blocks (identified by [L]) as blocks and not subsystems. If you click **Open System** while a masked system or linked block is selected, the Model Browser displays the system or block's dialog box (**Open System** works the same way as double-clicking the block in a block diagram). Similarly, if the block's `OpenFcn` callback parameter is defined, clicking **Open System** while that block is selected executes the callback function.

You can direct the Model Browser to look beyond the dialog box or callback function by selecting the block in the blocks list, then clicking **Look Into System**. The Model Browser displays the underlying system or block.

Displaying List Contents Alphabetically

By default, the systems list indicates the hierarchy of the model. Systems that contain systems are preceded with a plus sign (+). When those systems are expanded, the Model Browser displays a minus sign (-) before their names. To display systems alphabetically, select the **Display Alphabetical List** menu item on the **Options** menu.

Running Simulations

The following sections explain how to use Simulink to simulate a dynamic system.

Simulation Basics (p. 10-2)	How to start, suspend, stop, interact with, and diagnose errors in a simulation.
Specifying a Simulation Start and Stop Time (p. 10-6)	How to specify the start and stop time for a simulation.
Choosing a Solver (p. 10-7)	How to select the optimal solver for simulating a model.
Importing and Exporting Simulation Data (p. 10-16)	How to specify options for importing and exporting simulation data to the MATLAB workspace.
Configuration Sets (p. 10-26)	How to specify interchangeable sets of simulation configuration parameters for a model.
The Configuration Parameters Dialog Box (p. 10-30)	How to use the Configuration Parameters dialog box to specify a simulation configuration.
Diagnosing Simulation Errors (p. 10-72)	How to use the Simulation Diagnostics Viewer to diagnose simulation errors.
Improving Simulation Performance and Accuracy (p. 10-76)	Tips on improving simulation performance and accuracy.
Running a Simulation Programmatically (p. 10-78)	How to run a simulation from a program or the MATLAB command line.

Simulation Basics

Simulating a Simulink model requires only that you start the simulation (see “Starting a Simulation” on page 10-3). However, before starting the simulation, you may want to specify various simulation options, such as the simulation’s start and stop time and the type of solver used to solve the model at each simulation time step. Specifying simulation options is called configuring a simulation. Simulink enables you to create multiple simulation configurations, called configuration sets, for a model, modify existing configuration sets, and switch configuration sets with a click of a mouse button (see “Configuration Sets” on page 10-26 for information on creating and selecting configuration sets).

Once you have defined or selected a simulation configuration set that meets your needs, you can start the simulation. Simulink then runs the simulation from the specified start time to the specified stop time. While the simulation is running, you can interact with the simulation in various ways, stop or pause the simulation (see “Pausing or Stopping a Simulation” on page 10-4), and launch simulations of other models. If an error occurs during a simulation, Simulink halts the simulation and pops up a diagnostic viewer that helps you to determine the cause of the error.

Note The following sections explain how to run a simulation interactively. See “Running a Simulation Programmatically” on page 10-78 for information on running a simulation from a program or the MATLAB command line.

Controlling Execution of a Simulation

The Simulink graphical interface includes menu commands and toolbar buttons that enable you to start, stop, and pause a simulation.

Starting a Simulation

To start execution of a model, select **Start** from the model editor's **Simulation** menu or click the **Start** button on the model's toolbar.

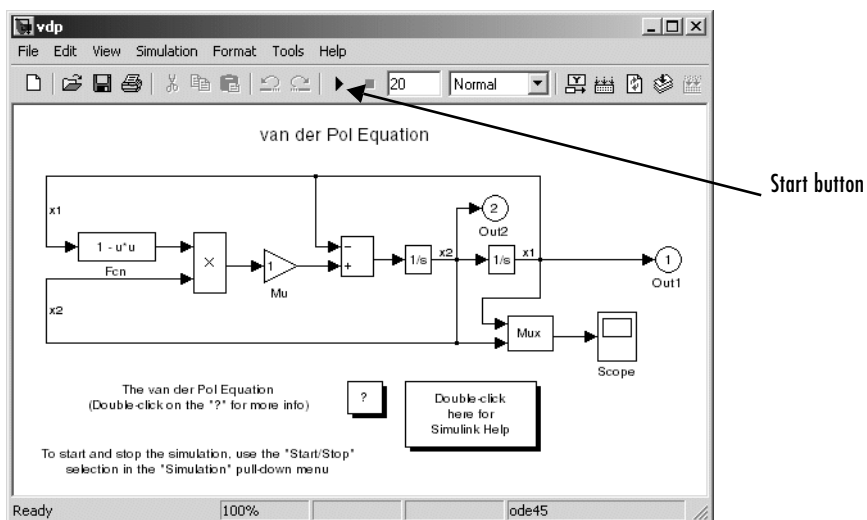

You can also use the keyboard shortcut, **Ctrl+T**, to start the simulation.

Note A common mistake that new Simulink users make is to start a simulation while the Simulink block library is the active window. Make sure your model window is the active window before starting a simulation.

Simulink starts executing the model at the start time specified on the **Configuration Parameters** dialog box. Execution continues until the simulation reaches the final time step specified on the **Configuration Parameters** dialog box, an error occurs, or you pause or terminate the simulation (see “The Configuration Parameters Dialog Box” on page 10-30).

While the simulation is running, a progress bar at the bottom of the model window shows how far the simulation has progressed. A **Stop** command replaces the **Start** command on the **Simulation** menu. A **Pause** command appears on the menu and replaces the **Start** button on the model toolbar.

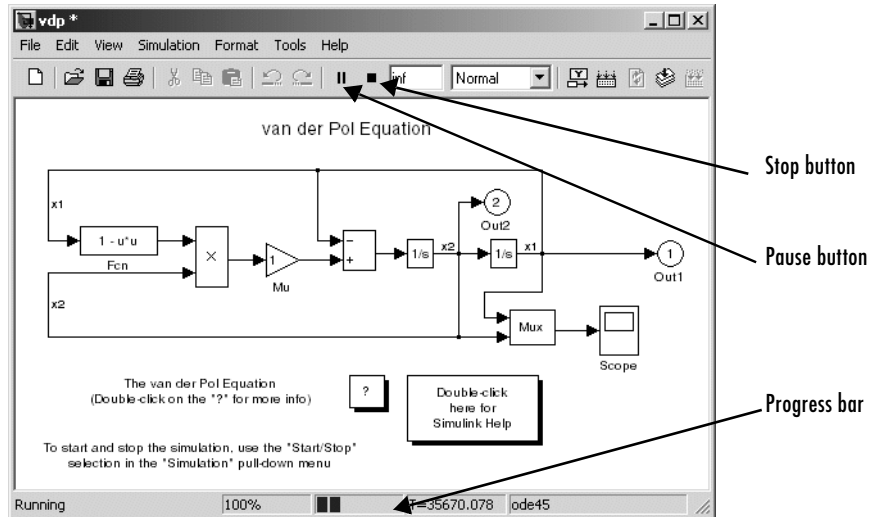

Your computer beeps to signal the completion of the simulation.

Pausing or Stopping a Simulation

Select the **Pause** command or button to pause the simulation. Simulink completes execution of the current time step and suspends execution of the simulation. When you select **Pause**, the menu item and button change to **Continue**. (The button has the same appearance as the **Start** button). You can resume a suspended simulation at the next time step by choosing **Continue**.

To terminate execution of the model, select the **Stop** command or button. The keyboard shortcut for stopping a simulation is **Ctrl+T**, the same as for starting a simulation. Simulink completes execution of the current time step before terminating the model. Subsequently selecting the **Start** command or button restarts the simulation at the first time step specified on the **Configuration Parameters** dialog box.

If the model includes any blocks that write output to a file or to the workspace, or if you select output options on the **Configuration Parameters** dialog box, Simulink writes the data when the simulation is terminated or suspended.

Interacting with a Running Simulation

You can perform certain operations interactively while a simulation is running. You can

- Modify some configuration parameters, including the stop time and the maximum step size
- Click a line to see the signal carried on that line on a floating (unconnected) Scope or Display block
- Modify the parameters of a block, as long as you do not cause a change in
 - Number of states, inputs, or outputs
 - Sample time
 - Number of zero crossings
 - Vector length of any block parameters
 - Length of the internal block work vectors

You cannot make changes to the structure of the model, such as adding or deleting lines or blocks, during a simulation. If you need to make these kinds of changes, you need to stop the simulation, make the change, then start the simulation again to see the results of the change.

Specifying a Simulation Start and Stop Time

Simulink simulations start by default at 0.0 seconds and end at 10.0 seconds. The **Solver** configuration pane allows you to specify other start and stop times for the currently selected simulation configuration. See “The Solver Pane” on page 10-31 for more information.

Note Simulation time and actual clock time are not the same. For example, running a simulation for 10 seconds usually does not take 10 seconds. The amount of time it takes to run a simulation depends on many factors, including the model’s complexity, the solver’s step sizes, and the computer’s speed.

Choosing a Solver

A solver is a Simulink software component that determines the next time step that a simulation needs to take to meet target accuracy requirements that you specify. Simulink provides an extensive set of solvers, each adept at choosing the next time step for specific types of applications. The following sections explain how to choose the solver best suited to your application. For information on tailoring the selected solver to your model, see “Improving Simulation Accuracy” on page 10-77.

Choosing a Solver Type

Simulink divides solvers into two types: fixed-step and variable-step. Both types of solvers compute the next simulation time as the sum of the current simulation time and a quantity known as the step size. With a fixed-step solver, the step size remains constant throughout the simulation. By contrast, with a variable-step solver, the step size can vary from step to step, depending on the model’s dynamics. In particular, a variable-step solver reduces the step size when a model’s states are changing rapidly to maintain accuracy and increases the step size when the system’s states are changing slowly in order to avoid taking unnecessary steps. The **Type** control on the Simulink **Solver** configuration pane allows you to select either of these two types of solvers (see “The Solver Pane” on page 10-31).

The choice between the two types depends on how you plan to deploy your model and the model’s dynamics. If you plan to generate code from your model and run the code on a real-time computer system, you should choose a fixed-step solver to simulate the model. This is because real-time computer systems operate at fixed-size signal sample rates. A variable-step solver may cause the simulation to miss error conditions that can occur on a real-time computer system.

If you do not plan to deploy your model as generated code, the choice between a variable-step and a fixed-step solver depends on the dynamics of your model. If your model’s states change rapidly or contain discontinuities, a variable-step solver can shorten the time required to simulate your model significantly. This is because, for such a model, a variable-step solver can require fewer time steps than a fixed-step solver to achieve a comparable level of accuracy.

The following model illustrates how a variable-step solver can shorten simulation time for a multirate discrete model.

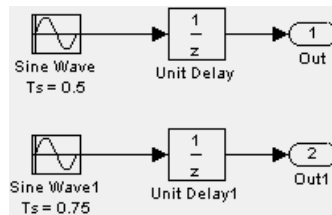

This model generates outputs at two different rates, every 0.5 second and every 0.75 second. To capture both outputs, the fixed-step solver must take a time step every 0.25 second (the *fundamental sample time* for the model).

```
[0.0 0.25 0.5 0.75 1.0 1.25 ...]
```

By contrast, the variable-step solver need take a step only when the model actually generates an output.

```
[0.0 0.5 0.75 1.0 1.5 2.0 2.25 ...]
```

This significantly reduces the number of time steps required to simulate the model.

The variable-step discrete solver uses zero-crossing detection (see “Zero-Crossing Detection” on page 2-19) to handle continuous signals. Simulink uses this solver by default if you specify a continuous solver and your model has no continuous states.

Choosing a Fixed-Step Solver

When the **Type** control of the **Solver** configuration pane is set to **fixed-step**, the configuration pane’s **Solver** control allows you to choose one of the set of fixed-step solvers that Simulink provides. The set of fixed-step solvers comprises two types of solvers: discrete and continuous.

About the Fixed-Step Discrete Solver

The fixed-step discrete solver computes the time of the next time step by adding a fixed step size to the time of the current time. The accuracy and length of time of the resulting simulation depends on the size of the steps taken by the simulation: the smaller the step size, the more accurate the results but the longer the simulation takes. You can allow Simulink to choose the size of the step size (the default) or you can choose the step size yourself. If you allow Simulink to choose the step size, Simulink sets the step size to the fundamental

sample time of the model if the model has discrete states or to the result of dividing the difference between the simulation start and stop time by 50 if the model has no discrete states. This choice assures that the simulation will hit every simulation time required to update the model's discrete states at the model's specified sample times

The fixed-step discrete solver has a fundamental limitation. It cannot be used to simulate models that have continuous states. That's because the fixed-step discrete solver relies on a model's blocks to compute the values of the states that they define. Blocks that define discrete states compute the values of those states at each time step taken by the solver. Blocks that define continuous states, on the other hand, rely on the solver to compute the states. Continuous solvers perform this task. You should thus select a continuous solver if your model contains continuous states.

Note If you attempt to use the fixed-step discrete solver to update or simulate a model that has continuous states, Simulink displays an error message. Thus, updating or simulating a model is a quick way to determine whether it has continuous states.

About Fixed-Step Continuous Solvers

Simulink provides a set of fixed-step continuous solvers that, like the fixed-step discrete solver, compute the simulation's next time by adding a fixed-size time step to the current time. In addition, the continuous solvers employ numerical integration to compute the values of a model's continuous states at the current step from the values at the previous step and the values of the state derivatives. This allows the fixed-step continuous solvers to handle models that contain both continuous and discrete states.

Note In theory, a fixed-step continuous solver can handle models that contain no continuous states. However, that would impose an unnecessary computational burden on the simulation. Consequently, Simulink always uses the fixed-step discrete solver for a model that contains no states or only discrete states, even if you specify a fixed-step continuous solver for the model.

Simulink provides two distinct types of fixed-step continuous solvers: explicit and implicit solvers. Explicit solvers (see “Explicit Fixed-Step Continuous Solvers” on page 10-10) compute the value of a state at the next time step as an explicit function of the current value of the state and the state derivative, e.g.,

$$X(n+1) = X(n) + h * DX(n)$$

where X is the state, DX is the state derivative, and h is the step size. An implicit solver (see “Implicit Fixed-Step Continuous Solvers” on page 10-11) computes the state at the next time step as an implicit function of the state and the state derivative at the next time step, e.g.,

$$X(n+1) - X(n) - h*DX(n+1) = 0$$

This type of solver requires more computation per step than an explicit solver but is also more accurate for a given step size. This solver thus can be faster than explicit fixed-step solvers for certain types of stiff systems.

Explicit Fixed-Step Continuous Solvers. Simulink provides a set of explicit fixed-step continuous solvers. The solvers differ in the specific integration technique used to compute the model’s state derivatives. The following table lists the available solvers and the integration techniques they use.

Solver	Integration Technique
ode1	Euler’s Method
ode2	Heun’s Method
ode3	Bogacki-Shampine Formula
ode4	Fourth-Order Runge-Kutta (RK4) Formula
ode5	Dormand-Prince Formula

The integration techniques used by the fixed-step continuous solvers trade accuracy for computational effort. The table lists the solvers in order of the computational complexity of the integration methods they use from least complex (ode1) to most complex (ode5).

As with the fixed-step discrete solver, the accuracy and length of time of a simulation driven by a fixed-step continuous solver depends on the size of the steps taken by the solver: the smaller the step size, the more accurate the

results but the longer the simulation takes. For any given step size, the more computationally complex the solver, the more accurate the simulation.

If you specify a fixed-step solver type for a model, Simulink sets the solver's model to `ode3`, i.e., it chooses a solver capable of handling both continuous and discrete states with moderate computational effort. As with the discrete solver, Simulink by default sets the step size to the fundamental sample time of the model if the model has discrete states or to the result of dividing the difference between the simulation start and stop time by 50 if the model has no discrete states. This assures that the solver will take a step at every simulation time required to update the model's discrete states at the model's specified sample rates. However, it does not guarantee that the default solver will accurately compute a model's continuous states or that the model cannot be simulated in less time with a less complex solver. Depending on the dynamics of your model, you may need to choose another solver and/or sample time to achieve acceptable accuracy or to shorten the simulation time.

Implicit Fixed-Step Continuous Solvers. Simulink provides one solver in this category: `ode14x`. This solver uses a combination of Newton's method and extrapolation from the current value to compute the value of a model state at the next time step. Simulink allows you to specify the number of Newton's method iterations and the extrapolation order that the solver uses to compute the next value of a model state (see "Fixed-Step Solver Options" on page 10-35). The more iterations and the higher the extrapolation order that you select, the greater the accuracy but also the greater the computational burden per step size.

Choosing a Fixed-Step Continuous Solver

Any of the fixed-step continuous solvers in Simulink can simulate a model to any desired level of accuracy, given enough time and a small enough step size. Unfortunately, in general, it is not possible, or at least not practical, to decide *a priori* which solver and step size combination will yield acceptable results for a model's continuous states in the shortest time. Determining the best solver for a particular model thus generally requires experimentation.

Here is the most efficient way to choose the best fixed-step solver for your model experimentally. First, use one of the variable-step solvers to simulate your model to the level of accuracy that you desire. This will give you an idea of what the simulation results should be. Next, use `ode1` to simulate your model at the default step size for your model. Compare the results of simulating your

model with ode1 with the results of simulating with the variable-step solver. If the results are the same within the specified level of accuracy, you have found the best fixed-step solver for your model, namely ode1. That's because ode1 is the simplest of the Simulink fixed-step solvers and hence yields the shortest simulation time for the current step size.

If ode1 does not give accurate results, repeat the preceding steps with the other fixed-step solvers until you find the one that gives accurate results with the least computational effort. The most efficient way to do this is to use a binary search technique. First, try ode3. If it gives accurate results, try ode2. If ode2 gives accurate results, it is the best solver for your model; otherwise, ode3 is the best. If ode3 does not give accurate results, try ode5. If ode5 gives accurate results, try ode4. If ode4 gives accurate results, select it as the solver for your model; otherwise, select ode5.

If ode5 does not give accurate results, reduce the simulation step size and repeat the preceding process. Continue in this way until you find a solver that solves your model accurately with the least computational effort.

Choosing a Variable-Step Solver

When the **Type** control of the **Solver** configuration pane is set to variable-step, the configuration pane's **Solver** control allows you to choose one of the set of variable-step solvers that Simulink provides. As with fixed-step solvers in Simulink, the set of variable-step solvers comprises a discrete solver and a subset of continuous solvers. Both types compute the time of the next time step by adding a step size to the time of the current time that varies depending on the rate of change of the model's states. The continuous solvers, in addition, use numerical integration to compute the values of the model's continuous states at the next time step. Both types of solvers rely on blocks that define the model's discrete states to compute the values of the discrete states that each defines.

The choice between the two types of solvers depends on whether the blocks in your model defines states and, if so, the kind of states that they define. If your model defines no states or defines only discrete states, you should select the discrete solver. In fact, if a model has no states or only discrete states, Simulink will use the discrete solver to simulate the model even if the model specifies a continuous solver.

About Variable-Step Continuous Solvers

Simulink variable-step solvers vary the step size during the simulation, reducing the step size to increase accuracy when a model's states are changing rapidly and increasing the step size to avoid taking unnecessary steps when the model's states are changing slowly. Computing the step size adds to the computational overhead at each step but can reduce the total number of steps, and hence simulation time, required to maintain a specified level of accuracy for models with rapidly changing or piecewise continuous states.

Simulink provides the following variable-step continuous solvers:

- ode45 is based on an explicit Runge-Kutta (4,5) formula, the Dormand-Prince pair. It is a *one-step* solver; that is, in computing $y(t_n)$, it needs only the solution at the immediately preceding time point, $y(t_{n-1})$. In general, ode45 is the best solver to apply as a first try for most problems. For this reason, ode45 is the default solver used by Simulink for models with continuous states.
- ode23 is also based on an explicit Runge-Kutta (2,3) pair of Bogacki and Shampine. It can be more efficient than ode45 at crude tolerances and in the presence of mild stiffness. ode23 is a one-step solver.
- ode113 is a variable-order Adams-Bashforth-Moulton PECE solver. It can be more efficient than ode45 at stringent tolerances. ode113 is a *multistep* solver; that is, it normally needs the solutions at several preceding time points to compute the current solution.
- ode15s is a variable-order solver based on the numerical differentiation formulas (NDFs). These are related to but are more efficient than the backward differentiation formulas, BDFs (also known as Gear's method). Like ode113, ode15s is a multistep method solver. If you suspect that a problem is stiff, or if ode45 failed or was very inefficient, try ode15s.
- ode23s is based on a modified Rosenbrock formula of order 2. Because it is a one-step solver, it can be more efficient than ode15s at crude tolerances. It can solve some kinds of stiff problems for which ode15s is not effective.
- ode23t is an implementation of the trapezoidal rule using a "free" interpolant. Use this solver if the problem is only moderately stiff and you need a solution without numerical damping.
- ode23tb is an implementation of TR-BDF2, an implicit Runge-Kutta formula with a first stage that is a trapezoidal rule step and a second stage that is a backward differentiation formula of order two. By construction, the same

iteration matrix is used in evaluating both stages. Like `ode23s`, this solver can be more efficient than `ode15s` at crude tolerances.

Note For a *stiff* problem, solutions can change on a time scale that is very short compared to the interval of integration, but the solution of interest changes on a much longer time scale. Methods not designed for stiff problems are ineffective on intervals where the solution changes slowly because they use time steps small enough to resolve the fastest possible change. Jacobian matrices are generated numerically for `ode15s` and `ode23s`. For more information, see Shampine, L. F., *Numerical Solution of Ordinary Differential Equations*, Chapman & Hall, 1994.

Specifying Variable-Step Solver Error Tolerances

The solvers use standard local error control techniques to monitor the error at each time step. During each time step, the solvers compute the state values at the end of the step and also determine the *local error*, the estimated error of these state values. They then compare the local error to the *acceptable error*, which is a function of the relative tolerance (*rtol*) and absolute tolerance (*atol*). If the error is greater than the acceptable error for *any* state, the solver reduces the step size and tries again:

- *Relative tolerance* measures the error relative to the size of each state. The relative tolerance represents a percentage of the state's value. The default, $1e-3$, means that the computed state is accurate to within 0.1%.
- *Absolute tolerance* is a threshold error value. This tolerance represents the acceptable error as the value of the measured state approaches zero.

The error for the i th state, e_i , is required to satisfy

$$e_i \leq \max(\text{rtol} \times |x_i|, \text{atol}_i)$$

The following figure shows a plot of a state and the regions in which the acceptable error is determined by the relative tolerance and the absolute tolerance.

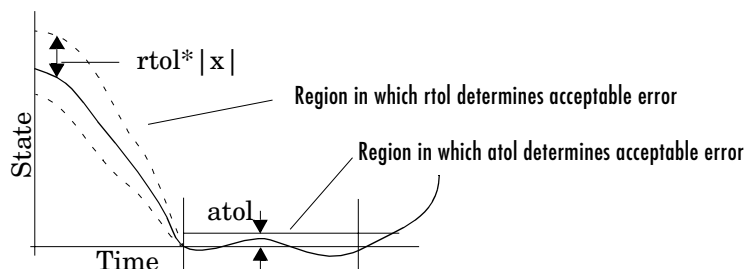

If you specify auto (the default), Simulink sets the absolute tolerance for each state initially to $1e-6$. As the simulation progresses, Simulink resets the absolute tolerance for each state to the maximum value that the state has assumed thus far times the relative tolerance for that state. Thus, if a state goes from 0 to 1 and `reltol` is $1e-3$, then by the end of the simulation the `abstol` is set to $1e-3$ also. If a state goes from 0 to 1000, then the `abstol` is set to 1.

If the computed setting is not suitable, you can determine an appropriate setting yourself. You might have to run a simulation more than once to determine an appropriate value for the absolute tolerance.

The Integrator, Transfer Fcn, State-Space, and Zero-Pole blocks allow you to specify absolute tolerance values for solving the model states that they compute or that determine their output. The absolute tolerance values that you specify for these blocks override the global settings in the **Configuration Parameters** dialog box. You might want to override the global setting in this way, if the global setting does not provide sufficient error control for all of your model's states, for example, because they vary widely in magnitude.

Importing and Exporting Simulation Data

Simulink allows you to import input signal and initial state data from the MATLAB workspace and export output signal and state data to the MATLAB workspace during simulation. This capability allows you to use standard or custom MATLAB functions to generate a simulated system's input signals and to graph, analyze, or otherwise postprocess the system's outputs. See the following sections for more information:

- “Importing Input Data from the MATLAB Workspace” on page 10-16
- “Exporting Output Data to the MATLAB Workspace” on page 10-20
- “Importing and Exporting States” on page 10-22

Importing Input Data from the MATLAB Workspace

Simulink can apply input from a model's base workspace to the model's top-level inports during a simulation run. To specify this option, select the **Input** box in the **Load from workspace** area of the **Data Import/Export** pane (see “Data Import/Export Pane” on page 10-39). Then, enter an external input specification (see below) in the adjacent edit box and click **Apply**.

The input data can take any of the following forms.

Importing Data Arrays

To use this format, select **Input** in the **Load from workspace** pane and select the Array option from the **Format** list on the **Data Import/Export** pane. Selecting this option causes Simulink to evaluate the expression next to the **Input** check box and use the result as the input to the model.

The expression must evaluate to a real (noncomplex) matrix of data type double. The first column of the matrix must be a vector of times in ascending order. The remaining columns specify input values. In particular, each column represents the input for a different Inport block signal (in sequential order) and each row is the input value for the corresponding time point. Simulink linearly interpolates or extrapolates input values as necessary if the **Interpolate data** option is selected for the corresponding Inport.

The total number of columns of the input matrix must equal $n + 1$, where n is the total number of signals entering the model's inports.

The default input expression for a model is `[t,u]` and the default input format is `Array`. So if you define `t` and `u` in the base workspace, you need only select the **Input** option to input data from the model's base workspace. For example, suppose that a model has two inports, one of which accepts two signals and the other of which accepts one signal. Also, suppose that the base workspace defines `u` and `t` as follows:

```
t = (0:0.1:1)';  
u = [sin(t), cos(t), 4*cos(t)];
```

Note The array input format allows you to load only real (noncomplex) scalar or vector data of type `double`. Use the structure format to input complex data, matrix (2-D) data, and/or data types other than `double`.

Using a MATLAB Time Expression to Import Data

You can use a MATLAB time expression to import data from the MATLAB workspace. To use a time expression, enter the expression as a string (i.e., enclosed in single quotes) in the **Input** field of the **Data Import/Export** pane. The time expression can be any MATLAB expression that evaluates to a row vector equal in length to the number of signals entering the model's inports. For example, suppose that a model has one vector Inport that accepts two signals. Furthermore, suppose that `timefcn` is a user-defined function that returns a row vector two elements long. The following are valid input time expressions for such a model:

```
'[3*sin(t), cos(2*t)]'
```

```
'4*timefcn(w*t)+7'
```

Simulink evaluates the expression at each step of the simulation, applying the resulting values to the model's inports. Note that Simulink defines the variable `t` when it runs the simulation. Also, you can omit the time variable in expressions for functions of one variable. For example, Simulink interprets the expression `sin` as `sin(t)`.

Importing Data Structures

Simulink can read data from the workspace in the form of a structure whose name is specified in the **Input** text field. You can import structures that include only signal data or both signal and time data.

Importing signal-and-time data structures. To import structures that include both signal and time data, select the Structure with time option on from the **Format** list on the **Data Import/Export** pane. The input structure must have two top-level fields: `time` and `signals`. The `time` field contains a column vector of the simulation times. The `signals` field contains an array of substructures, each of which corresponds to a model input port.

Each `signals` substructure must contain two fields named `values` and `dimensions`, respectively. The `values` field must contain an array of inputs for the corresponding input port where each input corresponds to a time point specified by the `time` field. The `dimensions` field specifies the dimensions of the input. If each input is a scalar or vector (1-D array) value, the `dimensions` field must be a scalar value that specifies the length of the vector (1 for a scalar). If each input is a matrix (2-D array), the `dimensions` field must be a two-element vector whose first element specifies the number of rows in the matrix and whose second element specifies the number of columns.

Note You must set the **Port dimensions** parameter of the Inport to be the same value as the `dimensions` field of the corresponding input structure. If the values differ, Simulink stops and displays an error message when you try to simulate the model.

If the inputs for a port are scalar or vector values, the `values` field must be an M-by-N array where M is the number of time points specified by the `time` field and N is the length of each vector value. For example, the following code creates an input structure for loading 11 time samples of a two-element signal vector of type `int8` into a model with a single input port:

```
a.time = (0:0.1:1)';  
c1 = int8([0:1:10]');  
c2 = int8([0:10:100]');  
a.signals(1).values = [c1 c2];  
a.signals(1).dimensions = 2;
```

To load this data into the model's inport, you would select the **Input** option on the **Data Import/Export** pane and enter `a` in the input expression field.

If the inputs for a port are matrices (2-D arrays), the values field must be an `M-by-N-by-T` array where `M` and `N` are the dimensions of each matrix input and `T` is the number of time points. For example, suppose that you want to input 51 time samples of a 4-by-5 matrix signal into one of your model's input ports. Then, the corresponding dimensions field of the workspace structure must equal `[4 5]` and the values array must have the dimensions 4-by-5-by-51.

As another example, consider the following model, which has two inputs.

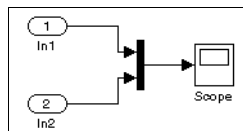

Suppose that you want to input a sine wave into the first port and a cosine wave into the second port. To do this, define a vector, `a`, as follows, in the base workspace:

```
a.time = (0:0.1:1)';
a.signals(1).values = sin(a.time);
a.signals(1).dimensions = 1;
a.signals(2).values = cos(a.time);
a.signals(2).dimensions = 1;
```

Select the **Input** box for this model, enter `a` in the adjacent text field, and select `StructureWithTime` as the I/O format.

Importing Signal-Only Structures. The Structure format is the same as the Structure with time format except that the time field is empty. For example, in the preceding example, you could set the time field as follows:

```
a.time = []
```

In this case, Simulink reads the input for the first time step from the first element of an inport's value array, the value for the second time step from the second element of the value array, etc.

Per-Port Structures. This format consists of a separate structure-with-time or structure-without-time for each port. Each port's input data structure has only one `signals` field. To specify this option, enter the names of the structures in

the **Input** text field as a comma-separated list, in_1, in_2, \dots, in_N , where in_1 is the data for your model's first port, in_2 for the second inport, and so on.

Exporting Output Data to the MATLAB Workspace

You can specify return variables by selecting the **Time**, **States**, and/or **Output** check boxes in the **Save to workspace** area of this dialog box pane. Specifying return variables causes Simulink to write values for the time, state, and output trajectories (as many as are selected) into the workspace.

To assign values to different variables, specify those variable names in the fields to the right of the check boxes. To write output to more than one variable, specify the variable names in a comma-separated list. Simulink saves the simulation times in the vector specified in the **Save to workspace** area.

Note Simulink saves the output to the workspace at the base sample rate of the model. Use a To Workspace block if you want to save output at a different sample rate.

The **Save options** area enables you to specify the format and restrict the amount of output saved.

Format options for model states and outputs are listed below.

Array. If you select this option, Simulink saves a model's states and outputs in a state and output array, respectively.

The state matrix has the name specified in the **Save to workspace** area (for example, x_{out}). Each row of the state matrix corresponds to a time sample of the model's states. Each column corresponds to an element of a state. For example, suppose that your model has two continuous states, each of which is a two-element vector. Then the first two elements of each row of the state matrix contains a time sample of the first state vector. The last two elements of each row contain a time sample of the second state vector.

The model output matrix has the name specified in the **Save to workspace** area (for example, y_{out}). Each column corresponds to a model output, each row to the outputs at a specific time.

Note You can use array format to save your model's outputs and states only if the outputs are either all scalars or all vectors (or all matrices for states), are either all real or all complex, and are all of the same data type. Use the Structure or StructureWithTime output formats (see the following) if your model's outputs and states do not meet these conditions.

Structure with time. If you select this format, Simulink saves the model's states and outputs in structures having the names specified in the **Save to workspace** area (for example, xout and yout).

The structure used to save outputs has two top-level fields: `time` and `signals`. The `time` field contains a vector of the simulation times. The `signals` field contains an array of substructures, each of which corresponds to a model output. Each substructure has four fields: `values`, `dimensions`, `label`, and `blockName`. The `values` field contains the outputs for the corresponding output. If the outputs are scalars or vectors, the `values` field is a matrix each of whose rows represents an output at the time specified by the corresponding element of the time vector. If the outputs are matrix (2-D) values, the `values` field is a 3-D array of dimensions M -by- N -by- T where M -by- N is the dimensions of the output signal and T is the number of output samples. If $T = 1$, MATLAB drops the last dimension. Therefore, the `values` field is an M -by- N matrix. The `dimensions` field specifies the dimensions of the output signal. The `label` field specifies the label of the signal connected to the output or the type of state (continuous or discrete). The `blockName` field specifies the name of the corresponding output or block with states.

The structure used to save states has a similar organization. The states structure has two top-level fields: `time` and `signals`. The `time` field contains a vector of the simulation times. The `signals` field contains an array of substructures, each of which corresponds to one of the model's states. Each signals structure has four fields: `values`, `dimensions`, `label`, and `blockName`. The `values` field contains time samples of a state of the block specified by the `blockName` field. The `label` field for built-in blocks indicates the type of state: either `CSTATE` (continuous state) or `DSTATE` (discrete state). For S-Function blocks, the label contains whatever name is assigned to the state by the S-Function block.

The time samples of a state are stored in the `values` field as a matrix of values. Each row corresponds to a time sample. Each element of a row corresponds to an element of the state. If the state is a matrix, the matrix is stored in the `values` array in column-major order. For example, suppose that the model includes a 2-by-2 matrix state and that Simulink logs 51 samples of the state during a simulation run. The `values` field for this state would contain a 51-by-4 matrix where each row corresponds to a time sample of the state and where the first two elements of each row correspond to the first column of the sample and the last two elements correspond to the second column of the sample.

Simulink can read back simulation data saved to the workspace in the `Structure with time output format`. See “Importing signal-and-time data structures” on page 10-18 for more information.

Structure. This format is the same as the preceding except that Simulink does not store simulation times in the `time` field of the saved structure.

Per-Port Structures. This format consists of a separate structure-with-time or structure-without-time for each output port. Each output data structure has only one `signals` field. To specify this option, enter the names of the structures in the **Output** text field as a comma-separated list, `out1, out2, ..., outN`, where `out1` is the data for your model’s first port, `out2` for the second inport, and so on.

Importing and Exporting States

Initial conditions, which are applied to the system at the start of the simulation, are generally set in the blocks. You can override initial conditions set in the blocks by specifying them in the **Initial state** field of the **Load from workspace** area of the **Data Import/Export** pane.

You can also save the final states for the current simulation run and apply them to a subsequent simulation run. This feature can be useful when you want to save a steady-state solution and restart the simulation at that known state. The states are saved in the format that you select in the **Save options** area of the **Data Import/Export** pane.

Saving Final States

To save the final states (the values of the states at the termination of the simulation), select the **Final states** check box and enter a variable in the adjacent edit field.

Loading Initial States

To load states, select the **Initial state** check box and specify the name of a variable that contains the initial state values. This variable can be a matrix or a structure of the same form as is used to save final states. This allows Simulink to set the initial states for the current session to the final states saved in a previous session, using the `Structure` or `Structure with time` format.

Model Reference Limitations On Loading Initial States. Simulink imposes the following limitations on loading the states of models that reference other models or that are referenced by other models.

- You cannot initialize the states of a referenced model from the workspace. Simulink ignores the **Initial state** setting for such models.
- You can use the array format to initialize the states of a top model only if the models that the top model references do not themselves have states.
- You can use the structure format to initialize the states of a top model but not those of the models that it references.

Limiting Output

Saving data to the workspace can slow down the simulation and consume memory. To avoid this, you can limit the number of samples saved to the most recent samples or you can skip samples by applying a decimation factor. To set a limit on the number of data samples saved, select the check box labeled **Limit data points to last** and specify the number of samples to save. To apply a decimation factor, enter a value in the field to the right of the **Decimation** label. For example, a value of 2 saves every other point generated.

Specifying Output Options

The **Output options** list on the **Data Import/Export** configuration pane (“Data Import/Export Pane” on page 10-39) enables you to control how much output the simulation generates. You can choose from three options:

- Refine output

- Produce additional output
- Produce specified output only

Refining Output

The `Refine` output choice provides additional output points when the simulation output is too coarse. This parameter provides an integer number of output points between time steps; for example, a refine factor of 2 provides output midway between the time steps, as well as at the steps. The default refine factor is 1.

To get smoother output, it is much faster to change the refine factor instead of reducing the step size. When the refine factor is changed, the solvers generate additional points by evaluating a continuous extension formula at those points. Changing the refine factor does not change the steps used by the solver.

The refine factor applies to variable-step solvers and is most useful when you are using `ode45`. The `ode45` solver is capable of taking large steps; when graphing simulation output, you might find that output from this solver is not sufficiently smooth. If this is the case, run the simulation again with a larger refine factor. A value of 4 should provide much smoother results.

Note This option does not help the solver to locate zero crossings (see “Zero-Crossing Detection” on page 2-19).

Producing Additional Output

The `Produce additional output` choice enables you to specify directly those additional times at which the solver generates output. When you select this option, Simulink displays an **Output times** field on the **Data Import/Export** pane. Enter a MATLAB expression in this field that evaluates to an additional time or a vector of additional times. The additional output is produced using a continuous extension formula at the additional times. Unlike the refine factor, this option changes the simulation step size so that time steps coincide with the times that you have specified for additional output.

Producing Specified Output Only

The `Produce specified output only` choice provides simulation output *only* at the specified output times. This option changes the simulation step size so

that time steps coincide with the times that you have specified for producing output. This choice is useful when you are comparing different simulations to ensure that the simulations produce output at the same times.

Comparing Output Options

A sample simulation generates output at these times:

0, 2.5, 5, 8.5, 10

Choosing `Refine` output and specifying a refine factor of 2 generates output at these times:

0, 1.25, 2.5, 3.75, 5, 6.75, 8.5, 9.25, 10

Choosing the `Produce additional` output option and specifying `[0:10]` generates output at these times

0, 1, 2, 3, 4, 5, 6, 7, 8, 9, 10

and perhaps at additional times, depending on the step size chosen by the variable-step solver.

Choosing the `Produce specified output only` option and specifying `[0:10]` generates output at these times:

0, 1, 2, 3, 4, 5, 6, 7, 8, 9, 10

In general, you should specify output points as integers times a fundamental step size. For example,

`[1:100]*0.01`

is more accurate than

`[1:0.01:100]`

Configuration Sets

A configuration set is a named set of values for a model's parameters, such as solver type and simulation start or stop time. Every new model is created with a default configuration set, called Configuration, that initially specifies default values for the model's parameters. You can subsequently create and modify additional configuration sets and associate them with the model. The sets associated with a model can each specify different values for any given model parameter.

The Active Set

Only one of the configuration sets associated with a model is active at any given time. The active set determines the current values of the model's model parameters. Changing the value of a parameter in the Model Explorer changes its value in the active set. Simulink allows you to change the active set at any time (except when executing the model). In this way, you can quickly reconfigure a model for different purposes, e.g., testing and production, or apply standard configuration settings to new models.

To determine the configuration sets associated with a model, open the Model Explorer (see "The Model Explorer" on page 9-2). The configuration sets associated with the model appear as gear-shaped nodes in the Model Explorer's **Model Hierarchy** pane.

Activating a Configuration Set

To activate a configuration set, right-click the configuration set's node to display the node's context menu, then select **Activate** from the context menu.

Copying and Moving Configuration Sets

You can copy or move a configuration set by dragging its node and dropping it on any model node in the **Model Hierarchy** pane. To move a configuration set from one model to another, hold the **Ctrl** key and the left mouse button down and drag the configuration set's node to the node of the destination model; to copy a configuration, hold the **Ctrl** key and the right mouse button down and drag the configuration set's node to the node of the same or a different model.

Creating Configuration Sets

To create a new configuration set, copy an existing configuration set.

Setting Values in Configuration Sets

To set the value of a parameter in a configuration set, select the configuration set in the Model Explorer and then edit the value of the parameter on the corresponding dialog in the Model Explorer's dialog view.

Configuration Set API

Simulink provides an application program interface (API) that permits you to create and manipulate configuration sets from the command line or in a MAT-file or M-file. For example, to create a configuration set from scratch at the command line, enter

```
cfg_set = Simulink.ConfigSet('name')
```

where **name** is the name of the new configuration set. Use `get_param` and `set_param` to get and set the value of a parameter in a configuration set. For example, to specify the Simulink fixed-step discrete solver in the configuration set, execute

```
set_param(cfg_set, 'Solver', 'FixedStepDiscrete')
```

To save the configuration set in a MAT-file, execute

```
save mat_file cfg_set
```

where **mat_file** is the name of the MAT-file. To load the configuration set, execute

```
load mat_file
```

To prevent or allow a user to change the value of a parameter in a configuration set, execute

```
setPropEnabled(cfg_set, 'param', [0 | 1])
```

where **param** is the name of the parameter. To attach a configuration set to a model, execute

```
attachConfigSet(model, cfg_set)
```

where `model` is the model name (in quotes) or object. To get a model's active configuration set, execute

```
cfg_set = getActiveConfigSet(model)
```

To get a configuration set's full name (e.g., `engine/Configuration`), execute

```
getFullName(cfg_set)
```

To set a model's active set, execute

```
setActiveConfigSet(model, cfg_set)
```

where `cfg_set` is the configuration set's name in quotes.

The Model Configuration Dialog Box

The Model Configuration dialog box appears when you select a model configuration in the Model Explorer.

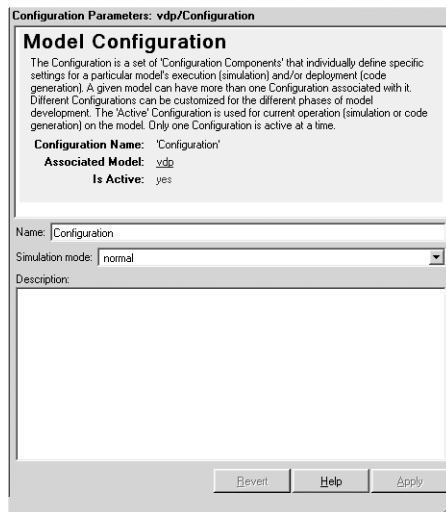

The dialog box has the following fields.

Name

Name of the configuration. You can change the name of the configuration by editing this field.

Simulation mode

The simulation mode used to simulate the model in this configuration. The options are normal (“Simulation Basics” on page 10-2), accelerator (see “The Simulink Accelerator” on page 14-2), or external mode (see the Real-Time Workshop documentation).

Description

A description of this configuration. You can use this field to enter information pertinent to using this configuration.

The Configuration Parameters Dialog Box

The **Configuration Parameters** dialog box allows you to modify settings for a model's active configuration set (see “Configuration Sets” on page 10-26).

Note You can also use the Model Explorer to modify settings for the active configuration set as well as for any other configuration set. See “The Model Explorer” on page 9-2 for more information.

To display the dialog box, select **Configuration Parameters** from the model editor's **Simulation** or context menu. The dialog box appears.

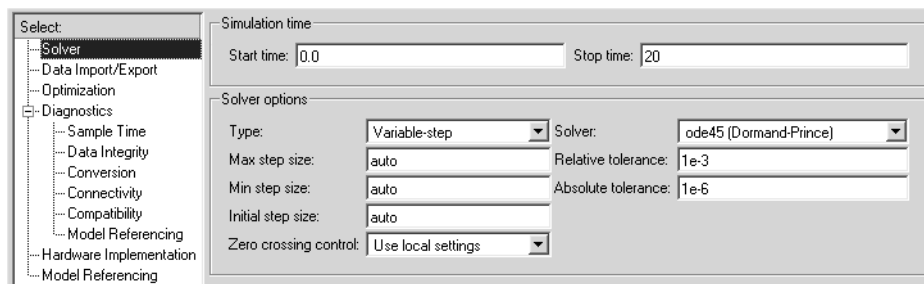

The dialog box groups the controls used to set the configuration parameters into various categories. To display the controls for a specific category, click the category in the **Select** tree on the left side of the dialog box. See the following sections for information on how to use the various categories of controls to set configuration parameters for the active configuration set.

- “The Solver Pane” on page 10-31
- “Data Import/Export Pane” on page 10-39
- “The Optimization Pane” on page 10-43
- “The Diagnostics Pane” on page 10-48
- “Hardware Implementation Pane” on page 10-63
- “Model Referencing Pane” on page 10-67

In most cases, Simulink does not immediately apply a change that you have made with a control. To apply a change, you must click either the **OK** or the

Apply button at the bottom of the dialog box. The **OK** button applies all the changes you made and dismisses the dialog box. The **Apply** button applies the changes but leaves the dialog box open so that you can continue to make changes.

Note Each of the controls on the **Configuration Parameters** dialog box correspond to a configuration parameter that you can set via the `sim` and `simset` commands. The “Model Parameters” subsection of the “Model and Block Parameters” section of the Simulink Reference documentation lists these parameters. This section also specifies for each configuration parameter the **Configuration Parameters** dialog box prompt of the control that sets it. This allows you to determine the model parameter corresponding to a control on the **Configuration Parameters** dialog box.

The Solver Pane

The **Solver** configuration parameters pane allows you to specify a simulation start and stop time and select and configure a solver for a particular simulation configuration.

Simulation time	
Start time:	0.0
Stop time:	20

Solver options	
Type:	Variable-step
Max step size:	auto
Min step size:	auto
Initial step size:	auto
Zero crossing control:	Use local settings
Solver:	ode45 (Dormand-Prince)
Relative tolerance:	1e-3
Absolute tolerance:	1e-6

The **Solver** pane contains the following control groups.

Simulation time

This control group enables you to specify the simulation start and stop time. It contains the following controls.

Start time. Specifies the simulation start time. The default start time is 0.0 seconds.

Stop time. Specifies the simulation stop time. The default stop time is 10.0 seconds. Specify `inf` to cause the simulation to run until you pause or stop it.

Simulation time and actual clock time are not the same. For example, running a simulation for 10 seconds usually does not take 10 seconds. The amount of time it takes to run a simulation depends on many factors, including the model's complexity, the solver's step sizes, and the computer's speed.

Solver Options

The **Solver options** controls group allows you to specify the type of solver to be used and simulation options specific to that solver.

The contents of the group depends on the solver type.

General Solver Options

The follow options always appear.

Type. Specifies the type of solver to be used to solve the currently selected model, either `Fixed-step` or `Variable-step`. See “Choosing a Solver Type” on page 10-7 and “Improving Simulation Performance and Accuracy” on page 10-76 for information on how to choose the solver type that best suits your application.

Solver. Specifies the solver used to simulate this configuration of the current model. The associated pull-down list displays available solvers of the type specified by the **Type** control. To specify another solver of the specified type, select the solver from the pull-down list. See “Choosing a Fixed-Step Solver” on page 10-8 and “Choosing a Variable-Step Solver” on page 10-12 for information on how to choose the solvers listed in the **Solver** list.

The other controls that appear in this group depend on the type of solver you have selected.

Variable-Step Discrete Solver Options

The following options appear when you select the Simulink variable-step discrete solver.



Max step size. Appears only if the solver **Type** is Variable-step. Specifies the largest time step the selected variable-step solver can take. The default auto causes Simulink to choose the model’s shortest sample time as the maximum step size.

Zero crossing control. Enables zero-crossing detection during variable-step simulation of the model. For most models, this speeds up simulation by enabling the solver to take larger time steps. If a model has extreme dynamic changes, disabling this option can speed up the simulation but can also decrease the accuracy of simulation results. See “Zero-Crossing Detection” on page 2-19 for more information.

You can override this optimization on a block-by-block basis for the following types of blocks:

Abs	Integrator	Step
Backlash	MinMax	Switch
Dead Zone	Relay	Switch Case
Enable	Relational Operator	Trigger
Hit Crossing	Saturation	
If	Sign	

To override zero-crossing detection for an instance of one of these blocks, open the block’s parameter dialog box and uncheck the **Enable zero crossing detection** option. You can enable or disable zero-crossing selectively for these blocks only if you have selected the Use local settings setting of the **Zero**

crossing control control on the **Solver** pane of the **Configuration Parameters** dialog box.

Variable-Step Continuous Solver Options

The following options appear when you select any of the Simulink variable-step continuous solvers.

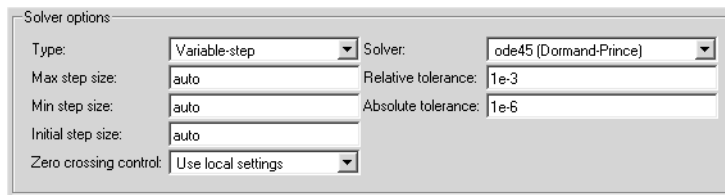

Max step size. Specifies the largest time step the solver can take. The default is determined from the start and stop times. If the stop time equals the start time or is `inf`, Simulink chooses 0.2 sec. as the maximum step size. Otherwise, it sets the maximum step size to

$$h_{max} = \frac{t_{stop} - t_{start}}{50}$$

Generally, the default maximum step size is sufficient. If you are concerned about the solver's missing significant behavior, change the parameter to prevent the solver from taking too large a step. If the time span of the simulation is very long, the default step size might be too large for the solver to find the solution. Also, if your model contains periodic or nearly periodic behavior and you know the period, set the maximum step size to some fraction (such as 1/4) of that period.

In general, for more output points, change the refine factor, not the maximum step size. For more information, see "Output options" on page 10-42.

Initial step size. By default, the solver selects an initial step size by examining the derivatives of the states at the start time. If the first step size is too large, the solver might step over important behavior. The initial step size parameter is a *suggested* first step size. The solver tries this step size but reduces it if error criteria are not satisfied.

Min step size. This option appears only for variable-step continuous solvers. Specifies the smallest time step the selected variable-step solver can take. If the solver needs to take a smaller step to meet error tolerances, it issues a warning indicating the current effective relative tolerance. This parameter can be either a real number greater than zero or a two-element vector where the first element is the minimum step size and the second element is the maximum number of minimum step size warnings to be issued before issuing an error. Setting the second element to zero results in an error the first time the solver must take a step smaller than the specified minimum. This is equivalent to changing the minimum step size violation diagnostic to error on the **Diagnostics** pane. Setting the second element to -1 results in an unlimited number of warnings. This is also the default if the input is a scalar. The default values for this parameter are a minimum step size on the order of machine precision and an unlimited number of warnings.

Relative tolerance. Relative tolerance for this solver (see “Specifying Variable-Step Solver Error Tolerances” on page 10-14).

Absolute tolerance. Absolute tolerance for this solver (see “Specifying Variable-Step Solver Error Tolerances” on page 10-14).

Maximum order. This option appears only if you select the ode15s solver, which is based on NDF formulas of orders one through five. Although the higher order formulas are more accurate, they are less stable. If your model is stiff and requires more stability, reduce the maximum order to 2 (the highest order for which the NDF formula is A-stable). As an alternative, you can try using the ode23s solver, which is a lower order (and A-stable) solver.

Fixed-Step Solver Options

The following options appear when you choose one of the Simulink fixed-step solvers.

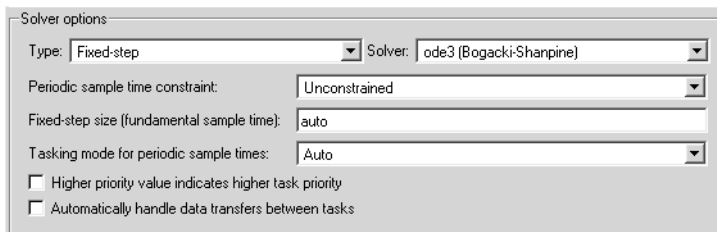

Periodic sample time constraint. Allows you to specify constraints on the sample times defined by this model. During simulation, Simulink checks to ensure that the model satisfies the constraints. If the model does not satisfy the specified constraint, Simulink displays an error message. The contents of the **Solver options** group changes depending on the options selected. The options are

- **Unconstrained**

No constraints. Selecting this option causes Simulink to display a field for entering the solver step size.

See “Fixed step size (fundamental sample time)” on page 10-36 for a description of this field.

- **Ensure sample time independent**

Check to ensure that this model can inherit its sample times from a model that references it without altering its behavior. Models that specify a step size (i.e., a base sample time) cannot satisfy this constraint. For this reason, selecting this option causes Simulink to hide the group’s step size field (see “Fixed step size (fundamental sample time)” on page 10-36.

- **Specified**

Check to ensure that this model operates at a specified set of prioritized periodic sample times.

Selecting this option causes Simulink to display additional controls for specifying prioritized sample times and sample time priority options.

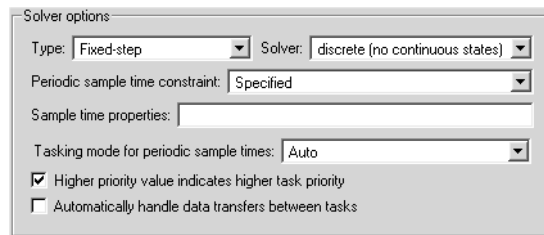

See below for a description of these additional controls.

Fixed step size (fundamental sample time). Specifies the step size used by the selected fixed-step solver. Entering auto (the default) in this field causes Simulink to choose the step size. If the model specifies one or more periodic sample times, Simulink chooses a step size equal to the least common denominator of the specified sample times. This step size, known as the

fundamental sample time of the model, ensures that the solver will take a step at every sample time defined by the model. If the model does not define any periodic sample times, Simulink chooses a step size that divides the total simulation time into 50 equal steps.

Sample time properties. Specifies and assigns priorities to the sample times that this model implements. Enter an Nx3 matrix in this field whose rows specify the sample times specified by this model in order from fastest rate to slowest rate.

Note If the model's fundamental rate differs from the fastest rate specified by the model (see "Determining Step Size for Discrete Systems" on page 2-36), you should specify the fundamental rate as the first entry in the matrix followed by the specified rates in order from fastest to slowest.

The row for each sample time should have the form

[period, offset, priority]

where *period* is the sample time's period of a sample time, *offset* is the sample time's offset, and *priority* is the execution priority of the real-time task associated with the sample rate, with faster rates receiving higher priorities. For example, the following entry

[[0.1, 0, 10]; [0.2, 0, 11]; [0.3, 0, 12]]

declares that this model should specify two sample rates, whose fundamental sample time is 0.1 second, and assigns priorities of 10, 11, and 12 to the sample times. This example assumes that for this model, higher priority values indicate lower priorities, i.e., the **Higher priority value indicates higher task priority** option is not selected (see "Higher priority value indicates higher task priority" on page 10-39).

Note If your model operates at only one rate, you can enter the rate as a three-element vector in this field, e.g., [0.1, 0, 10].

When updating a model, Simulink checks the sample times defined by the model against this field. If the model defines more or fewer sample times than this field specifies, Simulink displays an error message.

Note If you select Unconstrained as the **Periodic sample time constraint**, Simulink assigns a priority of 40 to the model's base sample rate. If the **Higher priority value indicates higher task priority** option is selected (see "Higher priority value indicates higher task priority" on page 10-39), Simulink assigns priorities 39, 38, etc., to subrates of the base rate; otherwise, it assigns priorities 41, 42, 43, etc., to the subrates. Continuous rate is assigned a higher priority than is the discrete base rate no matter whether you select Specified or Unconstrained as the **Periodic sample time constraint**.

Tasking mode for periodic sample times. Specifies one of the following options:

- MultiTasking

This mode issues an error if it detects an illegal sample rate transition between blocks, that is, a direct connection between blocks operating at different sample rates. In real-time multitasking systems, illegal sample rate transitions between tasks can result in a task's output not being available when needed by another task. By checking for such transitions, multitasking mode helps you to create valid models of real-world multitasking systems, where sections of your model represent concurrent tasks.

Use the Rate Transition block to eliminate illegal rate transitions from your model. For more information, see "Models with Multiple Sample Rates" in the Real-Time Workshop documentation for more information.

- SingleTasking

This mode does not check for sample rate transitions among blocks. This mode is useful when you are modeling a single-tasking system. In such systems, task synchronization is not an issue.

- Auto

This option causes Simulink to use single-tasking mode if all blocks operate at the same rate and multitasking mode if the model contains blocks operating at different rates.

Higher priority value indicates higher task priority. If checked, this option indicates that the real-time system targeted by this model assigns a higher priority to tasks with higher priority values. This in turn causes Simulink Rate Transition blocks to treat asynchronous transitions between rates with lower priority values to rates with higher priority values as low-to-high rate transitions. If unchecked (the default), this option indicates that the real-time system targeted by this model assigns a higher priority to tasks with lower priority values. This in turn causes Simulink Rate Transition blocks to treat asynchronous transitions between rates with lower priority values to rates with higher priority values as high-to-low rate transitions. See the Real-Time Workshop documentation for more information on this option.

Automatically handle data transfers between tasks. If checked, this option causes Simulink to insert hidden Rate Transition blocks where rate transitions occur between blocks.

The next two options appear only if you select the ode14x solver (see “Implicit Fixed-Step Continuous Solvers” on page 10-11).

Extrapolation Order. Extrapolation order used by the ode14x solver to compute a model’s states at the next time step from the states at the current time step. The higher the order, the more accurate but the more computationally intensive is the solution per step size.

Number Newton’s iterations. Number of Newton’s method iterations used by the ode14x solver to compute a model’s states at the next time step from the states at the current time step. The more iterations, the more accurate but the more computationally intensive is the solution per step size.

Data Import/Export Pane

The **Data Import/Export** pane allows you to import and export data to the MATLAB workspace. To display the pane, select **Data Import/Export** from the **Select** tree of the **Configuration Parameters** dialog box or select a

configuration set (see “Configuration Sets” on page 10-26) in the Model Explorer and display the configuration’s **Data Import/Export** subset.

The screenshot shows a configuration panel with three sections:

- Load from workspace:** Contains two unchecked checkboxes. The first is labeled "Input:" with a text field containing "[t, u]". The second is labeled "Initial state:" with a text field containing "xInitial".
- Save to workspace:** Contains four checkboxes. "Time:" is checked with a text field containing "tout". "States:" is unchecked with a text field containing "xout". "Output:" is checked with a text field containing "yout". "Final states:" is unchecked with a text field containing "xFinal".
- Save options:** Contains four controls: "Limit data points to last:" is checked with a text field containing "1000"; "Decimation:" is a text field containing "1"; "Format:" is a dropdown menu set to "Array"; and "Signal logging name:" is a text field containing "logargout".

Load from workspace

This group contains controls that enable you to specify options for importing data from the MATLAB workspace.

This close-up shows the "Load from workspace" section, which includes:

- An unchecked checkbox labeled "Input:" followed by a text field containing "[t, u]".
- An unchecked checkbox labeled "Initial state:" followed by a text field containing "xInitial".

It includes the following controls.

Input. A MATLAB expression that specifies the data to be imported from the MATLAB workspace. See “Importing Input Data from the MATLAB Workspace” on page 10-16 for information on how to use this field.

Initial state. A MATLAB expression that specifies the initial values of a model’s states. See “Importing and Exporting States” on page 10-22 for more information.

Save to workspace

This group contains controls that enable you to specify options for exporting data to the MATLAB workspace.

It includes the following controls.

Time. Name of the MATLAB variable to be used to store simulation time data to be exported during simulation.

States. Specifies the name of a MATLAB variable to be used to store state data exported during a simulation. See “Importing and Exporting States” on page 10-22 for more information.

Output. Name of the MATLAB variable to be used to store signal data exported during this simulation. See “Exporting Output Data to the MATLAB Workspace” on page 10-20 for more information.

Final states. Specifies the name of a MATLAB variable to be used to store the values of this model’s states at the end of a simulation. See “Importing and Exporting States” on page 10-22 for more information.

Save options

This group contains controls that allow you to specify options for saving (and reloading) data from the MATLAB workspace.

It includes the following controls.

Limit data points to last. Limits the number of data points exported to the MATLAB workspace to N, the number specified in the adjacent edit field. At the

end of the simulation, the MATLAB workspace contains the last N points generated by the simulation.

Decimation. If specified, Simulink outputs only every N points, where N is the specified decimation factor.

Format. Specifies the format of state and output data saved to or loaded from the MATLAB workspace. The options are

- Array

The format of the data is a matrix each row of which corresponds to a simulation time step.

- Structure with time

The format of the data is a structure that has two fields: a time field and a signals field. The time field contains a vector of simulation times. The signals field contains a substructure for each model input port (for imported data) or output port (for exported data). Each port substructure contains signal data for the corresponding port.

- Structure

The format of the data is a structure that contains substructures for each port. Each port substructure contains signal data for the corresponding port.

See “Importing and Exporting Simulation Data” on page 10-16 for more information on these formats.

Signal logging name. Variable name used to store signals logged during a simulation (see “Logging Signals” on page 6-27).

Output options. Options for generating additional output signal data.

Note These options appear only if the model specifies a variable-step solver (see “The Solver Pane” on page 10-31).

The options are

- Refine output

Output data between as well as at simulation times steps. Selecting this option causes the **Refine factor** edit field to appear below this control (see

“Refine factor” on page 10-43). Use this field to specify the number of points to generate between simulation time steps. For more information, see “Refining Output” on page 10-24.

- Produce additional output
Produce additional output at specified times. Selecting this option causes the **Output times** field to appear. Use this field to specify the simulation times at which Simulink should generate additional output.
- Produce specified output
Produce output only at specified times. Selecting this option causes the **Output times** field to appear. Use this field to specify the simulation times at which Simulink should generate additional output.

Refine factor. This field appears when you select **Refine output** as the value of **Output options**. It specifies how many points to generate between time steps. For example, a refine factor of 2 provides output midway between the time steps, as well as at the steps. The default refine factor is 1. For more information, see “Refining Output” on page 10-24.

Output times. This field appears when you select **Produce additional output** or **Produce specified output** as the value of **Output options**. Use this field to specify times at which Simulink should generate output in addition to or instead of at the simulation steps taken by the solver used to simulate the model.

The Optimization Pane

The **Optimization** pane allows you to select various options that improve simulation performance and the performance of code generated from this model.

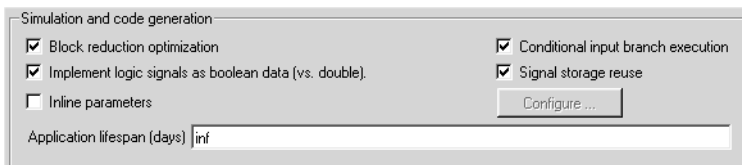

The pane contains the following controls.

Block reduction optimization. Replaces a group of blocks with a synthesized block, thereby speeding up execution of the model.

Conditional input branch execution. This optimization applies to models containing Switch and Multiport Switch blocks. When enabled, this optimization executes only the blocks required to compute the control input and the data input selected by the control input at each time step for each Switch or Multiport Switch block in the model. Similarly, code generated from the model by Real-Time Workshop executes only the code needed to compute the control input and the selected data input. This optimization speeds simulation and execution of code generated from the model.

At the beginning of the simulation or code generation, Simulink examines each signal path feeding a switch block data input to determine the portion of the path that can be optimized. The optimizable portion of the path is that part of the signal path that stretches from the corresponding data input back to the first block that is a nonvirtual subsystem, has continuous or discrete states, or detects zero crossings.

Simulink encloses the optimizable portion of the signal path in an invisible atomic subsystem. During simulation, if a switch data input is not selected, Simulink executes only the nonoptimizable portion of the signal path feeding the input. If the data input is selected, Simulink executes both the nonoptimizable and the optimizable portion of the input signal path.

Inline parameters. By default you can modify (“tune”) many block parameters during simulation (see “Tunable Parameters” on page 2-8). Selecting this option makes all parameters nontunable by default. Making parameters nontunable allows Simulink to move blocks whose outputs depend only on block parameter values outside the simulation loop, thereby speeding up simulation of the model and execution of code generated from the model. When this option is selected, Simulink disables the parameter controls of the block dialog boxes for the blocks in your model to prevent you from accidentally modifying the block parameters.

Simulink allows you to override the **Inline parameters** option for parameters whose values are defined by variables in the MATLAB workspace. To specify that such a parameter remain tunable, specify the parameter as global in the **Model Parameter Configuration** dialog box (see “Model Parameter Configuration Dialog Box” on page 10-47). To display the dialog box, click the

adjacent **Configure** button. To tune a global parameter, change the value of the corresponding workspace variable and choose **Update Diagram (Ctrl+D)** from the Simulink **Edit** menu.

Note You cannot tune inlined parameters in code generated from a model. However, when simulating a model, you can tune an inlined parameter if its value derives from a workspace variable. For example, suppose that a model has a Gain block whose **Gain** parameter is inlined and equals a , where a is a variable defined in the model's workspace. When simulating the model, Simulink disables the **Gain** parameter field, thereby preventing you from using the block's dialog box to change the gain. However, you can still tune the gain by changing the value of a at the MATLAB command line and updating the diagram.

Implement logic signals as boolean data (vs. double). Causes blocks that accept Boolean signals to require Boolean signals. If this option is off, blocks that accept inputs of type boolean also accept inputs of type double. For example, consider the following model.

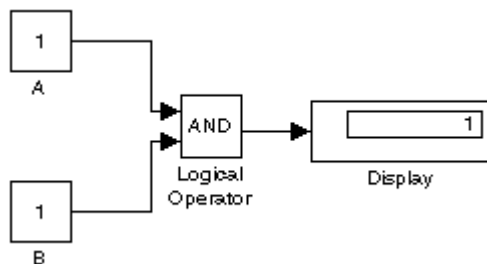

This model connects signals of type double to a Logical Operator block, which accepts inputs of type boolean. If the Boolean logic signals option is on, this model generates an error when executed. If the Boolean logic signals option is off, this model runs without error.

Note This option allows the current version of Simulink to run models that were created by earlier versions of Simulink that supported only signals of type double.

Signal storage reuse. Causes Simulink to reuse memory buffers allocated to store block input and output signals. If this option is off, Simulink allocates a separate memory buffer for each block's outputs. This can substantially increase the amount of memory required to simulate large models, so you should select this option only when you need to debug a model. In particular, you should disable signal storage reuse if you need to

- Debug a C-MEX S-function
- Use a Floating Scope or a Display block with the **Floating display** option selected to inspect signals in a model that you are debugging

Simulink opens an error dialog if `Signal storage reuse` is enabled and you attempt to use a Floating Scope or floating Display block to display a signal whose buffer has been reused.

Application lifespan (days). Specifies the lifespan in days of the system represented by this model. This value and the simulation step size determine the data type used by fixed-point blocks to store absolute time values.

Model Parameter Configuration Dialog Box

The **Model Parameter Configuration** dialog box allows you to override the **Inline parameters** option (see “Inline parameters” on page 10-44) for selected parameters.

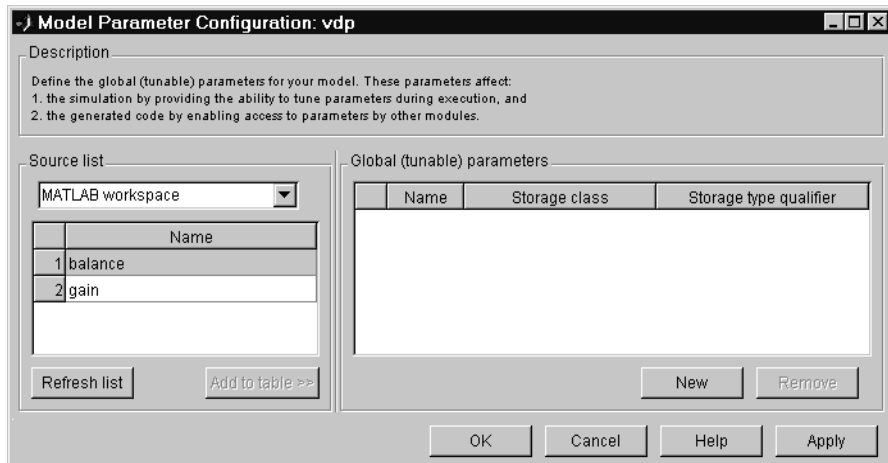

The dialog box has the following controls.

Source list. Displays a list of workspace variables. The options are

- **MATLAB workspace**
List all variables in the MATLAB workspace that have numeric values.
- **Referenced workspace variables**
List only those variables referenced by the model.

Refresh list. Updates the source list. Click this button if you have added a variable to the workspace since the last time the list was displayed.

Add to table. Adds the variables selected in the source list to the adjacent table of tunable parameters.

New. Defines a new parameter and adds it to the list of tunable parameters. Use this button to create tunable parameters that are not yet defined in the MATLAB workspace.

Note This option does not create the corresponding variable in the MATLAB workspace. You must create the variable yourself.

Storage class. Used for code generation. See the Real-Time Workshop documentation for more information.

Storage type qualifier. Used for code generation. See the Real-Time Workshop documentation for more information.

The Diagnostics Pane

The **Diagnostics** configuration parameters pane enables you to specify what diagnostic action Simulink should take, if any, when it detects an abnormal condition during compilation or simulation of a model.

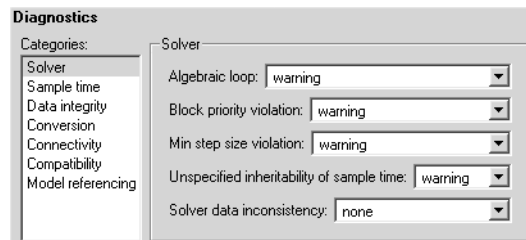

The options are typically to do nothing or to display a warning or an error message (see “Diagnosing Simulation Errors” on page 10-72). A warning message does not terminate a simulation, but an error message does.

The pane displays groups of controls corresponding to various categories of abnormal conditions that can occur during a solution. To display controls for a specific category, left-click the category in the **Categories** list on the left side of the **Diagnostics** pane. To display controls for additional categories, left-click the categories while pressing the **Ctrl** key on your keyboard. See the following sections for information on using the controls on the **Diagnostics** pane:

- “Solver Diagnostics” on page 10-49
- “Sample Time Diagnostics” on page 10-51
- “Data Integrity Diagnostics” on page 10-52

- “Conversion Diagnostics” on page 10-54
- “Connectivity Diagnostics” on page 10-55
- “Compatibility Diagnostics” on page 10-56
- “Model Reference Diagnostics” on page 10-60

Solver Diagnostics

This control group enables you to specify the diagnostic action that Simulink should take when it detects a solver-related error.

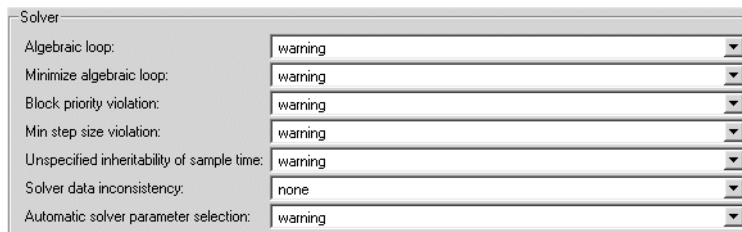

Solver	
Algebraic loop:	warning
Minimize algebraic loop:	warning
Block priority violation:	warning
Min step size violation:	warning
Unspecified inheritability of sample time:	warning
Solver data inconsistency:	none
Automatic solver parameter selection:	warning

Algebraic loop. Simulink detected an algebraic loop while compiling the model. See “Algebraic Loops” on page 2-24 for more information. If you set this option to Error, Simulink displays an error message and highlights the portion of the block diagram that comprises the loop (see “Highlighting Algebraic Loops” on page 2-26).

Minimize algebraic loop. Specifies diagnostic action to take if you have requested that Simulink attempt to remove algebraic loops involving a specified subsystem (see “Eliminating Algebraic Loops” on page 2-27) and an input port of that subsystem has direct feedthrough. If the port is involved in an algebraic loop, Simulink can remove the loop only if at least one other input port in the loop lacks direct feedthrough.

Block priority violation. Simulink detected a block priority specification error while compiling the model.

Min step size violation. The next simulation step is smaller than the minimum step size specified for the model. This can occur if the specified error tolerance for the model requires a step size smaller than the specified minimum step size. See “Min step size” on page 10-35 and “Maximum order” on page 10-35 for more information.

Unspecified inheritability of sample time. Specifies diagnostic action to be taken if this model contains S-functions that do not specify whether they preclude this model from inheriting their sample times from a parent model. Simulink checks for this condition only if the solver used to simulate this model is a fixed-step discrete solver and the periodic sample time constraint for the solver is set to ensure sample time independence (see “Periodic sample time constraint” on page 10-36).

Solver data inconsistency. Consistency checking is a debugging tool that validates certain assumptions made by Simulink ODE solvers. Its main use is to make sure that S-functions adhere to the same rules as Simulink built-in blocks. Because consistency checking results in a significant decrease in performance (up to 40%), it should generally be set to none. Use consistency checking to validate your S-functions and to help you determine the cause of unexpected simulation results.

To perform efficient integration, Simulink saves (caches) certain values from one time step for use in the next time step. For example, the derivatives at the end of a time step can generally be reused at the start of the next time step. The solvers take advantage of this to avoid redundant derivative calculations.

Another purpose of consistency checking is to ensure that blocks produce constant output when called with a given value of t (time). This is important for the stiff solvers (ode23s and ode15s) because, while calculating the Jacobian matrix, the block’s output functions can be called many times at the same value of t .

When consistency checking is enabled, Simulink recomputes the appropriate values and compares them to the cached values. If the values are not the same, a consistency error occurs. Simulink compares computed values for these quantities:

- Outputs
- Zero crossings
- Derivatives
- States

Automatic solver parameter selection. Specifies diagnostic action to take if Simulink changes a solver parameter setting. For example, suppose that you simulate a discrete model that specifies a continuous solver and warning as the setting for

this diagnostic. In this case, Simulink changes the solver type to discrete and displays a warning message about this change at the MATLAB command line.

Sample Time Diagnostics

This control group enables you to specify the diagnostic action that Simulink should take when it detects a compilation error related to model sample times.

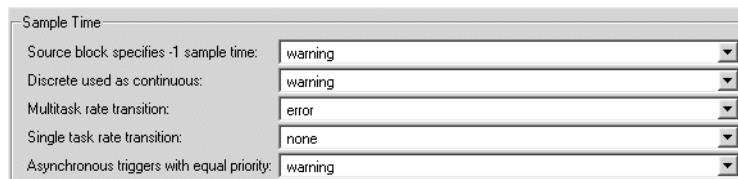

Source block specifies -1 sample time. A source block (e.g., a Sine Wave block) specifies a sample time of -1.

Discrete used as continuous. The Unit Delay block, which is a discrete block, inherits a continuous sample time from the block connected to its input.

Multitask rate transition. An invalid rate transition occurred between two blocks operating in multitasking mode (see “Tasking mode for periodic sample times” on page 10-38).

Single task rate transition. A rate transition occurred between two blocks operating in single-tasking mode (see “Tasking mode for periodic sample times” on page 10-38).

Asynchronous triggers with equal priority. One asynchronous task of the target represented by this model has the same priority as another of the target’s asynchronous tasks. This option must be set to Error if the target allows tasks having the same priority to preempt each other.

Data Integrity Diagnostics

This control group enables you to specify the diagnostic action that Simulink should take when it detects a condition that could compromise the integrity of data defined by the model.

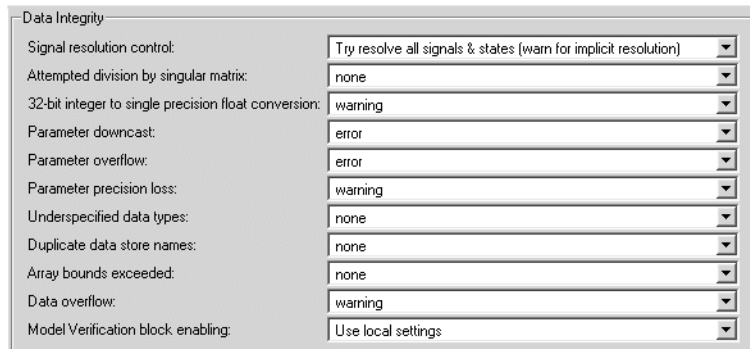

Signal resolution control. Specifies how Simulink resolves signals to Simulink.Signal objects in the MATLAB workspace. The options are

- **Try resolve all signals & states (warn for implicit resolution)**
Try to resolve every signal or discrete state that has a name to a Simulink.Signal object having the same name. Display a warning message if a signal or state resolves implicitly to a signal object, i.e., a signal object with the same name as the signal or state exists in the MATLAB workspace but the model does not specify that the signal or state should resolve to a signal object.
- **Try resolve all signals & states**
Try to resolve every signal or discrete state that has a name to a Simulink.Signal object having the same name regardless of whether the model specifies that the signal or state should resolve to a signal object.
- **Use local settings**
Try to resolve every signal or discrete state that the model specifies should resolve to a Simulink.Signal object in the MATLAB workspace.

Note Use the Signal Properties dialog box (see “Signal Properties Dialog Box” on page 6-30) to specify explicit resolution for signals. Use the **State Properties** dialog boxes of blocks that have discrete states, e.g., the Discrete-Time Integrator block, to specify explicit resolution for discrete states.

Attempted division by singular matrix. The Product block detected a singular matrix while inverting one of its inputs in matrix multiplication mode.

32-bit integer to single precision float conversion. A 32-bit integer value was converted to a floating-point value. Such a conversion can result in a loss of precision. See “Working with Data Types” on page 7-2 for more information.

Parameter downcast. Computation of the output of the block required converting the parameter’s specified type to a type having a smaller range of values (e.g., from uint32 to uint8). This diagnostic applies only to named tunable parameters.

Parameter overflow. The data type of the parameter could not accommodate the parameter’s value.

Parameter precision loss. Computation of the output of the block required converting the specified data type of the parameter to a less precise data type (e.g., from double to uint8).

Underspecified data types. Simulink could not infer the data type of a signal during data type propagation.

Duplicate data store names. The model contains multiple Data Store Memory blocks that specify the same data store name.

Array bounds exceeded. This option causes Simulink to check whether a block writes outside the memory allocated to it during simulation. Typically this can happen only if your model includes a user-written S-function that has a bug. If enabled, this check is performed for every block in the model every time the block is executed. As a result, enabling this option slows down model execution considerably. Thus, to avoid slowing down model execution needlessly, you should enable the option only if you suspect that your model contains a

user-written S-function that has a bug. See *Writing S-Functions* for more information on using this option.

Data overflow. The value of a signal or parameter is too large to be represented by the signal or parameter's data type. See "Working with Data Types" on page 7-2 for more information.

Model Verification block enabling. This parameter allows you to enable or disable model verification blocks in the current model either globally or locally. Select one of the following options:

- Use local settings
Enables or disables blocks based on the value of the **Enable assertion** parameter of each block. If a block's **Enable assertion** parameter is on, the block is enabled; otherwise, the block is disabled.
- Enable all
Enables all model verification blocks in the model regardless of the settings of their **Enable assertion** parameters.
- Disable all
Disables all model verification blocks in the model regardless of the settings of their **Enable assertion** parameters.

Conversion Diagnostics

This control group enables you to specify the diagnostic action that Simulink should take when it detects a data type conversion problem while compiling the model.



Unnecessary type conversions. A Data Type Conversion block is used where no type conversion is necessary.

Vector/matrix block input conversion. A vector-to-matrix or matrix-to-vector conversion occurred at a block input (see "Vector or Matrix Input Conversion Rules" on page 6-14).

Connectivity Diagnostics

This control group enables you to specify the diagnostic action that Simulink should take when it detects a problem with block connections while compiling the model.

Diagnostic Category	Diagnostic Action
Invalid function call connection:	error
Signal label mismatch:	none
Unconnected block input ports:	warning
Unconnected block output ports:	warning
Unconnected line:	warning
Unspecified bus object	warning

Invalid function call connection. Simulink has detected an incorrect use of a function-call subsystem in your model (see the “Function-call systems” examples in the Simulink “Subsystem Semantics” library for examples of invalid uses of function-call subsystems. Disabling this error message can lead to invalid simulation results.

Signal label mismatch. The simulation encountered virtual signals that have a common source signal but different labels (see “Virtual Signals” on page 6-4).

Unconnected block input ports. Model contains a block with an unconnected input.

Unconnected block output ports. Model contains a block with an unconnected output.

Unconnected line. Model contains an unconnected line.

Unspecified bus object. Specifies diagnostic action to take while generating a simulation target for a referenced model if any of the model’s root Output blocks is connected to a bus but does not specify a bus object (see `Simulink.Bus`).

Compatibility Diagnostics

This control group enables you to specify the diagnostic action that Simulink should take when it detects an incompatibility between this version of Simulink and the model when updating or simulating the model.

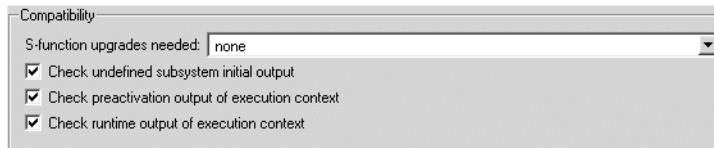

S-function upgrade needed. A block was encountered that has not been upgraded to use features of the current release.

Check undefined subsystem initial output. Display a warning if the model contains a conditionally executed subsystem in which a block with a specified initial condition (e.g., a Constant, Initial Condition, or Delay block) drives an Outport block with an undefined initial condition, i.e., the Outport block's **Initial output** parameter is set to [].

Models with such subsystems can produce initial results (i.e., before initial activation of the conditionally executed subsystem) in the current release that differ from initial results produced in Release 13 or earlier releases.

Consider for example the following model.

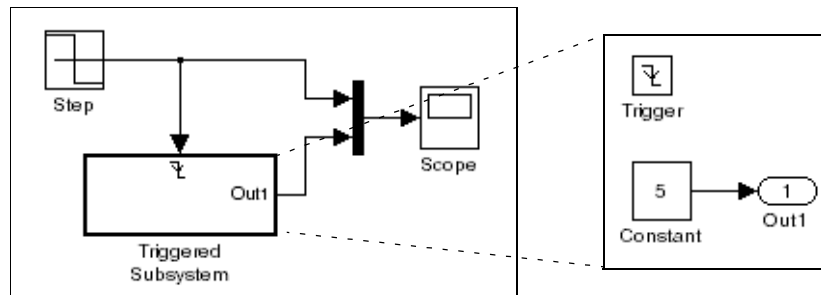

This model does not define the initial condition of the triggered subsystem's output port.

The following figure compares the superimposed output of this model's Step block and the triggered subsystem in Release 13 and the current release.

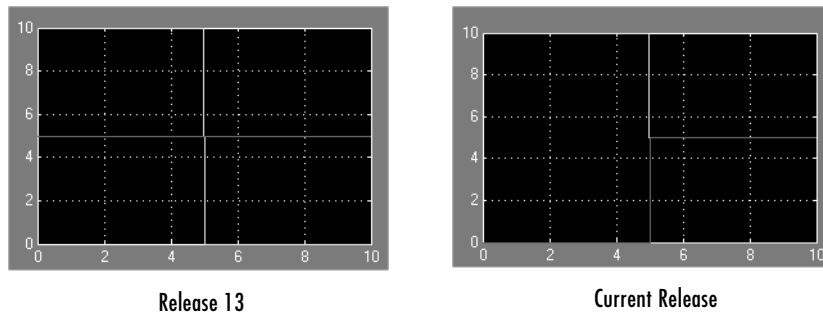

Notice that the initial output of the triggered subsystem differs between the two releases. This is because Release 13 and earlier releases use the initial output of the block connected to the output port (i.e., the Constant block) as the triggered subsystem's initial output. By contrast, this release outputs 0 as the initial output of the triggered subsystem because the model does not specify the port's initial output.

Check preactivation output of execution context. Display a warning if the model contains a block that meets the following conditions:

- The block produces nonzero output for zero input (e.g., a Cosine block).
- The block is connected to an output of a conditionally executed subsystem.
- The block inherits its execution context from that subsystem.
- The Outputport to which it is connected has an undefined initial condition, i.e., the Outputport block's **Initial output** parameter is set to [].

Models with blocks that meet these criteria can produce initial results (i.e., before the conditionally executed subsystem is first activated in the current release that differ from initial results produced in Release 13 or earlier releases.

Consider for example the following model.

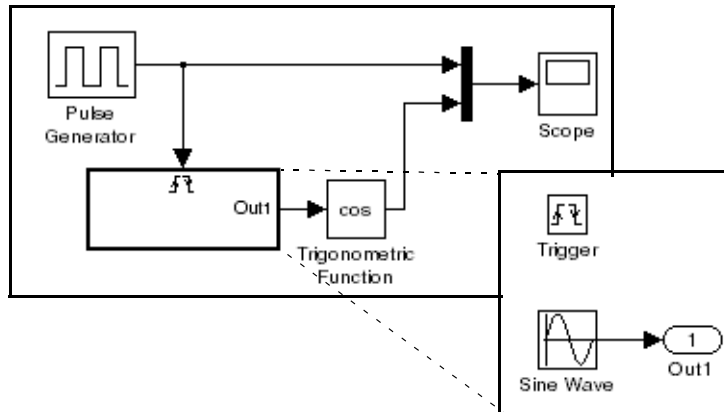

The following figure compares the superimposed output of the Pulse Generator and cos block in Release 13 and the current release.

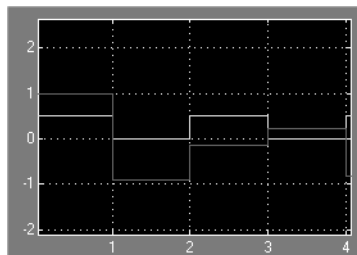

Release 13

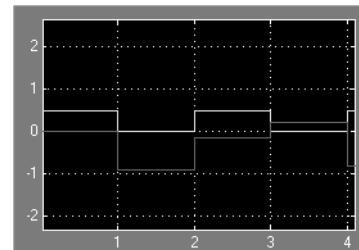

Current Release

Note that the initial output of the cos block differs between the two releases. This is because in Release 13, the cos block belongs to the execution context of the root system and hence executes at every time step whereas in the current release, the cos block belongs to the execution context of the triggered subsystem and hence executes only when the triggered subsystem executes.

Check runtime output of execution context. Display a warning if the model contains a block that meets the following conditions:

- The block has a tunable parameter.

- The block is connected to an output of a conditionally executed subsystem.
- The block inherits its execution context from that subsystem.
- The Output to which it is connected has an undefined initial condition, i.e., the Output block's **Initial output** parameter is set to [].

Models with blocks that meet these criteria can produce results when the parameter is tuned in the current release that differ from results produced in Release 13 or earlier releases.

Consider for example the following model.

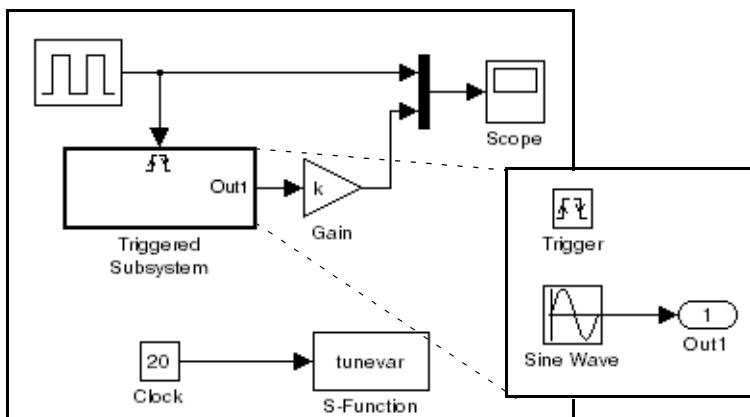

In this model, the `tunevar` S-function changes the value of the Gain block's `k` parameter and updates the diagram at simulation time 7 (i.e., it simulates interactively tuning the parameter).

The following figure compares the superimposed output of the model's Pulse Generator block and its Gain block in Release 13 and the current release.

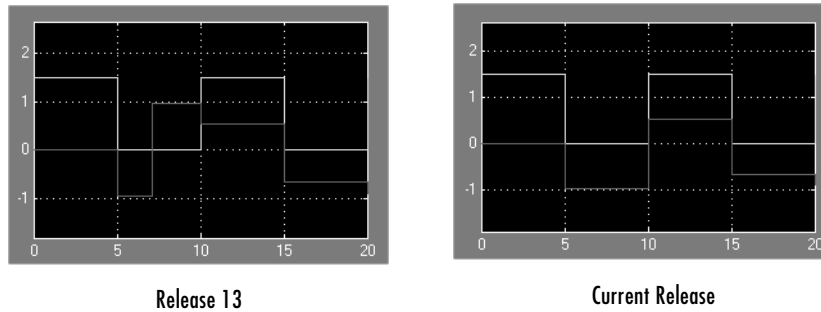

Note that the output of the Gain block changes at time 7 in Release 13 but does not change in the current release. This is because in Release 13, the Gain block belongs to the execution context of the root system and hence executes at every time step whereas in the current release, the Gain block belongs to the execution context of the triggered subsystem and hence executes only when the triggered subsystem executes, i.e., at times 5, 10, 15, and 20.

Model Reference Diagnostics

This control group enables you to specify the diagnostic action that Simulink should take when it detects an incompatibility between this version of Simulink and the model while updating or simulating the model.

Solver	Sample Time	Data Integrity	Conversion	Connectivity	Compatibility	Model Referencing
Model block version mismatch:			none			
Port and parameter mismatch:			none			
Model configuration mismatch:			none			
Invalid root Input/Output block connection:			none			
Unsupported data logging:			warning			

Model block version mismatch. Specifies the diagnostic action to take during loading or updating of this model when Simulink detects a mismatch between the version of the model used to create or refresh a Model block in this model and the referenced model's current version. The options are

- none (the default)

- warning
Refresh the Model block and report a warning message.
- error
Display an error message but do not refresh the Model block.

If you have enabled displaying of referenced model version numbers on Model blocks for this model (see “Displaying Referenced Model Version Numbers” on page 4-65), Simulink displays a version mismatch on the Model block icon as, for example: Rev:1.0 != 1.2.

Port and parameter mismatch. Specifies the diagnostic action to take during model loading or updating when Simulink detects a mismatch between the I/O ports of a Model block in this model and the root-level I/O ports of the model it references or between the parameter arguments recognized by the Model block and the parameter arguments declared by the referenced model. The options are

- none (the default)
- warning
Refresh the out-of-date Model block and report a warning message.
- error
Display an error message but do not refresh the out-of-date Model block.

Model block icons can display a message indicating port or parameter mismatches. To enable this feature, select **Block display -> Model block I/O mismatch** from the parent model’s **Format** menu.

Model configuration mismatch. Specifies the diagnostic action to take if the configuration parameters of a model referenced by this model do not match this model’s configuration parameters or are inappropriate for a referenced model. The default action is none. Set this diagnostic to warning or error if you suspect that an inappropriate or mismatched configuration parameter may be causing your model to give the wrong result.

Invalid root Inport/Outport block connection. Specifies the diagnostic action to take during code generation if Simulink detects invalid internal connections to this model’s root-level Output port blocks.

When this option is set to error, Simulink reports an error if any of the following types of connections appear in this model.

- A root Output port is connected directly or indirectly to more than one nonvirtual block port, for example:

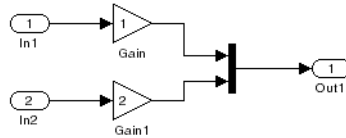

- A root Output port is connected to a root Inport block, a Ground block, or a nondata port (e.g, a state port).

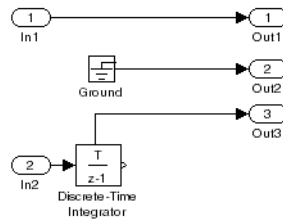

- Two root Output blocks cannot be connected to the same block port.

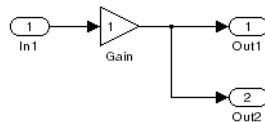

- An Output block cannot be connected to some elements of a block output and not others.

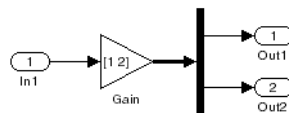

- An Output block cannot be connected more than once to the same element.

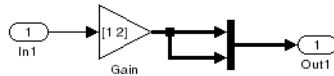

If you select none (the default), Simulink silently inserts blocks to satisfy the constraints wherever possible. In a few cases (such as function-call feedback loops), the inserted blocks may introduce delays and thus may change simulation results.

If you select warning, Simulink warns you that a connection constraint has been violated and attempts to satisfy the constraint by inserting hidden blocks.

Auto-inserting hidden blocks to eliminate root I/O problems stops at subsystem boundaries. Therefore, you may need to manually modify models with subsystems that violate any of the above constraints.

Unsupported data logging. Specifies the diagnostic action to take if this model contains To Workspace blocks or Scope blocks with data logging enabled. The default action warns you that Simulink does not support use of these blocks to log data from referenced models. See “Logging Referenced Model Signals” on page 6-28 for information on how to log signals from a reference to this model.

Hardware Implementation Pane

This pane applies to models of computer-based systems, such as embedded controllers. It allows you to specify the characteristics of the hardware to be used to implement the system represented by this model. This in turn enables

simulation of the model to detect error conditions that could arise on the target hardware, such as hardware overflow.

Embedded hardware (simulation and code generation)

Device type: Unspecified (assume 32-bit Generic)

Number of bits: char: 8 short: 16 int: 32
long: 32 native word size: 32

Byte ordering: Unspecified

Signed integer division rounds to: Undefined

Shift right on a signed integer as arithmetic shift

Emulation hardware (code generation only)

None

This pane contains the following groups of controls.

Embedded hardware

This group of controls enables you to specify the characteristics of the hardware that will be used to implement the production version of the system represented by this model. (See “Emulation hardware” on page 10-66 for information on specifying the characteristics of hardware used to emulate the production hardware.) This group includes the following controls.

Device type. Specifies the type of hardware that will be used to implement the production version of the system represented by this model. The adjacent list lists types of hardware that Simulink knows about and hence does not require you to enter their characteristics. If your production hardware does not match any of the listed types, select *Unspecified (assume 32-bit Generic)* if it has the characteristics of a generic 32-bit microprocessor; otherwise, *Custom*.

Number of bits. This group of controls specifies the length in bits of C data types supported by the selected device type. Simulink disables these controls if it knows the data type lengths for the selected device type.

Native word size. Specifies the word length in bits of the selected production hardware device type. Simulink disables this field if it knows the word length of the selected device type.

Signed integer division rounds to. Specifies how an ANSI C conforming compiler used to compile code for the production hardware rounds the result of dividing

one signed integer by another to produce a signed integer quotient. The options are

- Zero

If the ideal quotient is between two integers, the compiler chooses the integer that is closest to zero as the result.

- Floor

If the ideal quotient is between two integers, the compiler chooses the integer that is closest to negative infinity as the result.

- Undefined

The compiler's rounding behavior is undefined if either or both operands are negative.

The following table illustrates the compiler behavior specified by these options.

N	D	Ideal N/D	Zero	Floor	Undefined
33	4	8.25	8	8	8
-33	4	-8.25	-8	-9	-8 or -9
33	-4	-8.25	-8	-9	-8 or -9
-33	-4	8.25	8	8	-8 or -9

The setting of this option affects only generation of code from the model (see the Real-Time Workshop documentation for information on how this option affects code generation). Use the **Round integer calculations toward** parameter settings on your model's blocks to simulate the rounding behavior of the C compiler that you intend to use to compile code generated from the model. This setting appears on the **Signal data type** pane of the parameter dialog boxes of blocks that can perform signed integer arithmetic, such as the Product and Sum blocks.

Shift right on a signed integer as arithmetic shift. Select this option if the C compiler implements a signed integer right shift as an arithmetic right shift. An arithmetic right shift fills bits vacated by the right shift with the value of the most significant bit, which indicates the sign of the number in twos

complement notation. It is equivalent to dividing the number by 2. This setting affects only code generation.

Byte ordering. Specifies the significance of the first byte of a data word of the target hardware. Select **Big Endian** if the first byte is the most significant, **Little Endian** if it is the least significant, or **Unspecified** if the significance is unknown. This setting affects only code generation. See the Real-Time Workshop documentation for more information.

Emulation hardware

This group of controls allows you to specify the characteristics of hardware used to test code generated from this model.

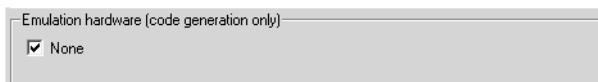

Initially, this group of controls has only one control.

None. If checked, this check box specifies that the hardware used to test the code generated from this model is the same as the production hardware or has the same characteristics. If you plan to use emulation hardware that has different characteristics, unselect this check box. This causes Simulink to expand the group to display controls that allow you to specify the characteristics of the emulation hardware.

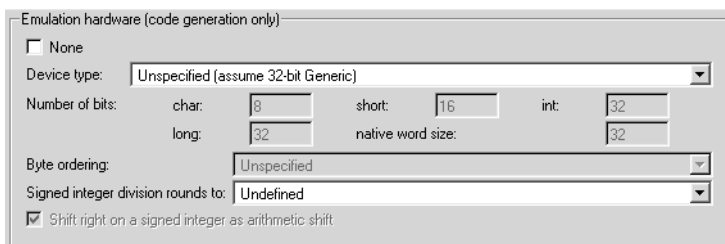

The additional controls are identical to the ones used to specify the characteristics of the target hardware for your system. See “Embedded hardware” on page 10-64 for information on using these controls.

Model Referencing Pane

The **Model Referencing** pane allows you to specify options for including other models in this model and this model in other models and for building simulation and code generation targets.

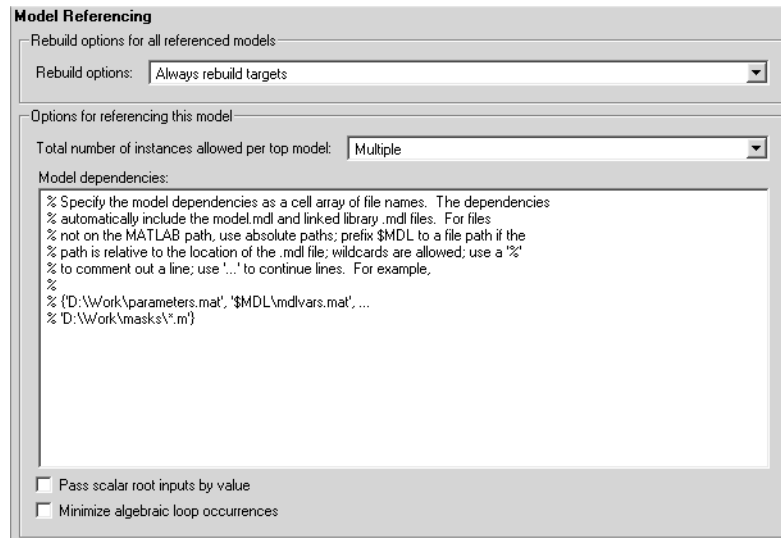

Note The option descriptions use the term *this model* to refer to the model that you are configuring and the term *referenced model* to designate models referenced by *this model*.

The pane includes controls for specifying options for

- Including other models in this model (see “Rebuild options for all referenced models” on page 10-67)
- Including the current model in other models (see “Options for referencing this model” on page 10-69)

Rebuild options for all referenced models

This group allows you to specify rebuild options for models directly or indirectly referenced by this model. It includes the following controls.

Rebuild targets. This control specifies whether to rebuild simulation and Real-Time Workshop targets for referenced models before updating, simulating, or generating code from this model. This includes models indirectly referenced by this model. The options, in order from safe and slow to fast and risky, are

- **Always rebuild targets**
Always rebuild all targets referenced by this model before simulating, updating, or generating code from it.
- **If any changes detected (the default)**
Rebuild the target for a referenced model if Simulink detects any changes of any kind in the target's dependencies. The dependencies include
 - The referenced model's model file
 - Block library files used by the referenced model
 - Targets of models referenced by the referenced model
 - S-functions and associated TLC files used by the referenced model
 - User-specified dependencies (see "Model dependencies" on page 10-70)
 - Workspace variables used by the referenced model

This also checks for changes in the compiled form of the referenced model. Checking the compiled model can detect some changes that occur even in dependencies that you do not specify.

- **If any changes in known dependencies detected**
Rebuild a target if Simulink detects any changes in known target dependencies (see above) since the target was last built. This option ignores cosmetic changes, such as annotation changes, in the referenced model and in any block library dependencies, thus preventing unnecessary rebuilds. However, before selecting it, you should be certain that you have specified every user-created dependency (e.g., M-files or MAT-files) for this model to ensure that all targets that need to be rebuilt are rebuilt. Otherwise, invalid simulation results may occur.

Note that this option cannot detect changes in unspecified dependencies, such as M-files used to initialize block masks. If you suspect that a model has such unknown dependencies, you can still guarantee valid simulation by selecting the Always rebuild targets or the If any changes detected option.

- `Never rebuild targets`

Never rebuild targets before simulating or generating code from this model. If you are certain that your targets are up-to-date, you can use this option to avoid time-consuming target dependency checking when simulating, updating, or generating code from a model. Use this option with caution because it may lead to invalid results if referenced model targets are not in fact up-to-date.

Note It is a good idea to use the `Always rebuild targets` option before deployment of a model to assure that all the model reference targets are up-to-date.

Never rebuild targets diagnostic. This control appears only if you select the `Never rebuild targets` option. It allows you to specify the diagnostic action that Simulink should take if it detects a target that needs to be rebuilt. The options are

- `Error if targets require rebuild` (the default)
- `Warn if targets require rebuild`
- `None`

Selecting `None` bypasses dependency checking, and thus enables faster updating, simulation, and code generation, but can cause models that are not up-to-date to malfunction or generate incorrect results.

Options for referencing this model

This group of controls specifies options for including this model in other models. It includes the following controls.

Total number of instances allowed per top model. This option allows you to specify how many references to this model (i.e., the model you are configuring) can safely occur in another model. The options are

- `One`
- `Multiple` (the default)
- `None`

If you specify `None`, and a reference to this model occurs in another model (including its model references), Simulink displays an error when you try to simulate or update the root model. Simulink similarly displays an error, if you specify `One` and multiple references to this model occur in a root model (including its model references). If you specify `multiple` and Simulink determines that for some reason this model cannot be multiply referenced, Simulink displays an error when the model that references it is compiled or simulated. This occurs even if the model is referenced only once.

Model dependencies. Specifies files on which this model relies. They are typically MAT-files and M-files used to initialize parameters and to provide data.

Specify the dependencies as a cell array of strings, where each cell array entry is the filename or path of a dependent file. These filenames may include spaces and must include file extensions (e.g., `.m`, `.mat`, etc.).

Prefix the token `$MDL` to a dependency to indicate that the path to the dependency is relative to the location of this model file.

If Simulink cannot find a specified dependent file when you update or simulate a model that references this model, Simulink displays an error.

Pass scalar root inputs by value. Checking this option causes a model that calls (i.e., references) this model to pass this model's scalar inputs by value. Otherwise, the calling model passes the inputs by reference, i.e., it passes the addresses of the inputs rather than the input values.

Passing roots by value allows this model to read its scalar inputs from register or local memory which is faster than reading the inputs from their original locations. However, this option can lead to incorrect results if the model's root scalar inputs can change within a time step. This can happen, for instance, if this model's inputs and outputs share memory locations (e.g., as a result of a feedback loop) and the model is invoked multiple times in a time step (i.e., by a Function-Call Subsystem). In such cases, this model sees scalar input changes that occur in the same time step only if the inputs are passed by reference. That is why this option is off by default. If you are certain that this model is not referenced in contexts where its inputs can change within a time step, select this option to generate more efficient code for this model.

Note Selecting this option can affect reuse of code generated for subsystems. See the Real-Time Workshop documentation for more information.

Minimize algebraic loop occurrences. Checking this option causes Simulink to try to eliminate algebraic loops involving this model from models that reference it. Enabling this option disables conditional input branch optimization for simulation and the Real-Time Workshop single update/output function optimization for code generation. See “Eliminating Algebraic Loops” on page 2-27 for more information.

Diagnosing Simulation Errors

If errors occur during a simulation, Simulink halts the simulation, opens the subsystems that caused the error (if necessary), and displays the errors in the Simulation Diagnostics Viewer. The following section explains how to use the viewer to determine the cause of the errors.

Simulation Diagnostics Viewer

The viewer comprises an Error Summary pane and an Error Message pane.

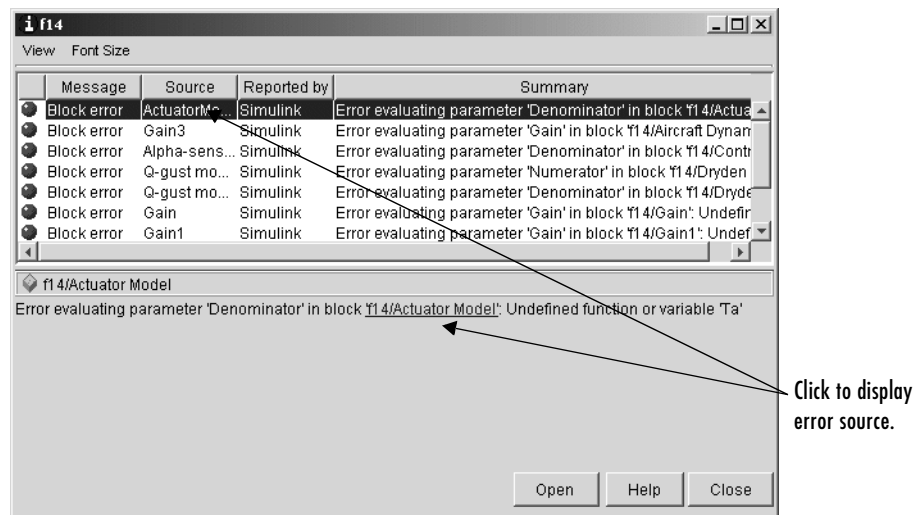

Error Summary Pane

The upper pane lists the errors that caused Simulink to terminate the simulation. The pane displays the following information for each error.

Message. Message type (for example, block error, warning, log)

Source. Name of the model element (for example, a block) that caused the error

Reported by. Component that reported the error (for example, Simulink, Stateflow, Real-Time Workshop, etc.)

Summary. Error message, abbreviated to fit in the column

You can remove any of these columns of information to make more room for the others. To remove a column, select the viewer's **View** menu and uncheck the corresponding item.

Error Message Pane

The lower pane initially contains the contents of the first error message listed in the top pane. You can display the contents of other messages by clicking their entries in the upper pane.

In addition to displaying the viewer, Simulink opens (if necessary) the subsystem that contains the first error source and highlights the source.

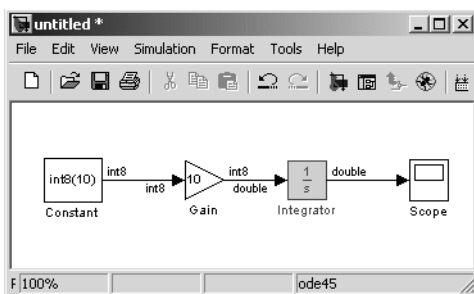

You can display the sources of other errors by clicking anywhere in the error message in the upper pane, by clicking the name of the error source in the error message (highlighted in blue), or by clicking the **Open** button on the viewer.

Changing Font Size

To change the size of the font used to display errors, select **Font Size** from the viewer's menu bar. A menu of font sizes appears. Select the desired font size from the menu.

Creating Custom Simulation Error Messages

The Simulation Diagnostics Viewer displays the output of any instance of the MATLAB error function executed during a simulation, including instances invoked by block or model callbacks or S-functions that you create or that are executed by the MATLAB Fcn block. Thus, you can use the MATLAB error function in callbacks and S-functions or in the MATLAB Fcn block to create simulation error messages specific to your application.

For example, in the following model,

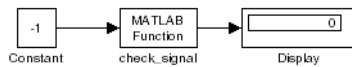

the MATLAB Fcn block invokes the following function:

```
function y=check_signal(x)
    if x<0
        error('Signal is negative.');
```

```
    else
        y=x;
    end
```

Executing this model displays an error message in the Simulation Diagnostics Viewer.

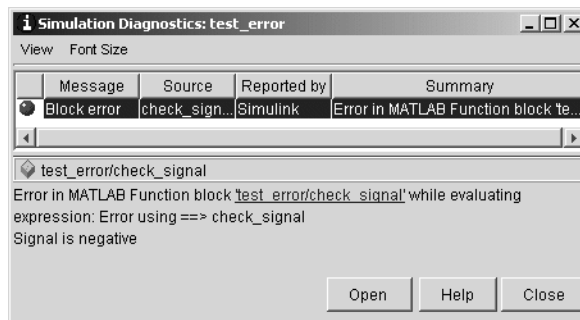

Including Hyperlinks in Error Messages

You can include hyperlinks to blocks, text files, and directories.

To include a hyperlink to a block, path, or directory, include the item's path in the error message enclosed in quotation marks, e.g.,

- `error('Error evaluating parameter in block "myModel/Mu"')`
displays a text hyperlink to the block `Mu` in the current model in the error message. Clicking the hyperlink displays the block in the model window.

- `error ('Error reading data from "c:/work/test.data"')`
displays a text hyperlink to the file `test.data` in the error message. Clicking the link displays the file in your preferred MATLAB editor.
- `error ('Could not find data in directory "c:/work"')`
displays a text hyperlink to the `c:/work` directory. Clicking the link opens a system command window (shell) and sets its working directory to `c:/work`.

Note The text hyperlink is enabled only if the corresponding block exists in the current model or if the corresponding file or directory exists on the user's system.

Improving Simulation Performance and Accuracy

Simulation performance and accuracy can be affected by many things, including the model design and choice of configuration parameters.

The solvers handle most model simulations accurately and efficiently with their default parameter values. However, some models yield better results if you adjust solver parameters. Also, if you know information about your model's behavior, your simulation results can be improved if you provide this information to the solver.

Speeding Up the Simulation

Slow simulation speed can have many causes. Here are a few:

- Your model includes a MATLAB Fcn block. When a model includes a MATLAB Fcn block, the MATLAB interpreter is called at each time step, drastically slowing down the simulation. Use the built-in Fcn block or Math Function block whenever possible.
- Your model includes an M-file S-function. M-file S-functions also cause the MATLAB interpreter to be called at each time step. Consider either converting the S-function to a subsystem or to a C-MEX file S-function.
- Your model includes a Memory block. Using a Memory block causes the variable-order solvers (ode15s and ode113) to be reset back to order 1 at each time step.
- The maximum step size is too small. If you changed the maximum step size, try running the simulation again with the default value (auto).
- Did you ask for too much accuracy? The default relative tolerance (0.1% accuracy) is usually sufficient. For models with states that go to zero, if the absolute tolerance parameter is too small, the simulation can take too many steps around the near-zero state values. See the discussion of error in “Maximum order” on page 10-35.
- The time scale might be too long. Reduce the time interval.
- The problem might be stiff, but you are using a nonstiff solver. Try using ode15s.
- The model uses sample times that are not multiples of each other. Mixing sample times that are not multiples of each other causes the solver to take small enough steps to ensure sample time hits for all sample times.

- The model contains an algebraic loop. The solutions to algebraic loops are iteratively computed at every time step. Therefore, they severely degrade performance. For more information, see “Algebraic Loops” on page 2-24.
- Your model feeds a Random Number block into an Integrator block. For continuous systems, use the Band-Limited White Noise block in the Sources library.

Improving Simulation Accuracy

To check your simulation accuracy, run the simulation over a reasonable time span. Then, either reduce the relative tolerance to 1e-4 (the default is 1e-3) or reduce the absolute tolerance and run it again. Compare the results of both simulations. If the results are not significantly different, you can feel confident that the solution has converged.

If the simulation misses significant behavior at its start, reduce the initial step size to ensure that the simulation does not step over the significant behavior.

If the simulation results become unstable over time,

- Your system might be unstable.
- If you are using ode15s, you might need to restrict the maximum order to 2 (the maximum order for which the solver is A-stable) or try using the ode23s solver.

If the simulation results do not appear to be accurate,

- For a model that has states whose values approach zero, if the absolute tolerance parameter is too large, the simulation takes too few steps around areas of near-zero state values. Reduce this parameter value or adjust it for individual states in the Integrator dialog box.
- If reducing the absolute tolerances does not sufficiently improve the accuracy, reduce the size of the relative tolerance parameter to reduce the acceptable error and force smaller step sizes and more steps.

Running a Simulation Programmatically

Entering simulation commands in the MATLAB Command Window or from an M-file enables you to run unattended simulations. You can perform Monte Carlo analysis by changing the parameters randomly and executing simulations in a loop. You can run a simulation from the command line using the `sim` command or the `set_param` command. Both are described below.

Using the `sim` Command

The full syntax of the command that runs the simulation is

```
[t,x,y] = sim(model, timespan, options, ut);
```

Only the `model` parameter is required. Parameters not supplied on the command are taken from the **Configuration Parameters** dialog box settings.

For detailed syntax for the `sim` command, see the documentation for the `sim` command. The `options` parameter is a structure that supplies additional configuration parameters, including the solver name and error tolerances. You define parameters in the `options` structure using the `simset` command (see `simset`). The configuration parameters are discussed in “Configuration Sets” on page 10-26.

Using the `set_param` Command

You can use the `set_param` command to start, stop, pause, or continue a simulation, or update a block diagram. The format of the `set_param` command for this use is

```
set_param('sys', 'SimulationCommand', 'cmd')
```

where `'sys'` is the name of the system and `'cmd'` is `'start'`, `'stop'`, `'pause'`, `'continue'`, or `'update'`.

Similarly, you can use the `get_param` command to check the status of a simulation. The format of the `get_param` command for this use is

```
get_param('sys', 'SimulationStatus')
```

Simulink returns `'stopped'`, `'initializing'`, `'running'`, `'paused'`, `'updating'`, `'terminating'`, and `'external'` (used with Real-Time Workshop).

Analyzing Simulation Results

The following sections explain how to use Simulink tools for analyzing the results of simulations.

- | | |
|---------------------------------------|---|
| Viewing Output Trajectories (p. 11-2) | Explains how to display your output directories. |
| Linearizing Models (p. 11-4) | Describes functions that extract a linear state-space model from a Simulink model. |
| Finding Steady-State Points (p. 11-7) | How to use the Simulink <code>trim</code> command to determine steady-state points of a system represented by a Simulink model. |

Viewing Output Trajectories

Output trajectories from Simulink can be plotted using one of three methods:

- Feed a signal into either a Scope or an XY Graph block.
- Write output to return variables and use MATLAB plotting commands.
- Write output to the workspace using To Workspace blocks and plot the results using MATLAB plotting commands.

Using the Scope Block

You can display output trajectories on a Scope block during simulation as illustrated by the following model.

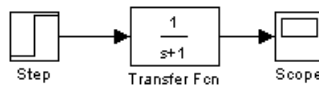

The display on the Scope shows the output trajectory. The Scope block enables you to zoom in on an area of interest or save the data to the workspace.

The XY Graph block enables you to plot one signal against another.

Using Return Variables

By returning time and output histories, you can use MATLAB plotting commands to display and annotate the output trajectories.



The block labeled Out is an Outport block from the Signals & Systems library. The output trajectory, `yout`, is returned by the integration solver. For more information, see “Data Import/Export Pane” on page 10-39.

You can also run this simulation from the **Simulation** menu by specifying variables for the time, output, and states on the **Data Import/Export** pane of the **Configuration Parameters** dialog box. You can then plot these results using

```
plot(tout,yout)
```

Using the To Workspace Block

The To Workspace block can be used to return output trajectories to the MATLAB workspace. The model below illustrates this use.

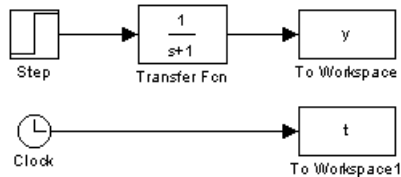

The variables `y` and `t` appear in the workspace when the simulation is complete. You store the time vector by feeding a Clock block into a To Workspace block. You can also acquire the time vector by entering a variable name for the time on the **Data Import/Export** pane of the **Configuration Parameters** dialog box, for menu-driven simulations, or by returning it using the `sim` command (see “Data Import/Export Pane” on page 10-39 for more information).

The To Workspace block can accept an array input, with each input element’s trajectory stored in the resulting workspace variable.

Linearizing Models

Simulink provides the `linmod`, `linmod2`, and `dlinmod` functions to extract linear models in the form of the state-space matrices A , B , C , and D . State-space matrices describe the linear input-output relationship as

$$\begin{aligned} \dot{x} &= Ax + Bu \\ y &= Cx + Du \end{aligned}$$

where x , u , and y are state, input, and output vectors, respectively. For example, the following model is called `lmod`.

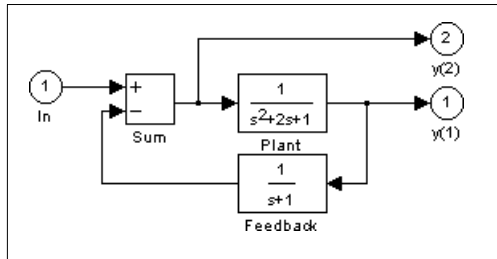

To extract the linear model of this Simulink system, enter this command.

```
[A,B,C,D] = linmod('lmod')
A =
    -2    -1    -1
     1     0     0
     0     1    -1
B =
     1
     0
     0
C =
     0     1     0
     0     0    -1
D =
     0
     1
```

Inputs and outputs must be defined using Inport and Outport blocks from the Signals & Systems library. Source and sink blocks do not act as inputs and

outputs. Inport blocks can be used in conjunction with source blocks, using a Sum block. Once the data is in the state-space form or converted to an LTI object, you can apply functions in the Control System Toolbox for further analysis:

- Conversion to an LTI object
`sys = ss(A,B,C,D);`
- Bode phase and magnitude frequency plot
`bode(A,B,C,D)` or `bode(sys)`
- Linearized time response
`step(A,B,C,D)` or `step(sys)`
`impulse(A,B,C,D)` or `impulse(sys)`
`lsim(A,B,C,D,u,t)` or `lsim(sys,u,t)`

You can use other functions in the Control System Toolbox and Robust Control Toolbox for linear control system design.

When the model is nonlinear, an operating point can be chosen at which to extract the linearized model. The nonlinear model is also sensitive to the perturbation sizes at which the model is extracted. These must be selected to balance the tradeoff between truncation and roundoff error. Extra arguments to `linmod` specify the operating point and perturbation points.

```
para1 = xpert;  
[A,B,C,D] = linmod('sys', x, u, pert, para1)
```

For discrete systems or mixed continuous and discrete systems, use the function `dlinmod` for linearization. This has the same calling syntax as `linmod` except that the second right-hand argument must contain a sample time at which to perform the linearization.

Linearization Using the 'v5' Algorithm

Using `linmod` with the 'v5' option to linearize a model that contains Derivative or Transport Delay blocks can be troublesome. Before linearizing, replace these blocks with specially designed blocks that avoid the problems. These blocks are in the Simulink Extras library in the Linearization sublibrary.

You access the Extras library by opening the Blocksets & Toolboxes icon:

- For the Derivative block, use the Switched derivative for linearization.
- For the Transport Delay block, use the Switched transport delay for linearization. (Using this block requires that you have the Control System Toolbox.)

When using a Derivative block, you can also try to incorporate the derivative term in other blocks. For example, if you have a Derivative block in series with a Transfer Fcn block, it is better implemented (although this is not always possible) with a single Transfer Fcn block of the form

$$\frac{s}{s + a}$$

In this example, the blocks on the left of this figure can be replaced by the block on the right.

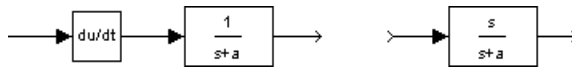

Finding Steady-State Points

The Simulink `trim` function uses a Simulink model to determine steady-state points of a dynamic system that satisfy input, output, and state conditions that you specify. Consider, for example, this model, called `lmod`.

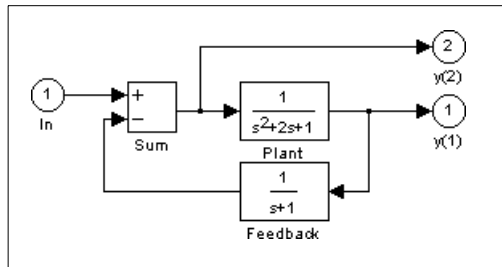

You can use the `trim` function to find the values of the input and the states that set both outputs to 1. First, make initial guesses for the state variables (x) and input values (u), then set the desired value for the output (y).

```
x = [0; 0; 0];
u = 0;
y = [1; 1];
```

Use index variables to indicate which variables are fixed and which can vary.

```
ix = []; % Don't fix any of the states
iu = []; % Don't fix the input
iy = [1;2]; % Fix both output 1 and output 2
```

Invoking `trim` returns the solution. Your results might differ because of roundoff error.

```
[x,u,y,dx] = trim('lmod',x,u,y,ix,iu,iy)

x =
    0.0000
    1.0000
    1.0000
u =
     2
y =
    1.0000
```

```
1.0000
dx =
1.0e-015 *
-0.2220
-0.0227
0.3331
```

Note that there might be no solution to equilibrium point problems. If that is the case, `trim` returns a solution that minimizes the maximum deviation from the desired result after first trying to set the derivatives to zero. For a description of the `trim` syntax, see `trim` in the Simulink online Help.

Creating Masked Subsystems

This section explains how to create custom user interfaces (masks) for Simulink subsystems.

About Masks (p. 12-2)	An overview of masked subsystems that introduces you to key concepts.
Masked Subsystem Example (p. 12-5)	Introduces you to masking by taking you step by step through the creation of a simple masked subsystem.
Masking a Subsystem (p. 12-10)	General procedure for masking subsystems.
The Mask Editor (p. 12-12)	Detailed description of the Mask Editor.
Linking Mask Parameters to Block Parameters (p. 12-27)	How to link a mask's parameters to the parameters of blocks behind the mask.
Creating Dynamic Dialogs for Masked Blocks (p. 12-28)	How to create a mask that changes its appearance based on the options that a user selects.

About Masks

A mask is a custom user interface for a subsystem that hides the subsystem's contents, making it appear to the user as an atomic block with its own icon and parameter dialog box. The Simulink Mask Editor enables you to create a mask for any subsystem. Masking a subsystem allows you to

- Replace the parameter dialogs of a subsystem and its contents with a single parameter dialog with its own block description, parameter prompts, and help text
- Replace a subsystem's standard icon with a custom icon that depicts its purpose
- Prevent unintended modification of subsystems by hiding their contents behind a mask
- Create a custom block by encapsulating a block diagram that defines the block's behavior in a masked subsystem and then placing the masked subsystem in a library

Note You can also mask S-Function and Model blocks. The instructions for masking Subsystem blocks apply to S-Function and Model blocks as well except where noted.

Mask Features

Masks can include any of the following features.

Mask Icon

The mask icon replaces a subsystem's standard icon, i.e., it appears in a block diagram in place of the standard icon for a subsystem block. Simulink uses MATLAB code that you supply to draw the custom icon. You can use any MATLAB drawing command in the icon code. This gives you great flexibility in designing an icon for a masked subsystem.

Mask Parameters

Simulink allows you to define a set of user-settable parameters for a masked subsystem. Simulink stores the value of a parameter in the mask workspace

(see “Mask Workspace” on page 12-4) as the value of a variable whose name you specify. These associated variables allow you to link mask parameters to specific parameters of blocks inside a masked subsystem (internal parameters) such that setting a mask parameter sets the associated block parameter (see “Linking Mask Parameters to Block Parameters” on page 12-27).

Note If you intend to allow the user to specify the model referenced by a masked Model block or a Model block in a masked subsystem, you must ensure that the mask requires that the user specify the model name as a literal value rather than as a workspace variable. This is because Simulink updates model reference targets before evaluating block parameters. The recommended way to force the user to specify the model name as a literal is to use a pop-up control on the mask to specify the model name. See “Pop-Up Control” on page 12-22 for more information.

Mask Parameter Dialog Box

The mask parameter dialog box contains controls that enable a user to set the values of the masks parameters and hence the values of any internal parameters linked to the mask parameters.

The mask parameter dialog box replaces the subsystem’s standard parameter dialog box, i.e., clicking on the masked subsystem’s icon causes the mask dialog box to appear instead of the standard parameter dialog box for a Subsystem block. You can customize every feature of the mask dialog box, including which parameters appear on the dialog box, the order in which they appear, parameter prompts, the controls used to edit the parameters, and the parameter callbacks (code used to process parameter values entered by the user).

Mask Initialization Code

The initialization code is MATLAB code that you specify and that Simulink runs to initialize the masked subsystem at the start of a simulation run. You can use the initialization code to set the initial values of the masked subsystem’s mask parameters.

Mask Workspace

Simulink associates a workspace with each masked subsystem that you create. Simulink stores the current values of the subsystem's parameters in the workspace as well as any variables created by the block's initialization code and parameter callbacks. You can use model and mask workspace variables to initialize a masked subsystem and to set the values of blocks inside the masked subsystem, subject to the following rules.

- A block parameter expression can refer only to variables defined in the mask workspaces of the subsystem or nested subsystems that contain the block or in the model's workspace.
- A valid reference to a variable defined on more than one level in the model hierarchy resolves to the most local definition.

For example, suppose that model M contains masked subsystem A, which contains masked subsystem B. Further suppose that B refers to a variable *x* that exists in both A's and M's workspaces. In this case, the reference resolves to the value in A's workspace.

- A masked subsystem's initialization code can refer only to variables in its local workspace.
- The mask workspace of a Model block is not visible to the model that it references. Any variables used by the referenced model must resolve to workspaces defined in the referenced model or to the base (i.e., the MATLAB) workspace.

Creating Masks

See "Masking a Subsystem" on page 12-10 for an overview of the process of creating a masked subsystem. See "Masked Subsystem Example" on page 12-5 for an example of the process.

Masked Subsystem Example

This simple subsystem models the equation for a line, $y = mx + b$.

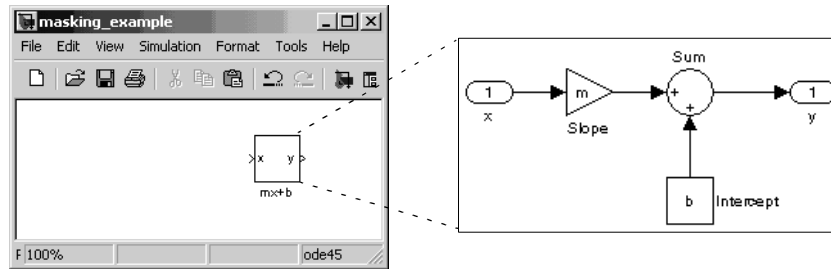

Ordinarily, when you double-click a Subsystem block, the Subsystem block opens, displaying its blocks in a separate window. The $mx + b$ subsystem contains a Gain block, named **Slope**, whose **Gain** parameter is specified as m , and a Constant block, named **Intercept**, whose **Constant value** parameter is specified as b . These parameters represent the slope and intercept of a line.

This example creates a custom dialog box and icon for the subsystem. One dialog box contains prompts for both the slope and the intercept. After you create the mask, double-click the Subsystem block to open the mask dialog box. The mask dialog box and icon look like this:

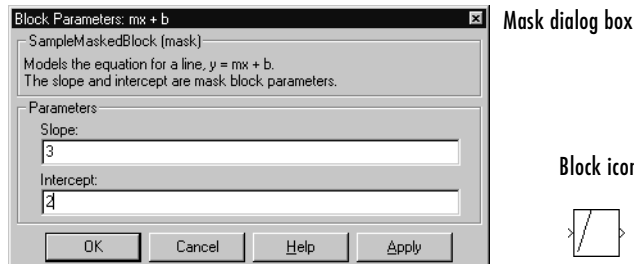

A user enters values for **Slope** and **Intercept** in the mask dialog box. Simulink makes these values available to all the blocks in the underlying subsystem. Masking this subsystem creates a self-contained functional unit with its own application-specific parameters, **Slope** and **Intercept**. The mask maps these *mask parameters* to the generic parameters of the underlying blocks. The

complexity of the subsystem is encapsulated by a new interface that has the look and feel of a built-in Simulink block.

To create a mask for this subsystem, you need to

- Specify the prompts for the mask dialog box parameters. In this example, the mask dialog box has prompts for the slope and intercept.
- Specify the variable name used to store the value of each parameter.
- Enter the documentation of the block, consisting of the block description and the block help text.
- Specify the drawing command that creates the block icon.
- Specify the commands that provide the variables needed by the drawing command (there are none in this example).

Creating Mask Dialog Box Prompts

To create the mask for this subsystem, select the Subsystem block and choose **Mask Subsystem** from the **Edit** menu.

This example primarily uses the Mask Editor's **Parameters** pane to create the masked subsystem's dialog box.

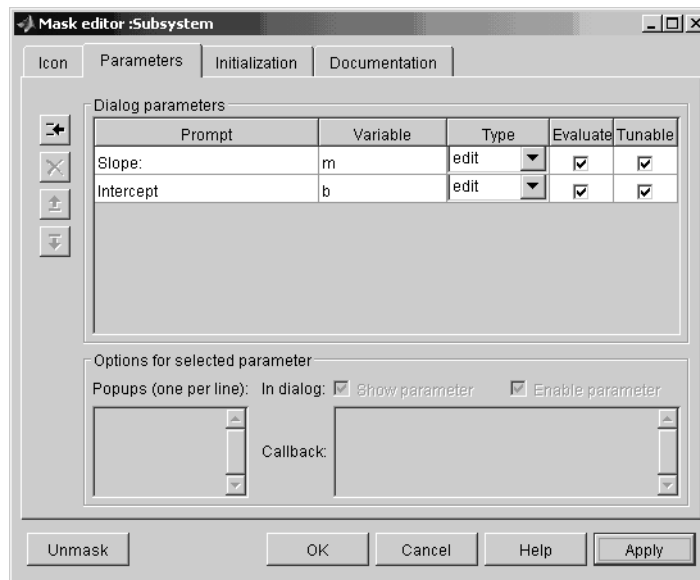

The Mask Editor enables you to specify these attributes of a mask parameter:

- Prompt, the text label that describes the parameter
- Control type, the style of user interface control that determines how parameter values are entered or selected
- Variable, the name of the variable that stores the parameter value

Generally, it is convenient to refer to masked parameters by their prompts. In this example, the parameter associated with slope is referred to as the **Slope** parameter, and the parameter associated with intercept is referred to as the **Intercept** parameter.

The slope and intercept are defined as edit controls. This means that the user types values into edit fields in the mask dialog box. These values are stored in variables in the *mask workspace*. Masked blocks can access variables only in the mask workspace. In this example, the value entered for the slope is assigned to the variable *m*. The Slope block in the masked subsystem gets the value for the slope parameter from the mask workspace. This figure shows how the slope parameter definitions in the Mask Editor map to the actual mask dialog box parameters.

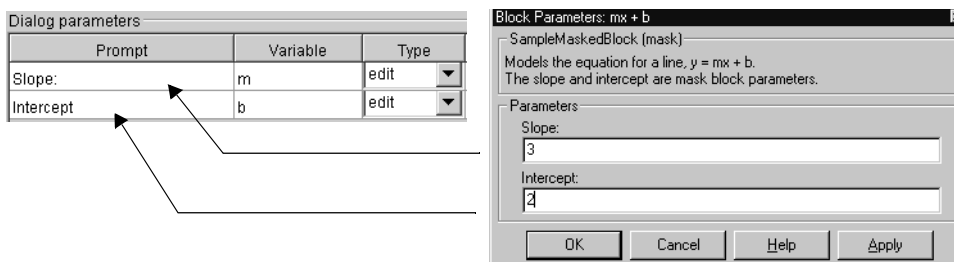

After you create the mask parameters for slope and intercept, click the **OK** button. Then double-click the Subsystem block to open the newly constructed dialog box. Enter 3 for the **Slope** and 2 for the **Intercept** parameter.

Creating the Block Description and Help Text

The mask type, block description, and help text are defined on the **Documentation** pane. For this sample masked block, the pane looks like this.

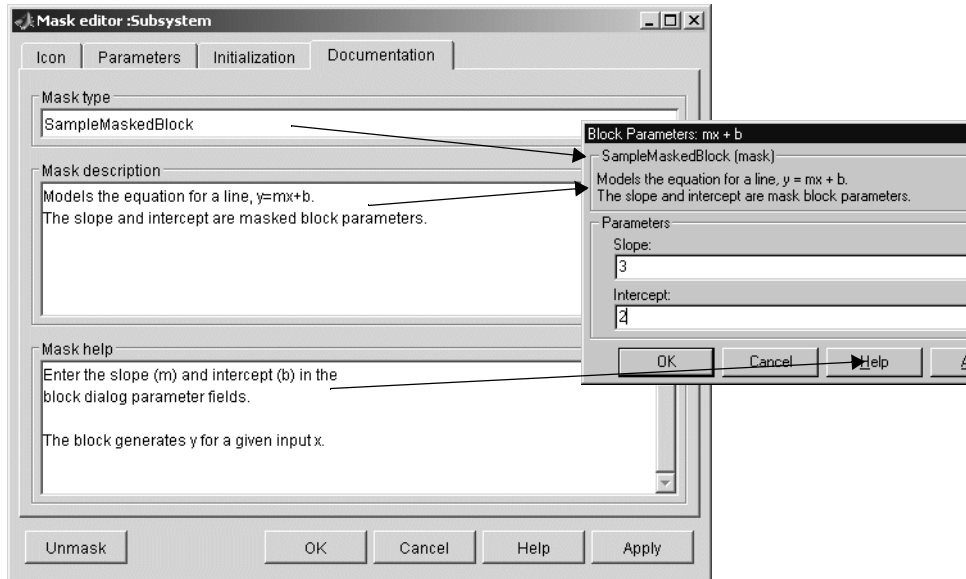

Creating the Block Icon

So far, we have created a customized dialog box for the $mx + b$ subsystem. However, the Subsystem block still displays the generic Simulink subsystem icon. An appropriate icon for this masked block is a plot that indicates the slope of the line. For a slope of 3, that icon looks like this.



The block icon is defined on the **Icon** pane. For this block, the **Icon** pane looks like this.

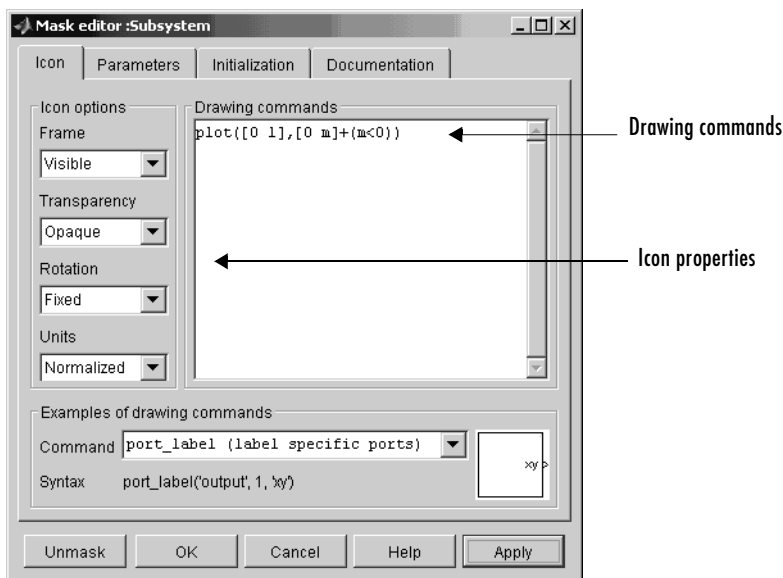

The drawing command plots a line from $(0,0)$ to $(1,m)$. If the slope is negative, Simulink shifts the line up by 1 to keep it within the visible drawing area of the block.

The drawing commands have access to all the variables in the mask workspace. As you enter different values of slope, the icon updates the slope of the plotted line.

Select **Normalized** as the **Drawing coordinates** parameter, located at the bottom of the list of icon properties, to specify that the icon be drawn in a frame whose bottom left corner is $(0,0)$ and whose top right corner is $(1,1)$. See “The Icon Pane” on page 12-14 for more information.

Masking a Subsystem

To mask a subsystem,

- 1 Select the subsystem.
- 2 Select **Edit mask** from the **Edit** menu of the model window or from the block's context menu. (Right-click the subsystem block to display its context menu.)

The Mask Editor appears.

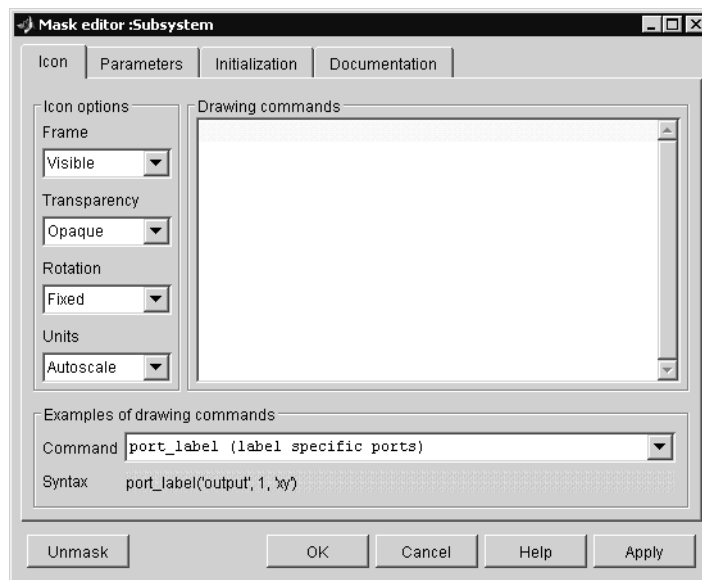

See “The Mask Editor” on page 12-12 for a detailed description of the Mask Editor.

- 3 Use the Mask Editor's tabbed panes to perform any of the following tasks.
 - Create a custom icon for the masked subsystem (see “The Icon Pane” on page 12-14)
 - Create parameters that allow a user to set subsystem options (see “The Mask Editor” on page 12-12)

- Initialize the masked subsystem's parameters
 - Create online user documentation for the subsystem
- 4** Click **Apply** to apply the mask to the subsystem or **OK** to apply the mask and dismiss the Mask Editor.

The Mask Editor

The Mask Editor allows you to create or edit a subsystem's mask. To open the Mask Editor, select the subsystem's block icon and then select **Edit Mask** from the **Edit** menu of the model window containing the subsystem's block. The Mask Editor appears.

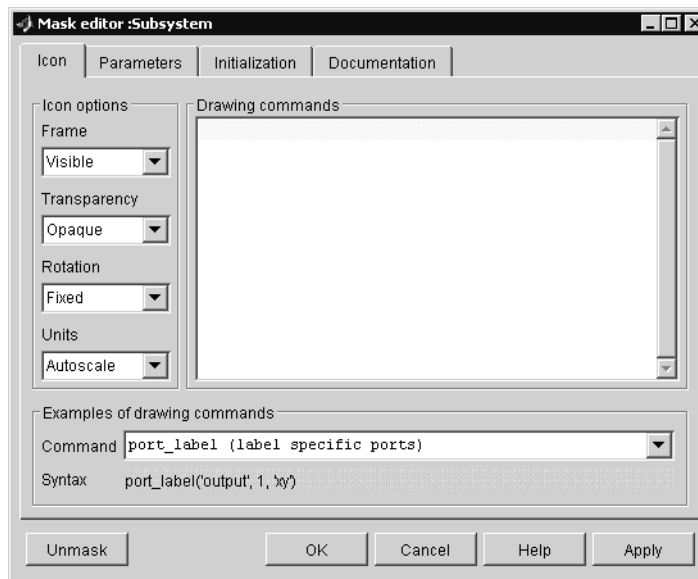

The Mask Editor contains a set of tabbed panes, each of which enables you to define a feature of the mask:

- The **Icon** pane enables you to define the block icon (see “The Icon Pane” on page 12-14).
- The **Parameters** pane enables you to define and describe mask dialog box parameter prompts and name the variables associated with the parameters (see “The Parameters Pane” on page 12-17).
- The **Initialization** pane enables you to specify initialization commands (see “The Initialization Pane” on page 12-23).
- The **Documentation** pane enables you to define the mask type and specify the block description and the block help (see “The Documentation Pane” on page 12-25).

Five buttons appear along the bottom of the Mask Editor:

- The **Unmask** button deactivates the mask and closes the Mask Editor. The mask information is retained so that the mask can be reactivated. To reactivate the mask, select the block and choose **Create Mask**. The Mask Editor opens, displaying the previous settings. The inactive mask information is discarded when the model is closed and cannot be recovered.
- The **OK** button applies the mask settings on all panes and closes the Mask Editor.
- The **Cancel** button closes the Mask Editor without applying any changes made since you last clicked the **Apply** button.
- The **Help** button displays the contents of this chapter.
- The **Apply** button creates or changes the mask using the information that appears on all masking panes. The Mask Editor remains open.

To see the system under the mask without unmasking it, select the Subsystem block, then choose **Look Under Mask** from the **Edit** menu. This command opens the subsystem. The block's mask is not affected.

The Icon Pane

The Mask Editor's **Icon** pane enables you to create icons that can contain descriptive text, state equations, images, and graphics.

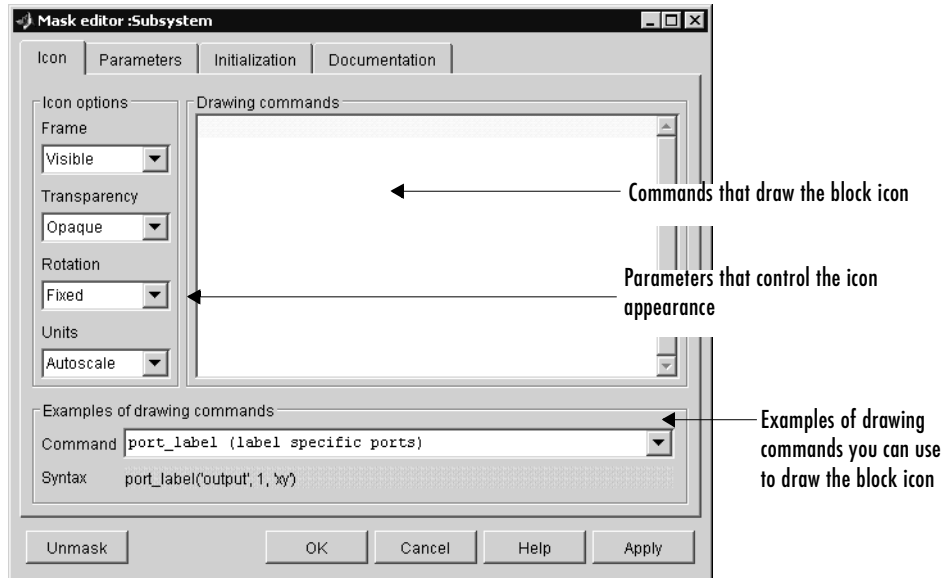

The **Icon** pane contains the following controls.

Drawing commands

This field allows you to enter commands that draw the block's icon. Simulink provides a set of commands that can display text, one or more plots, or show a transfer function (see "Mask Icon Drawing Commands") in the online Simulink reference). You must use these commands to draw your icon. Simulink executes the drawing commands in the order in which they appear in this field. Drawing commands have access to all variables in the mask workspace.

This example demonstrates how to create an improved icon for the $mx + b$ sample masked subsystem discussed earlier in this chapter.

```
pos = get_param(gcb, 'Position');
width = pos(3) - pos(1); height = pos(4) - pos(2);
x = [0, width];
if (m >= 0), y = [0, (m*width)]; end
```

```
if (m < 0), y = [height, (height + (m*width))]; end
```

These initialization commands define the data that enables the drawing command to produce an accurate icon regardless of the shape of the block. The drawing command that generates this icon is `plot(x,y)`.

Examples of drawing commands

This panel illustrates the usage of the various icon drawing commands supported by Simulink. To determine the syntax of a command, select the command from the **Command** list. Simulink displays an example of the selected command at the bottom of the panel and the icon produced by the command to the right of the list.

Icon options

These controls allow you to specify the following attributes of the block icon.

Frame. The icon frame is the rectangle that encloses the block. You can choose to show or hide the frame by setting the **Frame** parameter to **Visible** or **Invisible**. The default is to make the icon frame visible. For example, this figure shows visible and invisible icon frames for an AND gate block.

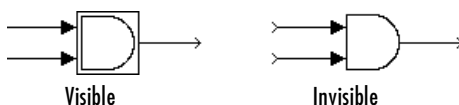

Transparency. The icon can be set to **Opaque** or **Transparent**, either hiding or showing what is underneath the icon. Opaque, the default, covers information Simulink draws, such as port labels. This figure shows opaque and transparent icons for an AND gate block. Notice the text on the transparent icon.

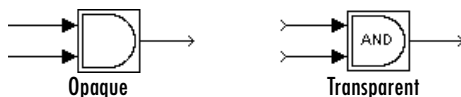

Rotation. When the block is rotated or flipped, you can choose whether to rotate or flip the icon or to have it remain fixed in its original orientation. The default is not to rotate the icon. The icon rotation is consistent with block port rotation. This figure shows the results of choosing **Fixed** and **Rotates** icon rotation when the AND gate block is rotated.



Units. This option controls the coordinate system used by the drawing commands. It applies only to plot and text drawing commands. You can select from among these choices: Autoscale, Normalized, and Pixel.

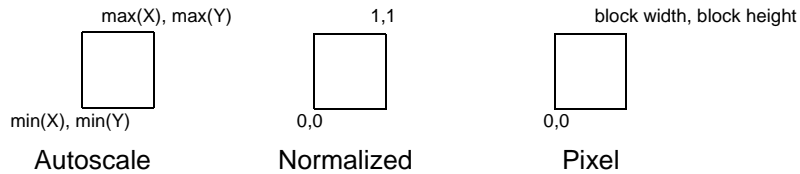

- Autoscale scales the icon to fit the block frame. When the block is resized, the icon is also resized. For example, this figure shows the icon drawn using these vectors:

$X = [0 \ 2 \ 3 \ 4 \ 9]; Y = [4 \ 6 \ 3 \ 5 \ 8];$



The lower left corner of the block frame is (0,3) and the upper right corner is (9,8). The range of the x -axis is 9 (from 0 to 9), while the range of the y -axis is 5 (from 3 to 8).

- Normalized draws the icon within a block frame whose bottom left corner is (0,0) and whose top right corner is (1,1). Only X and Y values between 0 and 1 appear. When the block is resized, the icon is also resized. For example, this figure shows the icon drawn using these vectors:

$X = [.0 \ .2 \ .3 \ .4 \ .9]; Y = [.4 \ .6 \ .3 \ .5 \ .8];$



- Pixel draws the icon with X and Y values expressed in pixels. The icon is not automatically resized when the block is resized. To force the icon to resize with the block, define the drawing commands in terms of the block size.

The Parameters Pane

The **Parameters** pane allows you to create and modify masked subsystem parameters (mask parameters, for short) that determine the behavior of the masked subsystem.

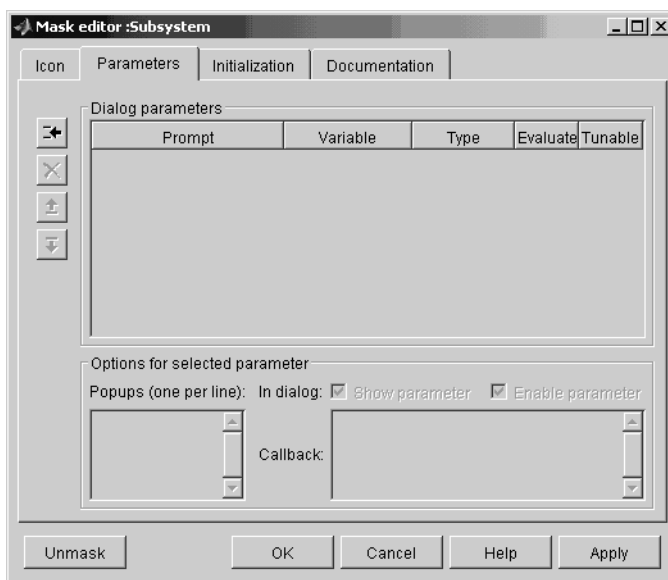

The **Parameters** pane contains the following elements:

- The **Dialog parameters** panel allows you to select and change the major properties of the mask's parameters (see "Dialog Parameters Panel" on page 12-18).
- The **Options for selected parameter** panel allows you to set additional options for the parameter selected in the **Dialog parameters** panel.
- The buttons on the left side of the **Parameters** pane allow you to add, delete, and change the order of appearance of parameters on the mask's parameter dialog box (see "Dialog Parameters Panel" on page 12-18).

Dialog Parameters Panel

Lists the mask's parameters in tabular form. Each row displays the major attributes of one of the mask's parameters.

Prompt. Text that identifies the parameter on a masked subsystem's dialog box.

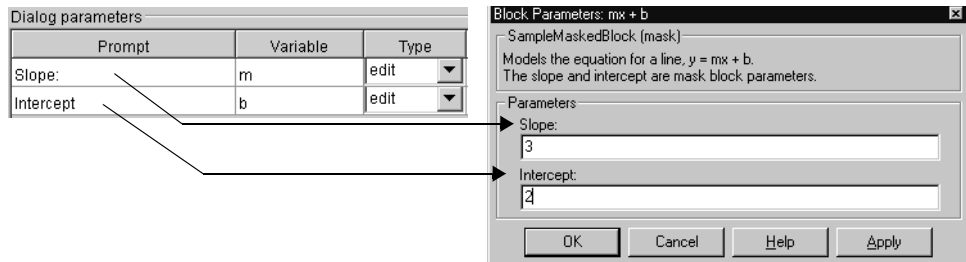

Variable. Name of the variable that stores the parameter's value in the mask's workspace (see "Mask Workspace" on page 12-4). You can use this variable as the value of parameters of blocks inside the masked subsystem, thereby allowing the user to set the parameters via the mask dialog box.

Note Simulink does not distinguish between uppercase and lowercase letters in mask variable names. For example, Simulink treats gain, GAIN, and Gain as the same name.

Type. Type of control used to edit the value of this parameter. The control appears on the mask's parameter dialog box following the parameter prompt. The button that follows the type name in the **Parameters** pane pops up a list of the controls supported by Simulink (see "Control Types" on page 12-20). To change the current control type, select another type from the list.

Evaluate. If checked, this option causes Simulink to evaluate the expression entered by the user before it is assigned to the variable. Otherwise, Simulink treats the expression itself as a string value and assigns it to the variable. For example, if the user enters the expression gain in an edit field and the **Evaluate** option is checked, Simulink evaluates gain and assigns the result to the variable. Otherwise, Simulink assigns the string 'gain' to the variable.

See “Check Box Control” on page 12-21 and “Pop-Up Control” on page 12-22 for information on how this option affects evaluation of the parameters.

If you need both the string entered and the evaluated value, uncheck the **Evaluate** option. Then use the MATLAB `eval` command in the initialization commands. For example, if `LitVal` is the string 'gain', then to obtain the evaluated value, use the command

```
value = eval(LitVal)
```

Tunable. Selecting this option allows a user to change the value of the mask parameter while a simulation is running.

Options for Selected Parameter Panel

This panel allows you to set additional options for the parameter selected in the **Dialog parameters** table.

Show parameter. The selected parameter appears on the masked block’s parameter dialog box only if this option is checked (the default).

Enable parameter. Unchecking this option grays the selected parameter’s prompt and disables its edit control. This means that the user cannot set the value of the parameter.

Popups. This field is enabled only if the edit control for the selected parameter is a pop-up. Enter the values of the pop-up control in this field, each on a separate line.

Callback. Enter MATLAB code that you want Simulink to execute when a user edits the selected parameter. The callback can create and reference variables only in the block’s base workspace. If the callback needs the value of a mask parameter, it can use `get_param` to obtain the value, e.g.,

```
if str2num(get_param(gcf, 'g'))<0
    error('Gain is negative.')
end
```

Parameter Buttons

The following sections explain the purpose of the buttons that appear on the **Parameters** pane in the order of their appearance from the top of the pane.

Add Button. Adds a parameter to the mask’s parameter list. The newly created parameter appears in the adjacent **Dialog parameters** table.

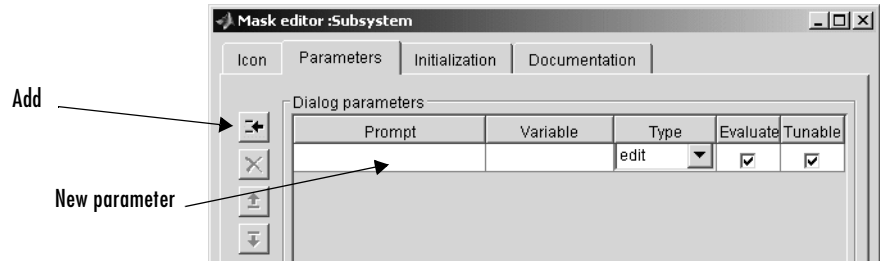

Delete Button. Deletes the parameter currently selected in the **Dialog parameters** table.

Up Button. Moves the currently selected parameter up one row in the **Dialog parameters** table. Dialog parameters appear in the mask’s parameter dialog box (see “Mask Parameter Dialog Box” on page 12-3) in the same order in which they appear in the **Dialog parameters** table. This button (and the next) thus allows you to determine the order in which parameters appear on the dialog box.

Down Button. Moves the currently selected parameter down one row in the **Dialog parameters** table and hence down one position on the mask’s parameter dialog box.

Control Types

Simulink enables you to choose how parameter values are entered or selected. You can create three styles of controls: edit fields, check boxes, and pop-up controls. For example, this figure shows the parameter area of a mask dialog box that uses all three styles of controls (with the pop-up control open).

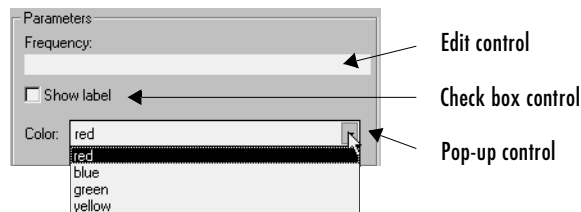

Edit Control

An *edit field* enables the user to enter a parameter value by typing it into a field. This figure shows how the prompt for the sample edit control was defined.

Prompt	Variable	Type	Evaluate	Tunable
Slope:	m	edit	<input checked="" type="checkbox"/>	<input checked="" type="checkbox"/>
Intercept	b	edit	<input checked="" type="checkbox"/>	<input checked="" type="checkbox"/>

The value of the variable associated with the parameter is determined by the **Evaluate** option.

Evaluate	Value
On	The result of evaluating the expression entered in the field
Off	The actual string entered in the field

Check Box Control

A *check box* enables the user to choose between two alternatives by selecting or deselecting a check box. This figure shows how the sample check box control is defined.

Prompt	Variable	Type	Evaluate	Tunable
Saturate	sat	checkbox	<input checked="" type="checkbox"/>	<input checked="" type="checkbox"/>

The value of the variable associated with the parameter depends on whether the **Evaluate** option is selected.

Control State	Evaluated Value	Literal Value
Checked	1	'on'
Unchecked	0	'off'

Pop-Up Control

A *pop-up* enables the user to choose a parameter value from a list of possible values. Specify the values in the **Popups** field on the **Parameters** pane (see “Popups” on page 12-19). The following example shows a pop-up parameter.

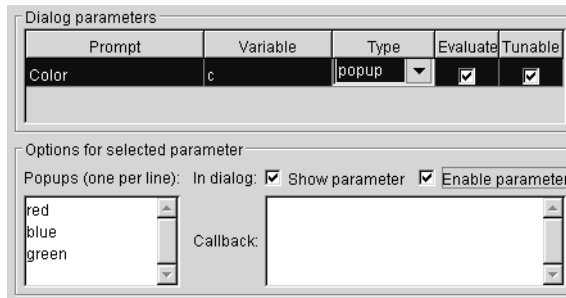

The value of the variable associated with the parameter (Color) depends on the item selected from the pop-up list and whether the **Evaluate** option is checked (on).

Evaluate	Value
On	Index of the value selected from the list, starting with 1. For example, if the third item is selected, the parameter value is 3.
Off	String that is the value selected. If the third item is selected, the parameter value is 'green'.

Changing Default Values for Mask Parameters in a Library

To change default parameter values in a masked library block, follow these steps:

- 1 Unlock the library.
- 2 Open the block to access its dialog box, fill in the desired default values, and close the dialog box.
- 3 Save the library.

When the block is copied into a model and opened, the default values appear on the block's dialog box.

For more information, see “Working with Block Libraries” on page 5-29.

The Initialization Pane

The **Initialization** pane allows you to enter MATLAB commands that initialize the masked subsystem.

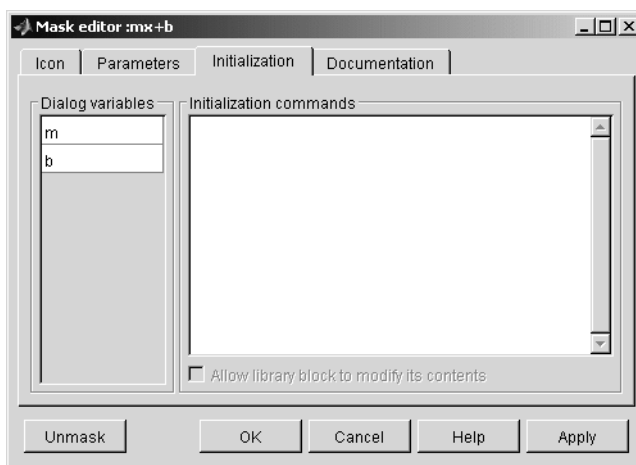

Simulink executes the initialization commands when it

- Loads the model
- Starts the simulation or updates the block diagram
- Rotates the masked block
- Redraws the block's icon (if the mask's icon creation code depends on variables defined in the initialization code)

The **Initialization** pane includes the following controls.

Dialog variables

The **Dialog variables** list displays the names of the variables associated with the subsystem's mask parameters, i.e., the parameters defined in the **Parameters** pane. You can copy the name of a parameter from this list and

paste it into the adjacent **Initialization commands** field, using the Simulink keyboard copy and paste commands. You can also use the list to change the names of mask parameter variables. To change a name, double-click the name in the list. An edit field containing the existing name appears. Edit the existing name and press **Enter** or click outside the edit field to confirm your changes.

Initialization commands

Enter the initialization commands in this field. You can enter any valid MATLAB expression, consisting of MATLAB functions, operators, and variables defined in the mask workspace. Initialization commands cannot access base workspace variables. Terminate initialization commands with a semicolon to avoid echoing results to the Command Window.

Allow library block to modify its contents

This check box is enabled only if the masked subsystem resides in a library. Checking this block allows the block's initialization code to modify the contents of the masked subsystem, i.e., it lets the code add or delete blocks and set the parameters of those blocks. Otherwise, Simulink generates an error when a masked library block tries to modify its contents in any way. To set this option at the MATLAB prompt, select the self-modifying block and enter the following command.

```
set_param(gcf, 'MaskSelfModifiable', 'on');
```

Then save the block.

Debugging Initialization Commands

You can debug initialization commands in these ways:

- Specify an initialization command without a terminating semicolon to echo its results to the Command Window.
- Place a keyboard command in the initialization commands to stop execution and give control to the keyboard. For more information, see the help text for the keyboard command.
- Enter either of these commands in the MATLAB Command Window:

```
dbstop if error
```



```
dbstop if warning
```

If an error occurs in the initialization commands, execution stops and you can examine the mask workspace. For more information, see the help text for the `dbstop` command.

The Documentation Pane

The **Documentation** pane enables you to define or modify the type, description, and help text for a masked block. This figure shows how fields on the **Documentation** pane correspond to the $mx + b$ sample mask block's dialog box.

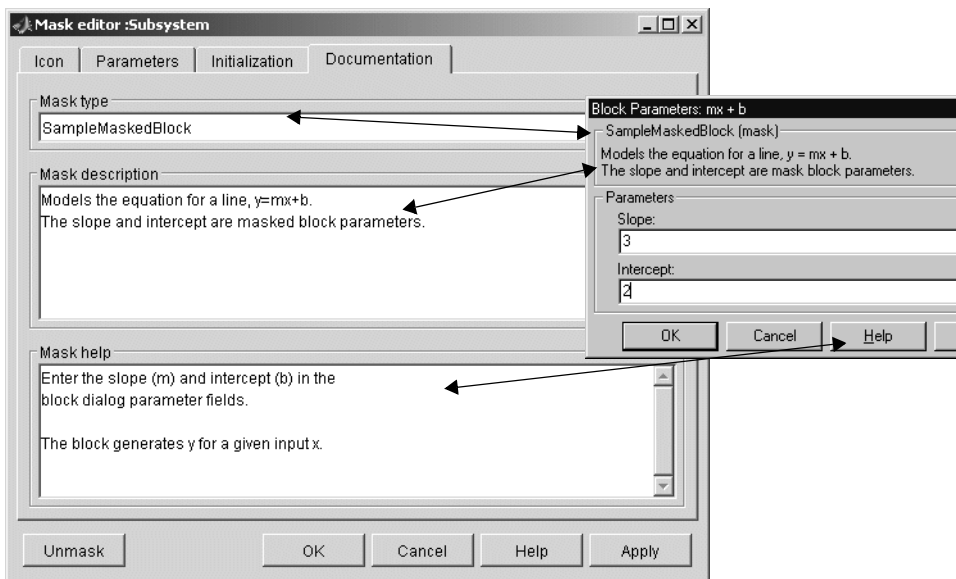

Mask Type Field

The mask type is a block classification used only for purposes of documentation. It appears in the block's dialog box and on all Mask Editor panes for the block. You can choose any name you want for the mask type. When Simulink creates the block's dialog box, it adds "(mask)" after the mask type to differentiate masked blocks from built-in blocks.

Mask Description Field

The block description is informative text that appears in the block's dialog box in the frame under the mask type. If you are designing a system for others to use, this is a good place to describe the block's purpose or function.

Simulink automatically wraps long lines of text. You can force line breaks by using the **Enter** or **Return** key.

Block Help Field

You can provide help text that is displayed when the **Help** button is clicked on the masked block's dialog box. If you create models for others to use, this is a good place to explain how the block works and how to enter its parameters.

You can include user-written documentation for a masked block's help. You can specify any of the following for the masked block help text:

- URL specification (a string starting with `http:`, `www`, `file:`, `ftp:`, or `mailto:`)
- web command (launches a browser)
- eval command (evaluates a MATLAB string)
- HTML-tagged text to be displayed in a Web browser

Simulink examines the first line of the masked block help text. If Simulink detects a URL specification, for example,

```
http://www.mathworks.com
```

or

```
file:///c:/mydir/helpdoc.html
```

Simulink displays the specified file in the browser. If Simulink detects a web command, for example,

```
web([docroot '/My Blockset Doc/' get_param(gcb,'MaskType')...  
' .html'])
```

or an eval command, for example,

```
eval('!Word My_Spec.doc')
```

Simulink executes the specified command. Otherwise, Simulink displays the contents of the **Block Help** field, which can include HTML tags, in the browser.

Linking Mask Parameters to Block Parameters

The variables associated with mask parameters allow you to link mask parameters with block parameters. This in turn allows a user to use the mask to set the values of parameters of blocks inside the masked subsystem.

To link the parameters, open the block's parameter dialog box and enter an expression in the block parameter's value field that uses the mask parameter. The $mx + b$ masked subsystem, described earlier in this chapter, uses this approach to link the Slope and Intercept mask parameters to corresponding parameters of a Gain and Constant block, respectively, that reside in the subsystem.

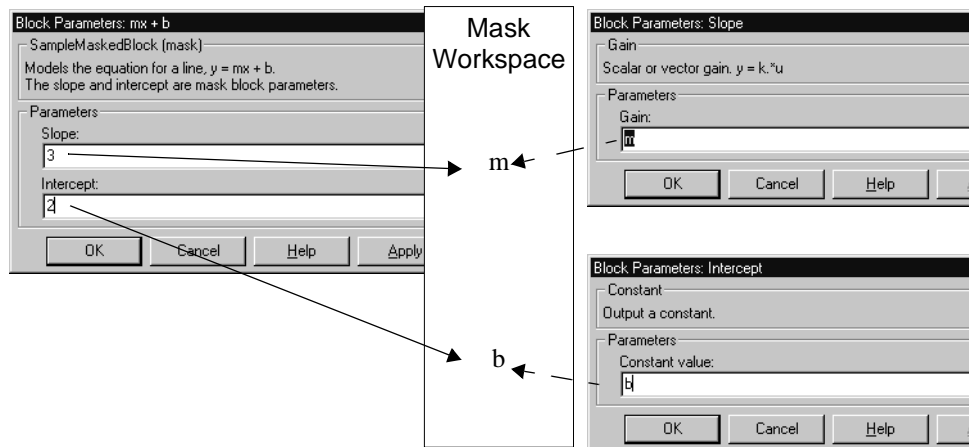

You can use a masked block's initialization code to link mask parameters indirectly to block parameters. In this approach, the initialization code creates variables in the mask workspace whose values are functions of the mask parameters and that appear in expressions that set the values of parameters of blocks concealed by the mask.

Creating Dynamic Dialogs for Masked Blocks

Simulink allows you to create dialogs for masked blocks whose appearance changes in response to user input. Features of masked dialog boxes that can change in this way include

- Visibility of parameter controls
Changing a parameter can cause the control for another parameter to appear or disappear. The dialog expands or shrinks when a control appears or disappears, respectively.
- Enabled state of parameter controls
Changing a parameter can cause the control for another parameter to be enabled or disabled for input. Simulink grays a disabled control to indicate visually that it is disabled.
- Parameter values
Changing a parameter can cause related parameters to be set to appropriate values.

Creating a dynamic masked dialog entails using the mask editor in combination with the Simulink `set_param` command. Specifically, you first use the mask editor to define all the dialog's parameters, both static and dynamic. Next, you use the Simulink `set_param` command at the MATLAB command line to specify callback functions that define the dialog's response to user input. Finally, you save the model or library containing the masked subsystem to complete the creation of the dynamic masked dialog.

Setting Masked Block Dialog Parameters

Simulink defines a set of masked block parameters that define the current state of the masked block's dialog. You can use the mask editor to inspect and set many of these parameters. The Simulink `get_param` and `set_param` commands also let you inspect and set mask dialog parameters. The advantage? The `set_param` command allows you to set parameters and hence change a dialog's appearance while the dialog is open. This in turn allows you to create dynamic masked dialogs.

For example, you can use the `set_param` command at the MATLAB command line to specify callback functions to be invoked when a user changes the values of user-defined parameters. The callback functions in turn can use `set_param`

commands to change the values of the masked dialog's predefined parameters and hence its state, for example, to hide, show, enable, or disable a user-defined parameter control.

Predefined Masked Dialog Parameters

Simulink associates the following predefined parameters with masked dialogs.

MaskCallbacks

The value of this parameter is a cell array of strings that specify callback expressions for the dialog's user-defined parameter controls. The first cell defines the callback for the first parameter's control, the second for the second parameter control, etc. The callbacks can be any valid MATLAB expressions, including expressions that invoke M-file commands. This means that you can implement complex callbacks as M-files.

The easiest way to set callbacks for a mask dialog is to first select the corresponding masked dialog in a model or library window and then to issue a `set_param` command at the MATLAB command line. For example, the following code

```
set_param(gcf, 'MaskCallbacks', {'parm1_callback', '', ...  
    'parm3_callback'});
```

defines callbacks for the first and third parameters of the masked dialog for the currently selected block. To save the callback settings, save the model or library containing the masked block.

MaskDescription

The value of this parameter is a string specifying the description of this block. You can change a masked block's description dynamically by setting this parameter.

MaskEnables

The value of this parameter is a cell array of strings that define the enabled state of the user-defined parameter controls for this dialog. The first cell defines the enabled state of the control for the first parameter, the second for the second parameter, etc. A value of 'on' indicates that the corresponding control is enabled for user input; a value of 'off' indicates that the control is disabled.

You can enable or disable user input dynamically by setting this parameter in a callback. For example, the following command in a callback

```
set_param(gcf,'MaskEnables',{'on','on','off'});
```

would disable the third control of the currently open masked block's dialog. Simulink colors disabled controls gray to indicate visually that they are disabled.

MaskPrompts

The value of this parameter is a cell array of strings that specify prompts for user-defined parameters. The first cell defines the prompt for the first parameter, the second for the second parameter, etc.

MaskType

The value of this parameter is the mask type of the block associated with this dialog.

MaskValues

The value of this parameter is a cell array of strings that specify the values of user-defined parameters for this dialog. The first cell defines the value for the first parameter, the second for the second parameter, etc.

MaskVisibilities

The value of this parameter is a cell array of strings that specify the visibility of the user-defined parameter controls for this dialog. The first cell defines the visibility of the control for the first parameter, the second for the second parameter, etc. A value of 'on' indicates that the corresponding control is visible; a value of 'off' indicates that the control is hidden.

You can hide or show user-defined parameter controls dynamically by setting this parameter in the callback for a control. For example, the following command in a callback

```
set_param(gcf,'MaskVisibilities',{'on','off','on'});
```

would hide the control for the currently selected block's second user-defined mask parameter. Simulink expands or shrinks a dialog to show or hide a control, respectively.

Simulink Debugger

The following sections tell you how to use the Simulink debugger to pinpoint bugs in a model.

Introduction (p. 13-2)	Overview of the debugger.
Using the Debugger's Graphical User Interface (p. 13-3)	How to use the debugger's graphical user interface.
Using the Debugger's Command-Line Interface (p. 13-11)	How to debug from the MATLAB command line.
Getting Online Help (p. 13-12)	How to get help on debugger commands.
Starting the Debugger (p. 13-13)	How to start a simulation from the debugger.
Starting a Simulation (p. 13-14)	How to start a simulation in debug mode.
Running a Simulation Step by Step (p. 13-15)	How to run a simulation step by step.
Setting Breakpoints (p. 13-22)	How to set breakpoints at blocks and time steps.
Displaying Information About the Simulation (p. 13-28)	How to display information about the current simulation.
Displaying Information About the Model (p. 13-32)	How to display information about the model being debugged.

Introduction

The Simulink debugger allows you to run a simulation method by method, stopping the simulation after each method, to examine the results of executing that method. This allows you to pinpoint problems in your model to specific blocks, parameters, or interconnections.

Note Methods are functions that Simulink uses to solve a model at each time step during the simulation. Blocks are made up of multiple methods. “Block execution” in this documentation is shorthand notation for “block methods execution.” Block diagram execution is a multi-step operation that requires execution of the different block methods in all the blocks in a diagram at various points during the process of solving a model at each time step during simulation, as specified by the simulation loop.

The Simulink debugger has both a graphical and a command-line user interface. The graphical interface allows you to access the debugger’s most commonly used features. The command-line interface gives you access to all the debugger’s capabilities. If both interfaces enable you to perform a task, the documentation shows you first how to use the graphical interface, then the command-line interface, to perform the task.

Using the Debugger's Graphical User Interface

Select **Debug** from a model window's **Tools** menu to display the Simulink debugger's graphical interface.

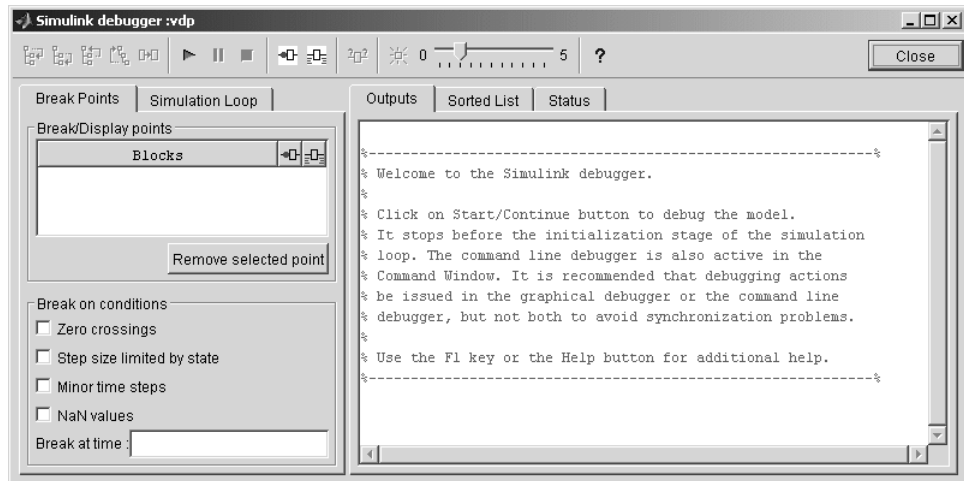

The following topics describe the major components of the debugger's graphical user interface:





- "Toolbar" on page 13-4
- "Breakpoints Pane" on page 13-6
- "Simulation Loop Pane" on page 13-7
- "Outputs Pane" on page 13-8
- "Sorted List Pane" on page 13-9
- "Status Pane" on page 13-10

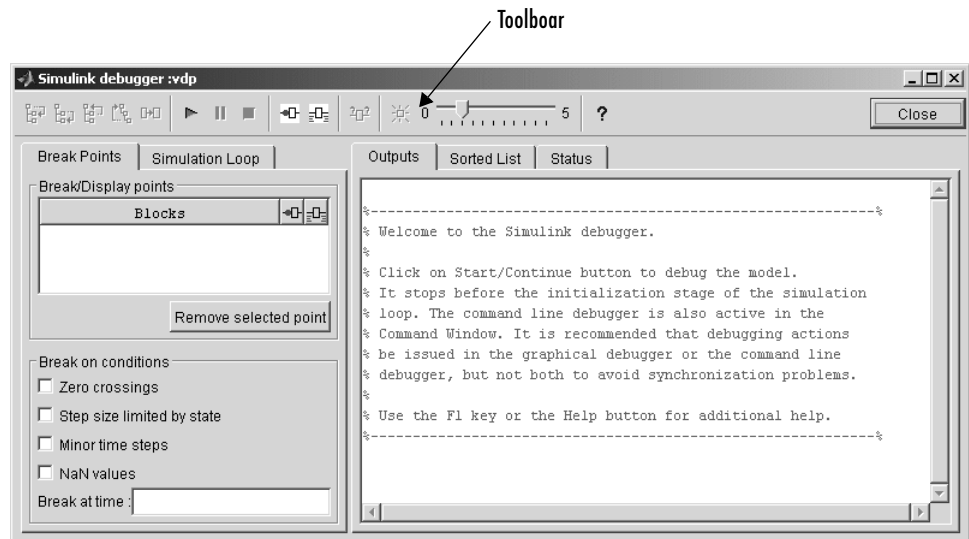







Toolbar

The debugger toolbar appears at the top of the debugger window.



From left to right, the toolbar contains the following command buttons:

Button	Purpose
	Step into next method (see “Stepping Commands” on page 13-17 for more information on this and the following stepping commands).
	Step over next method.
	Step out of current method.
	Step to first method at start of next time step.
	Step to next block method.

Button	Purpose
	Start or continue the simulation.
	Pause the simulation.
	Stop the simulation.
	Break before the selected block.
	Display inputs and outputs of the selected block when executed.
	Display current inputs and outputs of selected block.
	Toggle animation mode on or off (see “Animation Mode” on page 13-18). The slider next to this button controls the animation rate.
	Display help for the debugger.
	Close the debugger.

Breakpoints Pane

To display the **Breakpoints** pane, select the **Break Points** tab on the debugger window.

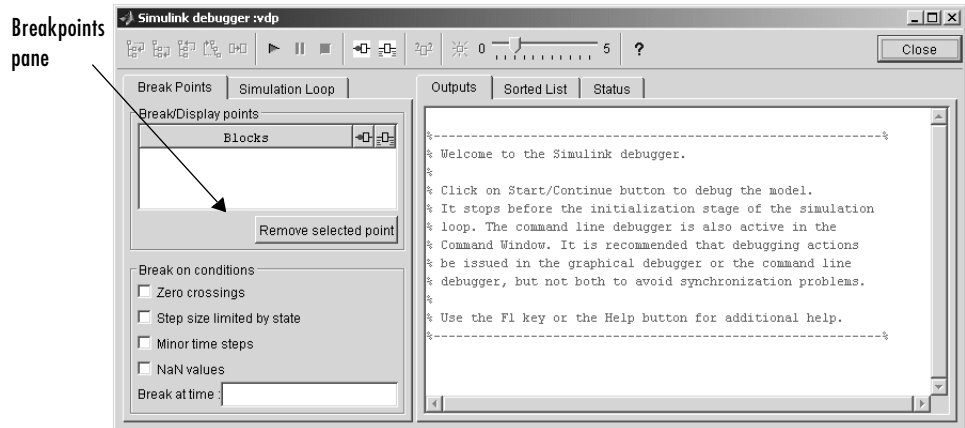

The **Breakpoints** pane allows you to specify block methods or conditions at which to stop a simulation. See “Setting Breakpoints” on page 13–22 for more information.

Note The debugger grays out and disables the **Breakpoints** pane when its animation mode is selected (see “Animation Mode” on page 13-18). This prevents you from setting breakpoints and indicates that animation mode ignores existing breakpoints.

Simulation Loop Pane

To display the **Simulation Loop** pane, select the **Simulation Loop** tab on the debugger window.

Simulation Loop pane

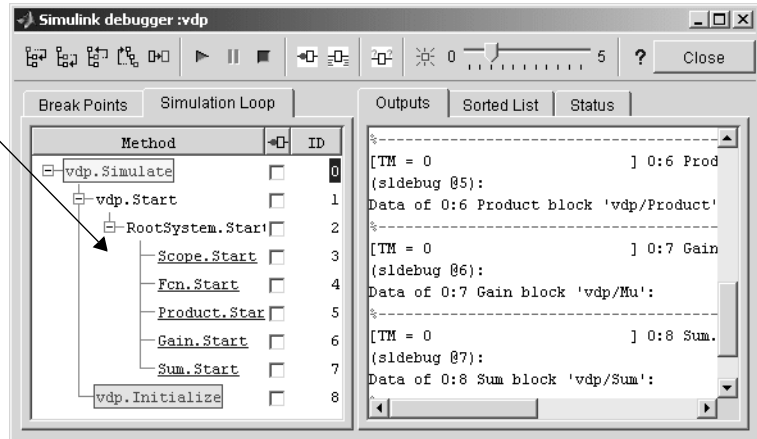

The Simulation Loop pane contains three columns:

- Method
- Breakpoints
- ID

Method Column

The **Method** column lists the methods that have been called thus far in the simulation as a method tree with expandable/collapsible nodes. Each node of the tree represents a method that calls other methods. Expanding a node shows the methods that the block method calls. Block method names are hyperlinks. Clicking a block method name highlights the corresponding block in the model diagram. Block method names are underlined to indicate that they are hyperlinks.

Whenever the simulation stops, the debugger highlights the name of the method where the simulation has stopped as well as the methods that directly or indirectly invoked it. The highlighted method names visually indicate the current state of the simulator's method call stack.

Breakpoints Column

The breakpoints column consists of check boxes. Selecting a check box sets a breakpoint at the method whose name appears to the left of the check box. See “Setting Breakpoints from the Simulation Loop Pane” on page 13-24 for more information.

Note The debugger grays out and disables this column when its animation mode is selected (see “Animation Mode” on page 13-18). This prevents you from setting breakpoints and indicates that animation mode ignores existing breakpoints.

ID Column

The ID column lists the IDs of the methods listed in the **Methods** column. See “Method ID” on page 13-11 for more information.

Outputs Pane

To display the **Outputs** pane, select the **Outputs** tab on the debugger window.

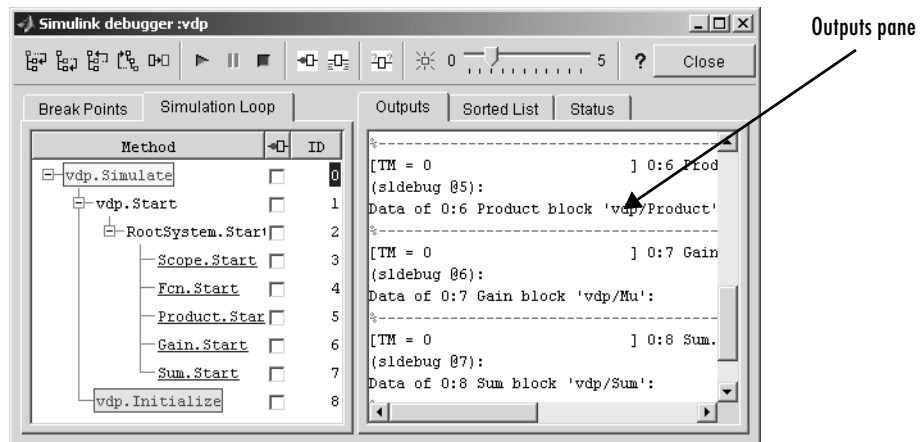

The Outputs pane displays the same debugger output that would appear in the MATLAB Command Window, if the debugger were running in command-line mode. The output includes the debugger command prompt and the inputs,

outputs, and states of the block at whose method the simulation is currently paused (see “Block Data Output” on page 13-16). The command prompt displays current simulation time and the name and index of the method in which the debugger is currently stopped (see “Block ID” on page 13-11).

Sorted List Pane

To display the **Sorted List** pane, select the **Sorted List** tab on the debugger window.

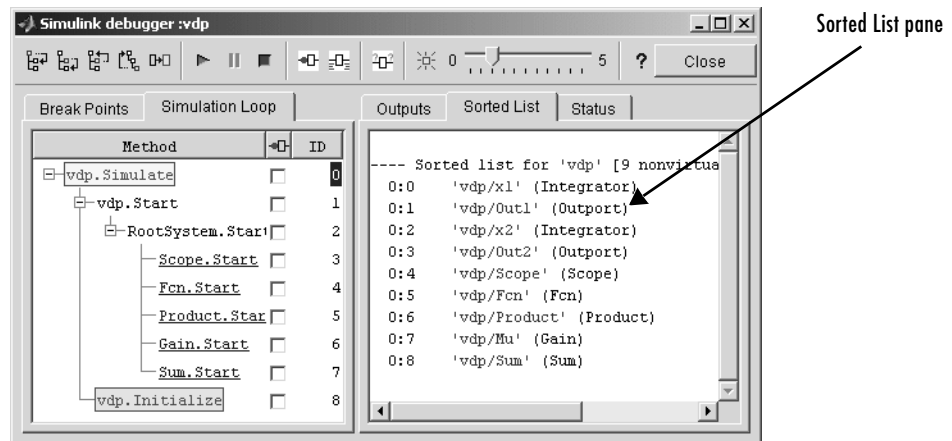

The **Sorted List** pane displays the sorted lists for the model being debugged. See “Displaying a Model’s Sorted Lists” on page 13-32 for more information.

Status Pane

To display the **Status** pane, select the **Status** tab on the debugger window.

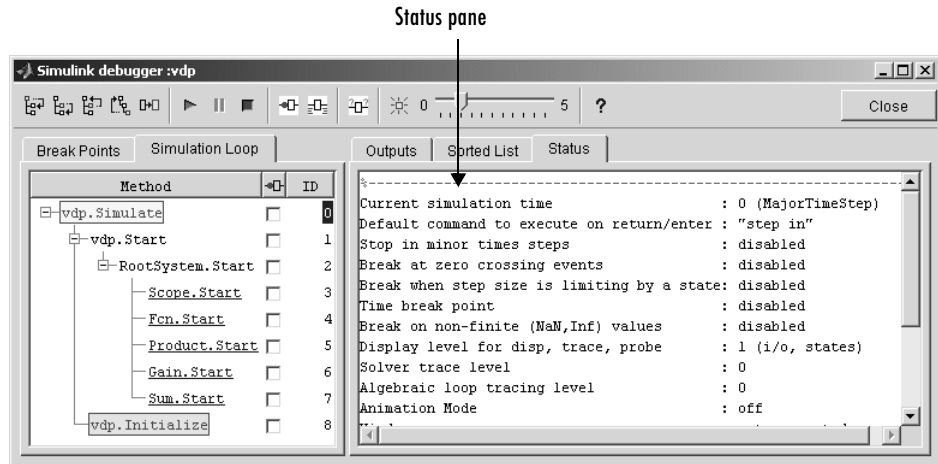

The **Status** pane displays the values of various debugger options and other status information.

Using the Debugger's Command-Line Interface

In command-line mode, you control the debugger by entering commands at the debugger command line in the MATLAB Command Window. The debugger accepts abbreviations for debugger commands. See the Simulink Reference for a list of command abbreviations and repeatable commands. You can repeat some commands by entering an empty command (i.e., by pressing the **Enter** key) at the MATLAB command line.

Method ID

Some Simulink commands and messages use method IDs to refer to methods. A method ID is an integer assigned to a method the first time it is invoked in a simulation. The debugger assigns method indexes sequentially, starting with 0 for the first method invoked in a debugger session.

Block ID

Some Simulink debugger commands and messages use block IDs to refer to blocks. Simulink assigns block IDs to blocks while generating the model's sorted lists during the compilation phase of the simulation. A block ID has the form `sid:bid` where `sid` is an integer identifying the system that contains the block (either the root system or a nonvirtual subsystem) and `bid` is the position of the block in the system's sorted list. For example, the block index `0:1` refers to the first block in the model's root system. The `slist` command shows the block ID for each block in the model being debugged.

Accessing the MATLAB Workspace

You can enter any MATLAB expression at the `sldebug` prompt. For example, suppose you are at a breakpoint and you are logging time and output of your model as `tout` and `yout`. Then the following command

```
(sldebug ...) plot(tout, yout)
```

creates a plot. You cannot display the value of a workspace variable whose name is partially or entirely the same as that of a debugger command by entering it at the debugger command prompt. You can, however, use the MATLAB `eval` command to work around this problem. For example, use `eval('s')` to determine the value of `s` rather than `s(tep)` the simulation.

Getting Online Help

You can get online help on using the debugger by clicking the **Help** button on the debugger's toolbar or by pressing the **F1** key when the text cursor is in a debugger panel or text field. Clicking the Help button displays help for the debugger in the MATLAB Help browser.

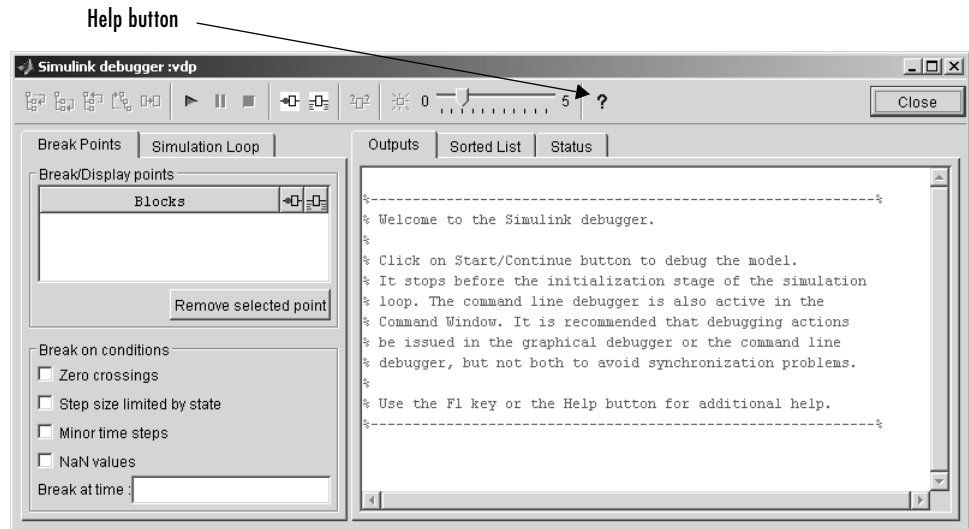

Pressing the **F1** key displays help for the debugger panel or text field that currently has the keyboard input focus. In command-line mode, you can get a brief description of the debugger commands by typing `help` at the debug prompt.

Starting the Debugger

You can start the debugger either from a model window or from the MATLAB command line. To start the debugger from a model window, select **Debugger** from the model window's **Tools** menu. The debugger's graphical user interface appears (see "Using the Debugger's Graphical User Interface" on page 13–3).

To start the debugger from the MATLAB Command Window, enter either the `sldebug` command or a `sim` command. For example, either the command

```
sim('vdp',[0,10],simset('debug','on'))
```

or the command

```
sldebug 'vdp'
```

loads the Simulink demo model `vdp` into memory, starts the simulation, and stops the simulation at the first block in the model's execution list.

Note When running the debugger in graphical user interface (GUI) mode, you must explicitly start the simulation. See "Starting the Debugger" on page 13-13 for more information.

Starting a Simulation

To start the simulation, click the Start/Continue button on the debugger's toolbar.

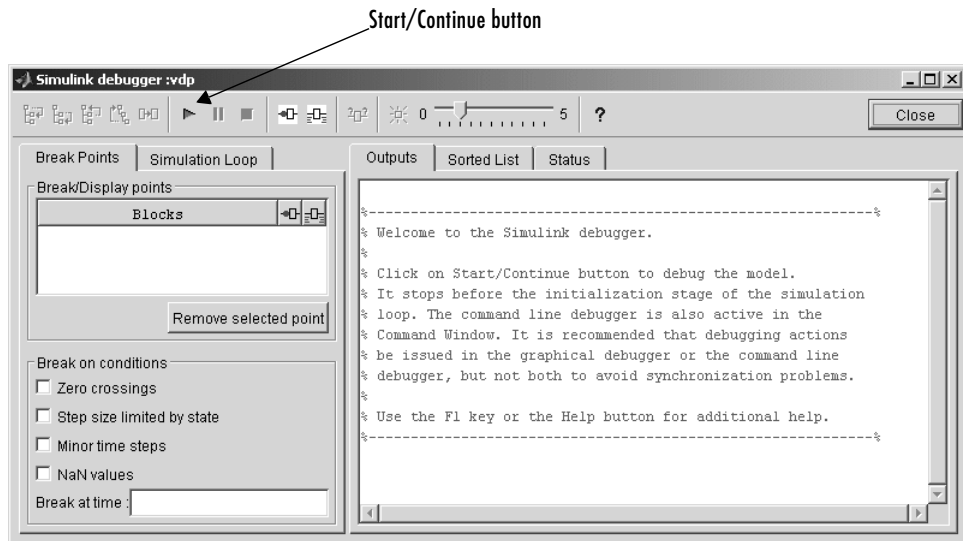

The simulation starts and stops at the first simulation method to be executed. It displays the name of the method in its **Simulation Loop** pane and in the current method annotation on the Simulink block diagram. At this point, you can set breakpoints, run the simulation step by step, continue the simulation to the next breakpoint or end, examine data, or perform other debugging tasks. The following sections explain how to use the debugger's graphical controls to perform these debugging tasks.

Note When you start the debugger in GUI mode, the debugger's command-line interface is also active in the MATLAB Command Window. However, you should avoid using the command-line interface, to prevent synchronization errors between the graphical and command-line interfaces.

Running a Simulation Step by Step

The Simulink debugger provides various commands that let you advance a simulation from the method where it is currently suspended (the next method) by various increments (see “Stepping Commands” on page 13-17). For example, you can advance the simulation into or over the next method, or out of the current method, or to the top of the simulation loop. After each advance, the debugger displays information that enables you to determine the point to which the simulation has advanced and the results of advancing the simulation to that point.

For example, in GUI mode, after each step command, the debugger highlights the current method call stack in the **Simulation Loop** pane. The call stack comprises the next method and the methods that invoked the next method either directly or indirectly. The debugger highlights the call stack by highlighting the names of the methods that make up the call stack in the **Simulation Loop** pane.

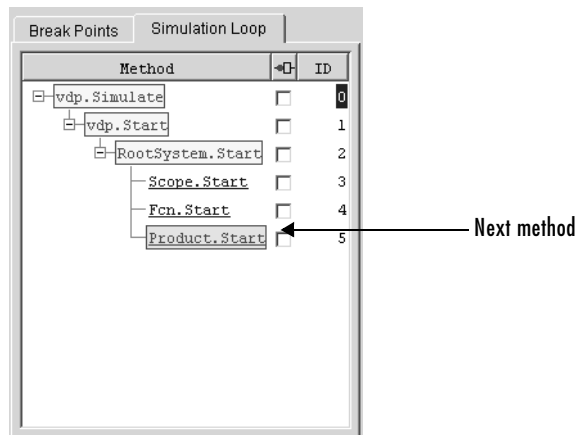

In command-line mode, you can use the `where` command to display the method call stack. If the next method is a block method, the debugger points the debug pointer at the block corresponding to the method (see “Debug Pointer” on page 13-20 for more information). If the block of the next method to be executed resides in a subsystem, the debugger opens the subsystem and points to the block in the subsystem’s block diagram.

Block Data Output

After executing a block method, the debugger prints any or all of the following block data in the debugger Output panel (in GUI mode) or in the MATLAB Command Window (in command-line mode):

- $U_n = v$
where v is the current value of the block's n th input.
- $Y_n = v$
where v is the current value of the block's n th output.
- $CSTATE = v$
where v is the value of the block's continuous state vector.
- $DSTATE = v$
where v is the value of the blocks discrete state vector.

The debugger also displays the current time, the ID and name of the next method to be executed, and the name of the block to which the method applies in the MATLAB Command Window. The following example illustrates typical debugger outputs after a step command.

```

                                Current time   Next method
                                ↙             ↘
%-----%
[Tm = 2.009509145207664e-005 ] 0:2 Integrator.Outputs 'vdp/x2'
(sldebug @44):
Data of 0:2 Integrator block 'vdp/x2':
U1      = [-2]
Y1      = [-4.0190182904153282e-005]
CSTATE  = [-4.0190182904153282e-005]
%-----%
[Tm = 2.009509145207664e-005 ] 0:3 Outport.Outputs 'vdp/Out2'

```

Stepping Commands

Command-line mode provides the following commands for advancing a simulation incrementally:

Command	Advances the simulation...
<code>step [in into]</code>	Into the next method, stopping at the first method in the next method or, if the next method does not contain any methods, at the end of the next method
<code>step over</code>	To the method that follows the next method, executing all methods invoked directly or indirectly by the next method
<code>step out</code>	To the end of the current method, executing any remaining methods invoked by the current method
<code>step top</code>	To the first method of the next time step (i.e., the top of the simulation loop)
<code>step blockmth</code>	To the next block method to be executed, executing all intervening model- and system-level methods
<code>next</code>	Same as <code>step over</code>

Buttons in the debugger toolbar allow you to access these commands in GUI mode.



Clicking a button has the same effect as entering the corresponding command at the debugger command line.

Continuing a Simulation

In GUI mode, the Stop button turns red when the debugger suspends the simulation for any reason. To continue the simulation, click the Start/Continue button. In command-line mode, enter `continue` to continue the simulation. By default, the debugger runs the simulation to the next breakpoint (see “Setting Breakpoints” on page 13-22) or to the end of the simulation, whichever comes first.

Animation Mode

In *animation mode*, the Start/Continue button or the `continue` command advances the simulation method by method, pausing after each method, to the first method of the next major time step. While running the simulation in animation mode, the debugger uses its debug pointer (see “Debug Pointer” on page 13-20) to indicate on the block diagram which block method is being executed at each step. The moving pointer providing a visual indication of the progress of the simulation.

Note When animation mode is enabled, the debugger does not allow you to set breakpoints and ignores any breakpoints that you set when animating the simulation.

To enable animation when running the debugger in GUI mode, click the Animation Mode toggle button on the debugger’s toolbar.

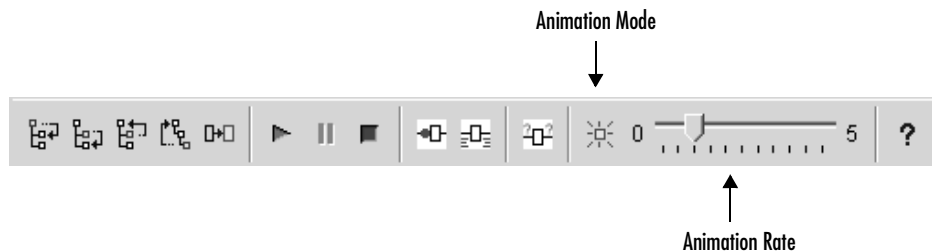

The slider on the debugger toolbar allows you to increase or decrease the delay between method invocations and hence to slow down or speed up the animation rate. To disable animation mode when running the debugger in GUI mode, toggle the Animation Mode button on the toolbar.

To enable animation when running the debugger in command-line mode, enter the `animate` command at the MATLAB command line. The `animate` command's optional delay parameter allows you to specify the length of the pause between method invocations (1 second by default) and thereby accelerate or slow down the animation. For example, the command

```
animate 0.5
```

causes the animation to run at twice its default rate. To disable animation mode when running the debugger in command-line mode, enter

```
animate stop
```

at the MATLAB command line.

Running a Simulation Nonstop

The `run` command lets you run a simulation to the end of the simulation, skipping any intervening breakpoints. At the end of the simulation, the debugger returns you to the MATLAB command line. To continue debugging a model, you must restart the debugger.

Note The GUI mode does not provide a graphical version of the `run` command. To run the simulation to the end, you must first clear all breakpoints and then click the Start/Continue button.

Debug Pointer

Whenever the debugger stops the simulation at a method, it displays a debug pointer on the block diagram of the model being debugged.

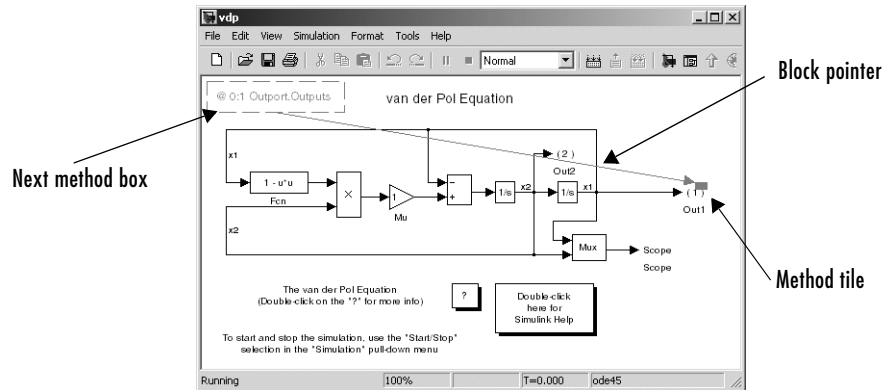

The debug pointer is an annotation that indicates the next method to be executed when simulation resumes. It consists of the following elements:

- Next method box
- Block pointer
- Method tile

Next Method Box

The next method box appears in the upper left corner of the block diagram. It specifies the name and ID of the next method to be executed.

Block Pointer

The block pointer appears when the next method is a block method. It indicates the block on which the next method operates.

Method Tile

The method tile is a rectangular patch of color that appears when the next method is a block method. The tile overlays a portion of the block on which the

next method executes. The color and position of the tile on the block indicate the type of the next block method as follows.

Update (red)	Outputs Major Time Step (dark green)
Derivatives (orange)	Outputs Minor Time Step (green)
Zero Crossings (light blue)	Start (magenta) Initialize (blue) etc.

In animation mode, the tiles persist for the length of the current major time step and a number appears in each tile. The number specifies the number of times that the corresponding method has been invoked for the block thus far in the time step.

Setting Breakpoints

The Simulink debugger allows you to define stopping points in a simulation called breakpoints. You can then run a simulation from breakpoint to breakpoint, using the debugger's `continue` command. The debugger lets you define two types of breakpoints: unconditional and conditional. An unconditional breakpoint occurs whenever a simulation reaches a method that you specified previously. A conditional breakpoint occurs when a condition that you specified in advance arises in the simulation.

Breakpoints are useful when you know that a problem occurs at a certain point in your program or when a certain condition occurs. By defining an appropriate breakpoint and running the simulation via the `continue` command, you can skip immediately to the point in the simulation where the problem occurs.

Setting Unconditional Breakpoints

You can set unconditional breakpoints from the

- Debugger toolbar
- **Simulation Loop** pane
- MATLAB Command Window (command-line mode only)

Setting Breakpoints from the Debugger Toolbar

To set a breakpoint on a block's methods, select the block and then click the Breakpoint button on the debugger toolbar.

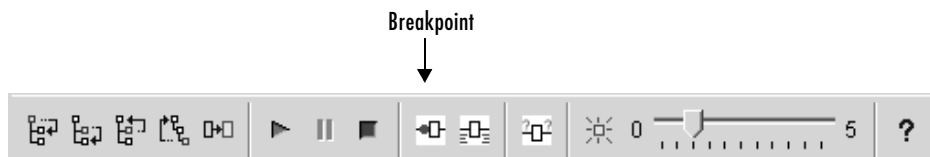

The debugger displays the name of the selected block in the **Break/Display points** panel of its **Breakpoints** pane.

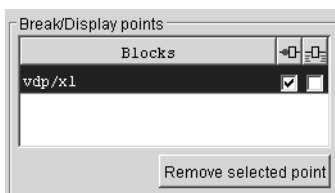

Note Clicking the Breakpoint button on the toolbar sets breakpoints on the invocations of a block's methods in major time steps. To enable breakpoints in minor time steps, you must select the debugger's **Minor time steps** option (see "Breaking in Minor Time Steps" on page 13-27).

You can temporarily disable the breakpoints on a block by deselecting the check box in the breakpoints column of the panel. To clear the breakpoints on a block and remove its entry from the panel, select the entry and then click the **Remove selected point** button on the panel.

Note You cannot set a breakpoint on a virtual block. A virtual block is a block whose function is purely graphical: it indicates a grouping or relationship among a model's computational blocks. The debugger warns you if you attempt to set a breakpoint on a virtual block. You can obtain a listing of a model's nonvirtual blocks, using the `slist` command (see "Displaying a Model's Nonvirtual Blocks" on page 13-33).

Setting Breakpoints from the Simulation Loop Pane

To set a breakpoint at a particular invocation of a method displayed in the Simulation Loop pane, select the check box next to the method's name in the breakpoint column of the pane.

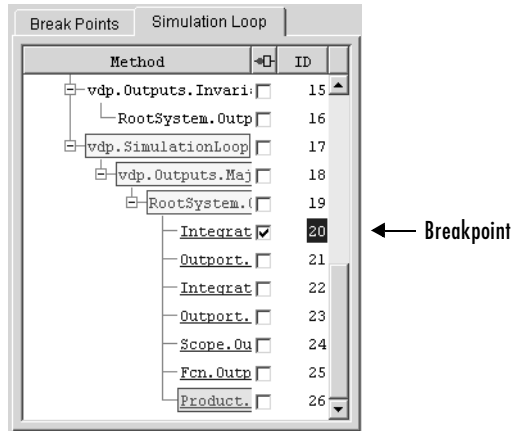

To clear the breakpoint, deselect the check box.

Setting Breakpoints from the MATLAB Command Window

In command-line mode, use the `break` and `bafter` commands to set breakpoints before or after a specified method, respectively. Use the `clear` command to clear breakpoints.

Setting Conditional Breakpoints

You can use either the **Break on conditions** panel of the debugger's **Breakpoints** pane

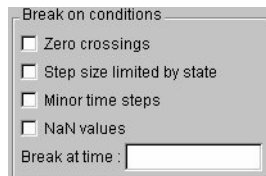

or the following commands (in command-line mode) to set conditional breakpoints.

Command	Causes Simulation to Stop
<code>tbreak [τ]</code>	At a simulation time step
<code>minor</code>	At methods invoked in minor time steps
<code>nanbreak</code>	At the occurrence of an underflow or overflow (NaN) or infinite (Inf) value
<code>xbreak</code>	When the simulation reaches the state that determines the simulation step size
<code>zcbreak</code>	When a zero crossing occurs between simulation time steps

Setting Breakpoints at Time Steps

To set a breakpoint at a time step, enter a time in the debugger's **Break at time** field (GUI mode) or enter the time using the `tbreak` command. This causes the debugger to stop the simulation at the `Outputs.Major` method of the model at the first time step that follows the specified time. For example, starting `vdp` in debug mode and entering the commands

```
tbreak 2
continue
```

causes the debugger to halt the simulation at the `vdp.Outputs.Major` method of time step 2.078 as indicated by the output of the `continue` command.

```
%-----%
[TM = 2.078784598291364      ] vdp.Outputs.Major
(s1debug @18):
```

Breaking on Nonfinite Values

Selecting the debugger's **NaN values** option or entering the `nanbreak` command causes the simulation to stop when a computed value is infinite or outside the range of values that can be represented by the machine running the

simulation. This option is useful for pinpointing computational errors in a Simulink model.

Breaking on Step-Size Limiting Steps

Selecting the **Step size limited by state** option or entering the `xbreak` command causes the debugger to stop the simulation when the model uses a variable-step solver and the solver encounters a state that limits the size of the steps that it can take. This command is useful in debugging models that appear to require an excessive number of simulation time steps to solve.

Breaking at Zero Crossings

Selecting the **Zero crossings** option or entering the `zcbreak` command causes the simulation to halt when Simulink detects a nonsampled zero crossing in a model that includes blocks where zero crossings can arise. After halting, Simulink displays the location in the model, the time, and the type (rising or falling) of the zero crossing. For example, setting a zero-crossing break at the start of execution of the `zeroxing` demo model,

```
sldebug zeroxing
%-----%
[TM = 0                               ] zeroxing.Simulate
(sldebug @0): zcbreak
Break at zero crossing events          : enabled
```

and continuing the simulation

```
(sldebug @0): continue
```

results in a rising zero-crossing break at

```
[Tz = 0.2                               ] [Hz = 0                               ]
Detected 2 Zero Crossing Events 0:5:1R, 0:5:2R
%-----%
[tm = 0.4                               ] zeroxing.ZeroCrossingDetectionLoop
(sldebug @45):
```

If a model does not include blocks capable of producing nonsampled zero crossings, the command prints a message advising you of this fact.

Breaking in Minor Time Steps

To break at invocations of a block's methods in minor time steps, select the **Minor time steps** option on the debugger's **Break on conditions** panel or enter `minor` at the debugger command prompt.

Note For this option to take effect, you must previously or subsequently set breakpoints on all the block's methods, using either the Breakpoint button on the debugger's toolbar or the `break gcb` or `bafter gcb` command. This option has no effect on breakpoints set on specific invocations of a block's methods set in either the **Simulation Loop** pane or via the `break/bafter m:id` commands.

Displaying Information About the Simulation

The Simulink debugger provides a set of commands that allow you to display block states, block inputs and outputs, and other information while running a model.

Displaying Block I/O

The debugger allows you to display block I/O by clicking the appropriate buttons on the debugger toolbar

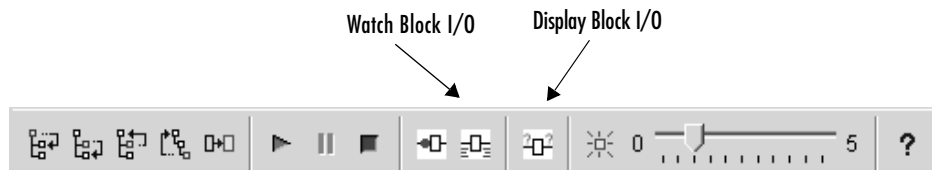

or by entering the appropriate debugger command.

Command	Displays a Block's I/O
probe	Immediately
disp	At every breakpoint
trace	Whenever the block executes

Displaying I/O of Selected Block

To display the I/O of a block, select the block and click  in GUI mode or enter the probe command in command-line mode.

Command	Description
probe	Enter or exit probe mode. In probe mode, the debugger displays the current inputs and outputs of any block that you select in the model's block diagram. Typing any command causes the debugger to exit probe mode.
probe gcb	Display I/O of selected block.
probe s:b	Print the I/O of the block specified by system number s and block number b.

The debugger prints the current inputs, outputs, and states of the selected block in the debugger **Outputs** pane (GUI mode) or the MATLAB Command Window.

The probe command is useful when you need to examine the I/O of a block whose I/O is not otherwise displayed. For example, suppose you are using the step command to run a model method by method. Each time you step the simulation, the debugger displays the inputs and outputs of the current block. The probe command lets you examine the I/O of other blocks as well.



Displaying Block I/O Automatically at Breakpoints

The disp command causes the debugger to display a specified block's inputs and outputs whenever it halts the simulation. You can specify a block either by entering its block index or by selecting it in the block diagram and entering gcb as the disp command argument. You can remove any block from the debugger's list of display points, using the undisp command. For example, to remove block 0:0, either select the block in the model diagram and enter undisp gcb or simply enter undisp 0:0.

Note Automatic display of block I/O at breakpoints is not available in the debugger's GUI mode.

The `disp` command is useful when you need to monitor the I/O of a specific block or set of blocks as you step through a simulation. Using the `disp` command, you can specify the blocks you want to monitor and the debugger will then redisplay the I/O of those blocks on every step. Note that the debugger always displays the I/O of the current block when you step through a model block by block, using the `step` command. You do not need to use the `disp` command if you are interested in watching only the I/O of the current block.

Watching Block I/O

To watch a block, select the block and click  in the debugger toolbar or enter the `trace` command. In GUI mode, if a breakpoint exists on the block, you can set a watch on it as well by selecting the check box for the block in the watch column  of the **Break/Display points** pane. In command-line mode, you can also specify the block by specifying its block index in the `trace` command. You can remove a block from the debugger's list of trace points using the `untrace` command.

The debugger displays a watched block's I/O whenever the block executes. Watching a block allows you obtain a complete record of the block's I/O without having to stop the simulation.

Displaying Algebraic Loop Information

The `atrace` command causes the debugger to display information about a model's algebraic loops (see "Algebraic Loops" on page 2-23) each time they are solved. The command takes a single argument that specifies the amount of information to display.

Command	Displays for Each Algebraic Loop
<code>atrace 0</code>	No information
<code>atrace 1</code>	The loop variable solution, the number of iterations required to solve the loop, and the estimated solution error
<code>atrace 2</code>	Same as level 1
<code>atrace 3</code>	Level 2 plus the Jacobian matrix used to solve the loop
<code>atrace 4</code>	Level 3 plus intermediate solutions of the loop variable

Displaying System States

The `sldebug` command lists the current values of the system's states in the MATLAB Command Window. For example, the following sequence of commands shows the states of the Simulink bouncing ball demo (`bounce`) after its first and second time steps.

```
sldebug bounce
[Tm=0                ] **Start** of system 'bounce' outputs
(sldebug @0:0 'bounce/Position'): states
Continuous state vector (value,index,name):
    10                0 (0:0 'bounce/Position')
    15                1 (0:5 'bounce/Velocity')
(sldebug @0:0 'bounce/Position'): next
[Tm=0.01            ] **Start** of system 'bounce' outputs
(sldebug @0:0 'bounce/Position'): states
Continuous state vector (value,index,name):
    10.1495095       0 (0:0 'bounce/Position')
    14.9019          1 (0:5 'bounce/Velocity')
```

Displaying Integration Information

The `ishow` command toggles display of integration information. When enabled, this option causes the debugger to display a message each time the simulation takes a time step or encounters a state that limits the size of a time step. In the first case, the debugger displays the size of the time step, for example,

```
[Tm=9.996264188473381 ] Step of 0.01 was taken by integrator
```

In the second case, the debugger displays the state that currently determines the size of time steps, for example,

```
[Ts=9.676264188473388 ] Integration limited by 1st state of
block 0:0 'bounce/Position'
```

Displaying Information About the Model

In addition to providing information about a simulation, the debugger can provide you with information about the model that underlies the simulation.

Displaying a Model's Sorted Lists

In GUI mode, the debugger's **Sorted List** pane displays lists of blocks for a model's root system and each nonvirtual subsystem. Each list lists the blocks that the subsystems contains sorted according to their computational dependencies, alphabetical order, and other block sorting rules. In command-line mode, you can use the `slist` command to display a model's sorted lists.

```
--- Sorted list for 'vdp' [12 blocks, 9 nonvirtual blocks,
directFeed=0]
0:0   'vdp/Integrator1' (Integrator)
0:1   'vdp/Out1' (Outputport)
0:2   'vdp/Integrator2' (Integrator)
0:3   'vdp/Out2' (Outputport)
0:4   'vdp/Fcn' (Fcn)
0:5   'vdp/Product' (Product)
0:6   'vdp/Mu' (Gain)
0:7   'vdp/Scope' (Scope)
0:8   'vdp/Sum' (Sum)
```

These displays include the block index for each command. You can thus use them to determine the block IDs of the model's blocks. Some debugger commands accept block IDs as arguments.

Identifying Blocks in Algebraic Loops

If a block belongs to an algebraic list, the `slist` command displays an algebraic loop identifier in the entry for the block in the sorted list. The identifier has the form

```
algId=s#n
```

where `s` is the index of the subsystem containing the algebraic loop and `n` is the index of the algebraic loop in the subsystem. For example, the following entry

for an Integrator block indicates that it participates in the first algebraic loop at the root level of the model.

```
0:1 'test/ss/I1' (Integrator, tid=0) [algId=0#1, discontinuity]
```

You can use the debugger's `ashow` command to highlight the blocks and lines that make up an algebraic loop. See “Displaying Algebraic Loops” on page 13-35 for more information.

Displaying a Block

To determine the block in a model's diagram that corresponds to a particular index, enter `bshow s:b` at the command prompt, where `s:b` is the block index. The `bshow` command opens the system containing the block (if necessary) and selects the block in the system's window.

Displaying a Model's Nonvirtual Systems

The `systems` command displays a list of the nonvirtual systems in the model being debugged. For example, the Simulink clutch demo (`clutch`) contains the following systems:

```
sdebug clutch
[Tm=0 ] **Start** of system 'clutch' outputs
(sdebug @0:0 'clutch/Clutch Pedal'): systems
0 'clutch'
1 'clutch/Locked'
2 'clutch/Unlocked'
```

Note The `systems` command does not list subsystems that are purely graphical in nature, that is, subsystems that the model diagram represents as Subsystem blocks but that Simulink solves as part of a parent system. In Simulink models, the root system and triggered or enabled subsystems are true systems. All other subsystems are virtual (that is, graphical) and hence do not appear in the listing produced by the `systems` command.

Displaying a Model's Nonvirtual Blocks

The `slist` command displays a list of the nonvirtual blocks in a model. The listing groups the blocks by system. For example, the following sequence of

commands produces a list of the nonvirtual blocks in the Van der Pol (vdp) demo model.

```
sdebug vdp
[Tm=0                ] **Start** of system 'vdp' outputs
(sdebug @0:0 'vdp/Integrator1'): slist
---- Sorted list for 'vdp' [12 blocks, 9 nonvirtual blocks,
directFeed=0]
 0:0  'vdp/Integrator1' (Integrator)
 0:1  'vdp/Out1' (Outputport)
 0:2  'vdp/Integrator2' (Integrator)
 0:3  'vdp/Out2' (Outputport)
 0:4  'vdp/Fcn' (Fcn)
 0:5  'vdp/Product' (Product)
 0:6  'vdp/Mu' (Gain)
 0:7  'vdp/Scope' (Scope)
 0:8  'vdp/Sum' (Sum)
```

Note The `slist` command does not list blocks that are purely graphical in nature, that is, blocks that indicate relationships or groupings among computational blocks.

Displaying Blocks with Potential Zero Crossings

The `zclist` command displays a list of blocks in which nonsampled zero crossings can occur during a simulation. For example, `zclist` displays the following list for the clutch sample model:

```
(sdebug @0:0 'clutch/Clutch Pedal'): zclist
 2:3  'clutch/Unlocked/Sign' (Signum)
 0:4  'clutch/Lockup Detection/Velocities Match' (HitCross)
 0:10 'clutch/Lockup Detection/Required Friction
      for Lockup/Abs' (Abs)
 0:11 'clutch/Lockup Detection/Required Friction for
      Lockup/ Relational Operator' (RelationalOperator)
 0:18 'clutch/Break Apart Detection/Abs' (Abs)
 0:20 'clutch/Break Apart Detection/Relational Operator'
      (RelationalOperator)
```



```
0:24 'clutch/Unlocked' (SubSystem)
0:27 'clutch/Locked' (SubSystem)
```

Displaying Algebraic Loops

The `ashow` command highlights a specified algebraic loop or the algebraic loop that contains a specified block. To highlight a specified algebraic loop, enter `ashow s#n`, where `s` is the index of the system (see “Identifying Blocks in Algebraic Loops” on page 13-32) that contains the loop and `n` is the index of the loop in the system. To display the loop that contains the currently selected block, enter `ashow gcb`. To show a loop that contains a specified block, enter `ashow s:b`, where `s:b` is the block’s index. To clear algebraic-loop highlighting from the model diagram, enter `ashow clear`.

Displaying Debugger Status

In GUI mode, the debugger displays the settings of various debug options, such as conditional breakpoints, in its **Status** panel. In command-line mode, the `status` command displays debugger settings. For example, the following sequence of commands displays the initial debug settings for the `vdp` model:

```
sim('vdp',[0,10],simset('debug','on'))
[Tm=0          ] **Start** of system 'vdp' outputs
(sldbug @0:0 'vdp/Integrator1'): status
Current simulation time: 0 (MajorTimeStep)
Last command: ""
Stop in minor times steps is disabled.
Break at zero crossing events is disabled.
Break when step size is limiting by a state is disabled.
Break on non-finite (NaN,Inf) values is disabled.
Display of integration information is disabled.
Algebraic loop tracing level is at 0.
```

Simulink Accelerator

The Simulink Accelerator is a MathWorks product that accelerates the simulation of Simulink models. The Simulink Accelerator comes with the Simulink Profiler, a tool that collects, analyzes, and displays simulation performance data. These tools enable you to minimize the time needed to simulate Simulink models. You must install the Simulink Accelerator product on your system to use either tool. See the following sections for information on using these tools.

The Simulink Accelerator (p. 14-2)

How to use the Simulink Accelerator to speed up a simulation.

Profiler (p. 14-12)

How to use the Simulink Profiler to tune the performance of your model.

The Simulink Accelerator

The Simulink Accelerator speeds up the execution of Simulink models. The Accelerator uses portions of Real-Time Workshop, a MathWorks product that automatically generates C code from Simulink models, and your C compiler to create an executable. Note that although the Simulink Accelerator takes advantage of the Real-Time Workshop technology, Real-Time Workshop is not required to run it. Also, if you do not have a C compiler installed on your Windows PC, you can use the `lcc` compiler provided by The MathWorks.

Note You must have the Simulink Accelerator product installed on your system to use the accelerator.

Accelerator Limitations

The Simulink Accelerator has the following limitations.

- The Accelerator does not support models with algebraic loops. If the accelerator detects an algebraic loop in your model, it halts the simulation and displays an error message.
- The Accelerator does not support models that pass array parameters to M-File S-Functions that are not numeric, logical, or character arrays, are sparse arrays, or that have more than two dimensions.

How the Accelerator Works

The Simulink Accelerator works by creating and compiling C code that takes the place of the interpretive code that Simulink uses when in Normal mode (that is, when Simulink is not in Accelerator mode). The Accelerator generates the C code from your Simulink model, and the MATLAB `mex` function invokes your compiler and dynamically links the generated code to Simulink.

The Simulink Accelerator removes much of the computational overhead required by Simulink models when in Normal mode. It works by replacing blocks that are designed to handle any possible configuration in Simulink with compiled versions customized to your particular model's configuration. Through this method, the Accelerator is able to achieve substantial improvements in performance for larger Simulink models. The performance

gains are tied to the size and complexity of your model. In general, as size and complexity grow, so do gains in performance. Typically, you can expect a 2X-to-6X gain in performance for models that use built-in Simulink blocks.

Note Blocks such as the Quantizer block might exhibit slight differences in output on some systems because of slight differences in the numerical precision of the interpreted and compiled versions of the model.

Running the Simulink Accelerator

To activate the Simulink Accelerator, select **Accelerator** from the **Simulation** menu for your model. This picture shows the procedure using the F14 flight control model.

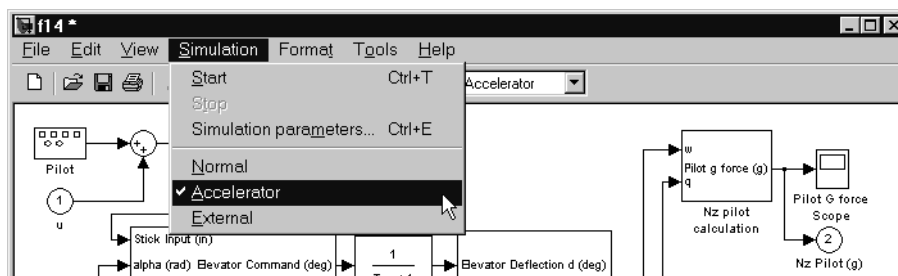

Alternatively, you can select **Accelerator** from the menu located on the right-hand side of the toolbar.

To begin the simulation, select **Start** from the **Simulation** menu. When you start the simulation, the Accelerator generates the C code and compiles it. The Accelerator then does the following:

- Places the generated code in a subdirectory called `modelName_accel_rtw` (in this case, `f14_accel_rtw`)
- Places a compiled MEX-file in the current working directory
- Runs the compiled model

Note If your code does not compile, the most likely reason is that you have not set up the `mex` command correctly. Run `mex -setup` at the MATLAB prompt and select your C compiler from the list shown during the setup.

The Accelerator uses the Real-Time Workshop technology to generate the code used to accelerate the model. However, the generated code is suitable only for acceleration of the model. If you want to generate code for other purposes, you must use Real-Time Workshop.

Handling Changes in Model Structure

After you use the Simulink Accelerator to simulate a model, the MEX-file containing the compiled version of the model remains available for use in later simulations. Even if you exit MATLAB, you can reuse the MEX-file in later MATLAB or Simulink sessions.

If you alter the structure of your Simulink model, for example, by adding or deleting blocks, the Accelerator automatically regenerates the C code and updates (overwrites) the existing MEX-file.

Examples of model structure changes that require the Accelerator to rebuild include

- Changing the method of integration
- Adding or deleting blocks or connections between blocks
- Changing the values of nontunable block parameters, for example, the **Initial seed** parameter of the Random Number block (see “Tunable Parameters” on page 2-8 for more information)
- Changing the number of inputs or outputs of blocks, even if the connectivity is vectorized
- Changing the number of states in the model
- Changing function in the Trigonometric Function block
- Changing the signs used in a Sum block
- Adding a Target Language Compiler (TLC) file to inline an S-function

The Simulink Accelerator displays a warning when you attempt any impermissible model changes during simulation. The warning does not stop

the current simulation. To make the model alterations, stop the simulation, make the changes, and restart.

Some changes are permitted in the middle of simulation. Simple changes like adjusting the value of a Gain block do not cause a warning. When in doubt, try to make the change. If you do not see a warning, the Accelerator accepted the change.

Note that the Accelerator does not display warnings that blocks generate *during* simulation. Examples include divide-by-zero and integer overflow. This is a different set of warnings from those discussed previously.

Increasing Performance of Accelerator Mode

In general, the Simulink Accelerator creates code optimized for speed with most blocks available in Simulink. There are situations, however, where you can further improve performance by adjusting your simulation or being aware of Accelerator behavior. These include

- **Configuration Parameters** dialog box — To increase performance:
 - Disable **Solver data inconsistency** and **Array bounds exceeded** on the **Diagnostics** pane.
 - Set **Signal storage reuse** on in the **Optimization** pane.
- **Stateflow** — The Accelerator is fully compatible with Stateflow, but it does not improve the performance of the Stateflow portions of models. Disable Stateflow debugging and animation to increase performance of models that include Stateflow blocks.
- **User-written S-functions** — The Accelerator cannot improve simulation speed for S-functions unless you inline them using the Target Language Compiler. *Inlining* refers to the process of creating TLC files that direct Real-Time Workshop to create C code for the S-function. This eliminates unnecessary calls to the Simulink application program interface (API).
For information on how to inline S-functions, consult the *Real-Time Workshop Target Language Compiler Reference Guide*, which is available on the MathWorks Web site, www.mathworks.com.
- **S-functions supplied by Simulink and blocksets** — Although the Simulink Accelerator is compatible with all the blocks provided with Simulink and blocksets, it does not improve the simulation speed for M-file or C-MEX S-Function blocks that do not have an associated inlining TLC file.

- Logging large amounts of data — If you use Workspace I/O, To Workspace, To File, or Scope blocks, large amounts of data will slow the Accelerator down. Try using decimation or limiting outputs to the last N data points.
- Large models — In both Accelerator and Normal mode, Simulink can take significant time to initialize large models. Accelerator speedup can be minimal if run-times (from start to finish of a single simulation) are small.

Blocks That Do Not Show Speed Improvements

The Simulink Accelerator speeds up execution only of blocks from Simulink and the Signal Processing Blockset. Further, the Accelerator does not improve the performance of some blocks in Simulink and the Signal Processing Blockset. The following sections list these blocks.

Simulink Blocks

- Display
- From File
- From Workspace
- Inport (root level only)
- MATLAB Fcn
- Outport (root level only)
- Scope
- To File
- To Workspace
- Transport Delay
- Variable Transport Delay
- XY Graph

Signal Processing Blockset Blocks

- Biquadratic Filter
- Convolution
- Direct-Form II Transpose Filter
- Dyadic Analysis Filter Bank

- Dyadic Synthesis Filter Bank
- FIR Decimation
- FIR Interpolation
- FIR Rate Conversion
- From Wave Device
- From Wave File
- Integer Delay
- Variable Integer Delay
- Matrix Multiply
- Matrix To Workspace
- Triggered Signal To Workspace
- Triggered Signal From Workspace
- Time-Varying Direct-Form II Transpose Filter
- To Wave File
- To Wave Device
- Wavelet Analysis
- Wavelet Synthesis
- Zero Pad

User-Written S-Function Blocks

In addition, the Accelerator does not speed up user-written S-Function blocks unless you inline them using the Target Language Compiler and set `SS_OPTION_USE_TLC_WITH_ACCELERATOR` in the S-function itself. See “Controlling S-Function Execution” on page 14-11 for more information.

Using the Simulink Accelerator with the Simulink Debugger

If you have large and complex models that you need to debug, the Simulink Accelerator can shorten the length of your debugging sessions. For example, if you need to set a time break that is very large, you can use the Accelerator to reach the breakpoint more quickly.

To run the Simulink debugger while in Accelerator mode:

- 1 Select **Accelerator** from the **Simulation** menu, then enter
`sldebug modelName`
at the MATLAB prompt.
- 2 At the debugger prompt, set a time break:
`tbreak 10000`
`continue`
- 3 Once you reach the breakpoint, use the debugger command `emode` (execution mode) to toggle between Accelerator and Normal mode.

Note that you must switch to Normal mode to step the simulation by blocks. You must also switch to Normal mode to use the following debug commands:

- `trace`
- `break`
- `zcbreak`
- `nanbreak`
- `minor`

For more information on the Simulink debugger, see Chapter 13, “Simulink Debugger.”

Interacting with the Simulink Accelerator Programmatically

Using three commands, `set_param`, `sim`, and `accelbuild`, you can control the execution of your model from the MATLAB prompt or from M-files. This section describes the syntax for these commands and the options available.

Controlling the Simulation Mode

You can control the simulation mode from the MATLAB prompt using

```
set_param(gcs, 'simulationmode', 'mode')
```

or

```
set_param(modelName, 'simulationmode', 'mode')
```

You can use `gcs` (“get current system”) to set parameters for the currently active model (i.e., the active model window) and `modelName` if you want to specify the model name explicitly. The simulation mode can be either `normal` or `accelerator`.

Simulating an Accelerated Model

You can also simulate an accelerated model using

```
sim(gcs); % Blocks the MATLAB prompt until simulation complete
```

or

```
set_param(gcs, 'simulationcommand', 'start'); % Returns to the
                                                % MATLAB prompt
                                                % immediately
```

Again, you can substitute the `modelName` for `gcs` if you prefer to specify the model explicitly.

Building Simulink Accelerator MEX-Files Independent of Simulation

You can build the Simulink Accelerator MEX-file without actually simulating the model by using the `accelbuild` command, for example,

```
accelbuild f14
```

Creating the Accelerator MEX-files in batch mode using `accelbuild` allows you to build the C code and executables prior to running your simulations. When you use the Accelerator interactively at a later time, it does not need to generate or compile MEX-files at the start of the accelerated simulations.

You can use the `accelbuild` command to specify build options such as turning on debugging symbols in the generated MEX-file.

```
accelbuild f14 OPT_OPTS=-g
```

Comparing Performance

If you want to compare the performance of the Simulink Accelerator to Simulink in Normal mode, use `tic`, `toc`, and the `sim` command. To run the F14 example, use this code (make sure you’re in Normal mode).

```
tic, [t,x,y]=sim('f14',1000);toc
```

```
elapsed_time =
```

```
14.1080
```

In Accelerator mode, this is the result.

```
elapsed_time =
```

```
6.5880
```

These results were achieved on a Windows PC with a 233 MHz Pentium processor.

Note that for models with very short run times, the Normal mode simulation might be faster, because the Accelerator checks at the beginning of any run to see whether it must regenerate the MEX-file. This adds a small overhead to the run-time.

Customizing the Simulink Accelerator Build Process

Typically, no customization is necessary for the Simulink Accelerator build process. However, because the Accelerator uses the same underlying mechanisms as Real-Time Workshop to generate code and build the MEX-file, you can use three parameters to control the build process.

```
AccelMakeCommand  
AccelSystemTargetFile  
AccelTemplateMakeFile
```

The three options allow you to specify custom Make command, System target, and Template makefiles. Each of these parameters governs a portion of the code generation process. Using these options requires an understanding of how Real-Time Workshop generates code. For a description of the Make command, the System target file, and Template makefile, see the *Real-Time Workshop User's Guide*, which is available on the MathWorks Web site, www.mathworks.com.

The syntax for setting these parameters is

```
set_param(gcs, 'parameter', 'string')
```

or

```
set_param(modelname, 'parameter', 'string')
```

where `gcs` (“get current system”) is the currently active model and `'parameter'` is one of the three parameters listed above. Replace `'string'` with your string that defines a custom value for that parameter.

Controlling S-Function Execution

Inlining S-functions using the Target Language Compiler increases performance when used with the Simulink Accelerator. By default, however, the Accelerator ignores an inlining TLC file for an S-function, even though the file exists.

One example of why this default was chosen is a device driver S-Function block for an I/O board. The S-function TLC file is typically written to access specific hardware registers of the I/O board. Because the Accelerator is not running on a target system, but rather is a simulation on the host system, it must avoid using the inlined TLC file for the S-function.

Another example is when the TLC file and MEX-file versions of an S-function are not compatible in their use of work vectors, parameters, and/or initialization.

If your inlined S-function is not complicated by these issues, you can direct the Accelerator to use the TLC file instead of the S-function MEX-file by specifying `SS_OPTION_USE_TLC_WITH_ACCELERATOR` in the `mdlInitializeSizes` function of the S-function. When set, the Accelerator uses the inlining TLC file and full performance increases are realized. For example:

```
static void mdlInitializeSizes(SimStruct *S)
{
    /* Code deleted */
    ssSetOptions(S, SS_OPTION_USE_TLC_WITH_ACCELERATOR);
}
```

Profiler

The Simulink simulation profiler collects performance data while simulating your model and generates a report, called a *simulation profile*, based on the data. The simulation profile generated by the profiler shows you how much time Simulink spends executing each function required to simulate your model. The profile enables you to determine the parts of your model that require the most time to simulate and hence where to focus your model optimization efforts.

Note You must have the Simulink Accelerator product installed on your system to use the profiler.

How the Profiler Works

The following pseudocode summarizes the execution model on which the profiler is based.

```
Sim()
  ModelInitialize().
  ModelExecute()
    for t = tStart to tEnd
      Output()
      Update()
      Integrate()
        Compute states from derivs by repeatedly calling:
          MinorOutput()
          MinorDeriv()
        Locate any zero crossings by repeatedly calling:
          MinorOutput()
          MinorZeroCrossings()
      EndIntegrate
    Set time t = tNew.
  EndModelExecute
  ModelTerminate
EndSim
```

According to this conceptual model, Simulink executes a Simulink model by invoking the following functions zero, one, or more times, depending on the function and the model.

Function	Purpose	Level
sim	Simulate the model. This top-level function invokes the other functions required to simulate the model. The time spent in this function is the total time required to simulate the model.	System
ModelInitialize	Set up the model for simulation.	System
ModelExecute	Execute the model by invoking the output, update, integrate, etc., functions for each block at each time step from the start to the end of simulation.	System
Output	Compute the outputs of a block at the current time step.	Block
Update	Update a block's state at the current time step.	Block
Integrate	Compute a block's continuous states by integrating the state derivatives at the current time step.	Block
MinorOutput	Compute a block's output at a minor time step.	Block
MinorDeriv	Compute a block's state derivatives at a minor time step.	Block
MinorZeroCrossings	Compute a block's zero-crossing values at a minor time step.	Block

Function	Purpose	Level
ModelTerminate	Free memory and perform any other end-of-simulation cleanup.	System
Nonvirtual Subsystem	Compute the output of a nonvirtual subsystem (see “Solvers” on page 2-17) at the current time step by invoking the output, update, integrate, etc., functions for each block that it contains. The time spent in this function is the time required to execute the nonvirtual subsystem.	Block

The profiler measures the time required to execute each invocation of these functions and generates a report at the end of the model that describes how much time was spent in each function.

Enabling the Profiler

To profile a model, open the model and select **Profiler** from the Simulink **Tools** menu. Then start the simulation. When the simulation finishes, Simulink generates and displays the simulation profile for the model in the MATLAB Help browser.

The Simulation Profile

Simulink stores the simulation profile in the MATLAB working directory.

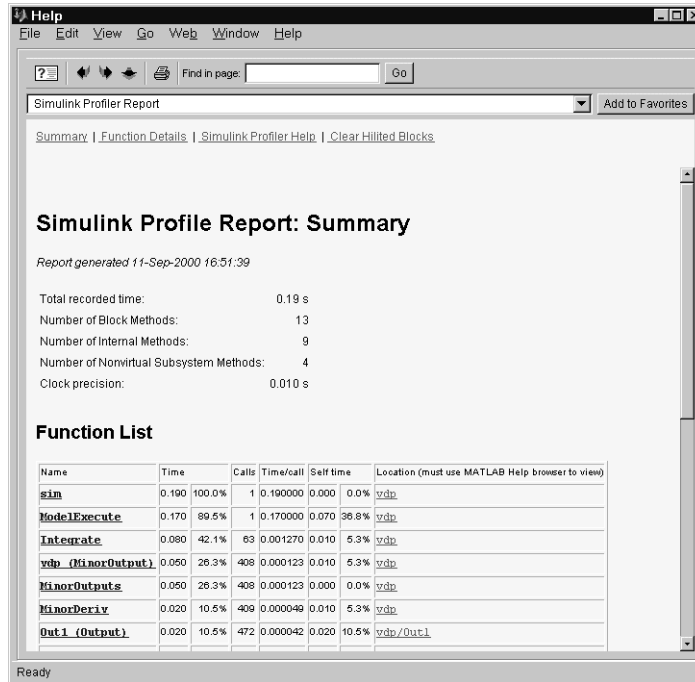

The report has two sections: a summary and a detailed report.

Summary Section

The summary file displays the following performance totals.

Item	Description
Total Recorded Time	Total time required to simulate the model
Number of Block Methods	Total number of invocations of block-level functions (e.g., Output ())

Item	Description
Number of Internal Methods	Total number of invocations of system-level functions (e.g., ModelExecute)
Number of Nonvirtual Subsystem Methods	Total number of invocations of nonvirtual subsystem functions
Clock Precision	Precision of the profiler's time measurement

The summary section then shows summary profiles for each function invoked to simulate the model. For each function listed, the summary profile specifies the following information.

Item	Description
Name	Name of function. This item is a hyperlink. Clicking it displays a detailed profile of this function.
Time	Total time spent executing all invocations of this function as an absolute value and as a percentage of the total simulation time
Calls	Number of times this function was invoked
Time/Call	Average time required for each invocation of this function, including the time spent in functions invoked by this function
Self Time	Average time required to execute this function, excluding time spent in functions called by this function
Location	Specifies the block or model executed for which this function is invoked. This item is a hyperlink. Clicking it highlights the corresponding icon in the model diagram. Note that the link works only if you are viewing the profile in the MATLAB Help browser.

Detailed Profile Section

This section contains detailed profiles for each function invoked to simulate the model. Each detailed profile contains all the information shown in the summary profile for the function. In addition, the detailed profile displays the function (parent function) that invoked the profiled function and the functions (child functions) invoked by the profiled function. Clicking the name of the parent or a child function takes you to the detailed profile for that function.

Using the Embedded MATLAB Function Block

The Embedded MATLAB Function block lets you use MATLAB code in models intended to be deployed as stand-alone executables generated by Real-Time Workshop. The following sections explain how to use the block to create such models.

Introduction to Embedded MATLAB Function Blocks (p. 15-2)

Overview of the use of Embedded MATLAB Function blocks in Simulink.

Creating an Example Embedded MATLAB Function (p. 15-7)

How to create an example Simulink model with an Embedded MATLAB Function block that you program.

Debugging an Embedded MATLAB Function (p. 15-20)

How to debug the Embedded MATLAB function for the example model you create in the previous section.

The Embedded MATLAB Function Editor (p. 15-30)

Reference of operations available in the **Embedded MATLAB Editor**.

Typing Function Arguments (p. 15-39)

How to specify argument types in the **Model Explorer**.

Sizing Function Arguments (p. 15-45)

How to specify argument sizes in the **Model Explorer**.

Parameter Arguments in Embedded MATLAB Functions (p. 15-50)

How to pass Simulink parameters and MATLAB variables as arguments to an Embedded MATLAB Function block.

Local Variables in Embedded MATLAB Functions (p. 15-52)

Reference of variable types supported by Embedded MATLAB Function blocks.

Functions in Embedded MATLAB Functions (p. 15-56)

Rules for calling functions in the MATLAB workspace and using their return values.

Introduction to Embedded MATLAB Function Blocks

This section introduces the Embedded MATLAB Function block in Simulink. Use the following topics to get an overview of Embedded MATLAB Function blocks, and how and why they are used in Simulink.

- “What Is an Embedded MATLAB Function Block?” on page 15-2
- “Why Use Embedded MATLAB Function Blocks?” on page 15-4

In the next section, “Creating an Example Embedded MATLAB Function” on page 15-7, you build a model with an example Embedded MATLAB Function block.

What Is an Embedded MATLAB Function Block?

The Embedded MATLAB Function block contains a MATLAB function in a Simulink model. The function accepts multiple input signals and produces multiple output signals.

You build the following model in “Creating an Example Embedded MATLAB Function” on page 15-7:

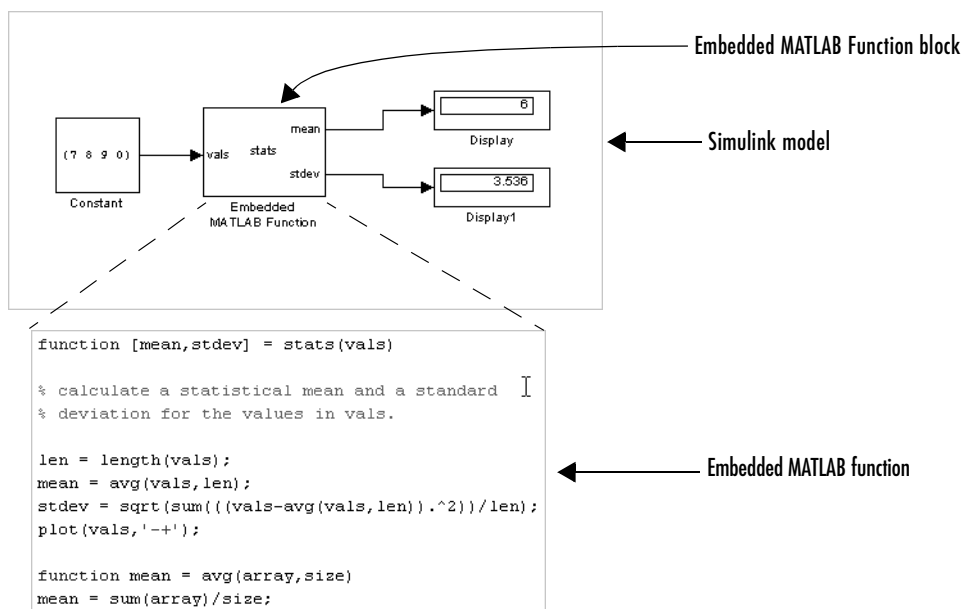

As in a MATLAB function, in the Embedded MATLAB Function block, you can declare a local variable implicitly through assignment. The variable takes its type and size from the context in which it is assigned. For example, the following code line declares `x` to be a scalar variable of type double.

```
x = 1.54;
```

Once you define a variable, it cannot be redefined to any other type or size in the function body. For example, you cannot declare `x` and reassign it as follows:

```
x = 2.65; % OK: x is a scalar double
x = [x 2*x]; % Error: x cannot be changed to a vector
```

See “Declaring Local Variables Implicitly” on page 15-52 for detailed descriptions and examples.

In addition to supporting a rich subset of the MATLAB language, an Embedded MATLAB Function block can call any of the following functions:

- **Subfunctions**

Subfunctions are defined in the body of the Embedded MATLAB block. In the preceding example, `avg` is a subfunction.

- **Embedded MATLAB run-time library functions**

Embedded MATLAB run-time library functions are a subset of the functions that you call in MATLAB. When you build targets for your model, these functions generate C code that conforms to the memory and variable type requirements of embedded environments. In the preceding example, `length`, `sqrt`, and `sum` are Embedded MATLAB run-time library functions.

- **MATLAB functions**

Function calls that cannot be resolved as subfunctions or Embedded MATLAB run-time library functions are resolved in the MATLAB workspace. These functions do not generate code; they execute only in the MATLAB workspace during simulation of the model.

Why Use Embedded MATLAB Function Blocks?

There are many reasons to use Embedded MATLAB Function blocks in your Simulink models. Here are just a few of them:

- **Embedded MATLAB Function blocks can build stand-alone simulation applications** — To support code generation in Real-Time Workshop, the Embedded MATLAB Function block supports a subset of MATLAB commands that generate efficient C code. If you limit the function calls in Embedded MATLAB functions to subfunctions and Embedded MATLAB run-time library functions, you can use Real-Time Workshop to build simulation executables that execute without the MATLAB environment.
- **Embedded MATLAB Function blocks have multiple inputs and outputs** — Unlike MATLABFcn blocks, which take a vector input of values and support a single scalar output, the functions in Embedded MATLAB Function blocks accept multiple inputs and return multiple outputs.
- **Embedded MATLAB Function blocks inherit Simulink input and output signals** — By default, both the size and type of input and output signals to an Embedded MATLAB Function block are inherited from Simulink signals. You can also choose to specify the size and type of inputs and outputs explicitly in the **Model Explorer**.
- **Embedded MATLAB Function blocks have the full power of MATLAB** — Using Embedded MATLAB Function blocks, developers now have access to a wide and growing variety of sophisticated mathematical applications for the embedded environment. You can choose to limit the function calls in Embedded MATLAB Function functions to subfunctions and Embedded MATLAB run-time library functions that generate efficient C code. However, for simulation applications you can call MATLAB functions directly. You can also mix function calls between run-time library functions and MATLAB functions.

- Embedded MATLAB Function blocks can replace Simulink blocks** — Some users might prefer using MATLAB code in place of Simulink block diagrams that are primarily mathematical. Also, certain classes of algorithms are more naturally expressed using a high-level language like MATLAB. For example, the following model contains a subsystem that models the air temperature in an attic space with algebraic blocks:

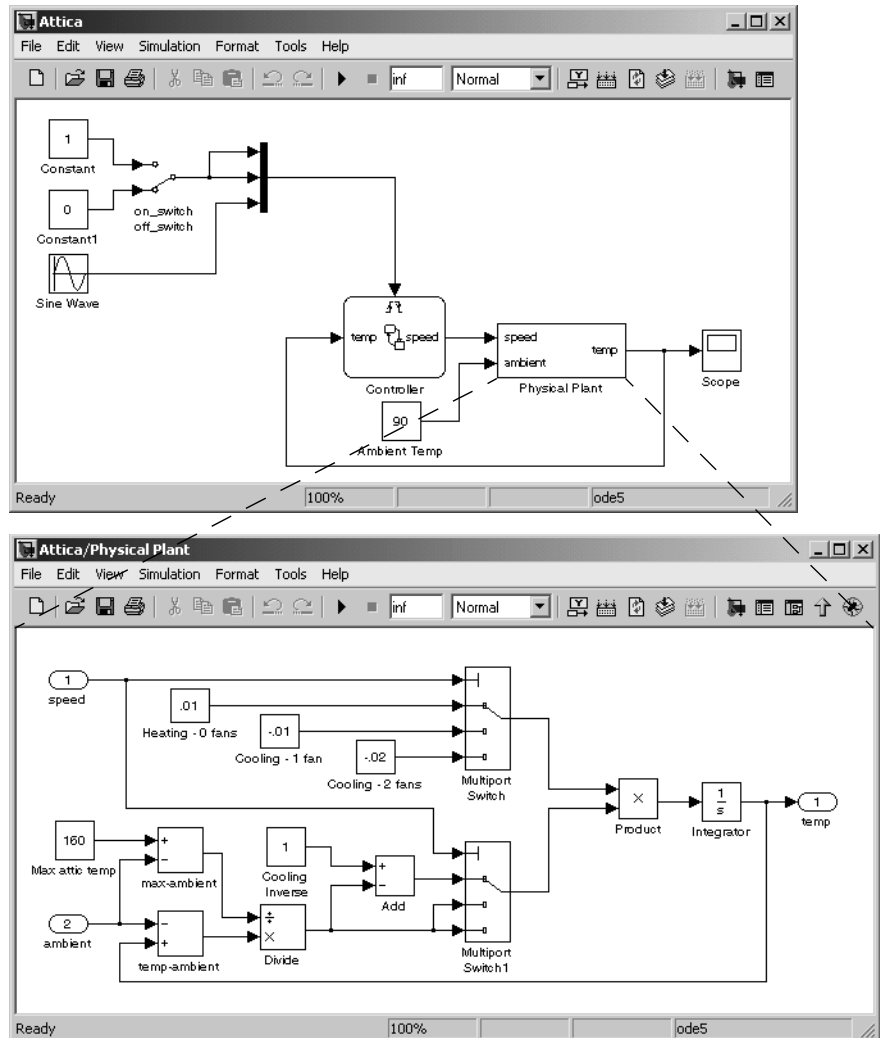

The following model replaces this subsystem with a single Embedded MATLAB Function block:

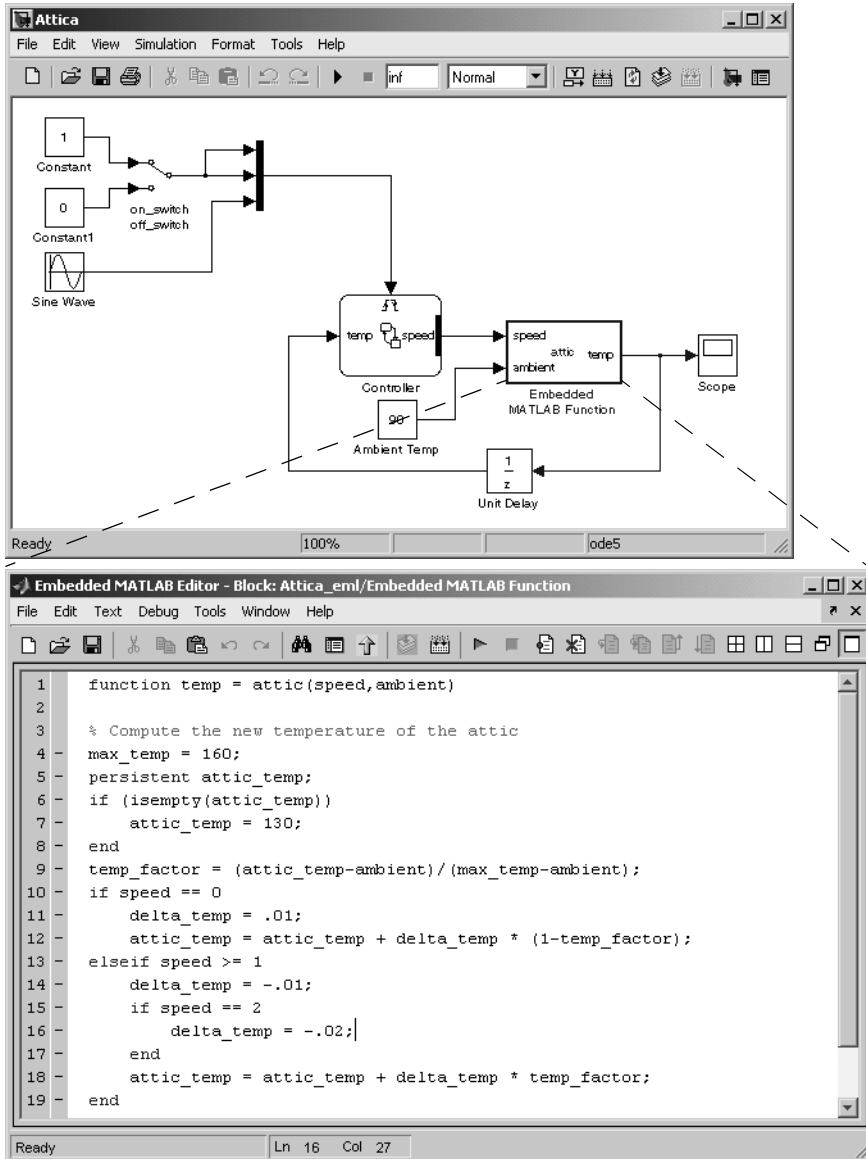

Creating an Example Embedded MATLAB Function

Use the following procedure topics to create a model with an Embedded MATLAB Function block. In the process, learn how to use Embedded MATLAB Function blocks in Simulink.

- 1** “Adding an Embedded MATLAB Function Block to a Model” on page 15-8 — Start by creating a model with an Embedded MATLAB Function block.
- 2** “Programming the Embedded MATLAB Function” on page 15-9 — Use the built-in diagnostics for Embedded MATLAB Function blocks to test for syntax errors in the Embedded MATLAB function body.
- 3** “Checking the Function for Errors” on page 15-15 — Use the built-in diagnostics for Embedded MATLAB Function blocks to test for syntax errors in the Embedded MATLAB function body.
- 4** “Defining Inputs and Outputs” on page 15-17 — Define properties for the input and output arguments of the Embedded MATLAB Function block interface with the **Model Explorer** tool.

Adding an Embedded MATLAB Function Block to a Model

Start by creating an empty Simulink model and filling it with an Embedded MATLAB Function block, and other blocks necessary to complete the model.

- 1 Create a new Simulink model and add an Embedded MATLAB Function block to it from the User-Defined Function library of the Simulink library.

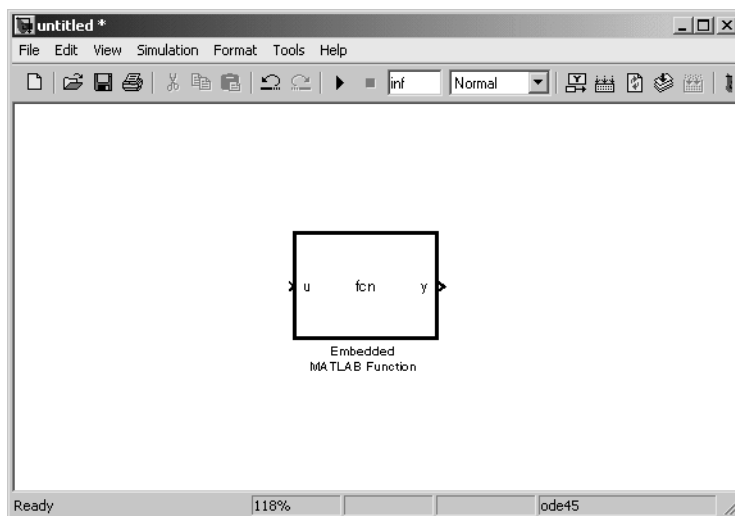

An Embedded MATLAB Function block has two names. The name in the middle of the block is the name of the function you build for the Embedded MATLAB Function block. Its name defaults to `fcn`. The name at the bottom of the block is the name of the block itself. Its name defaults to Embedded MATLAB Function.

The default Embedded MATLAB Function block has an input port and an output port. The input port is associated with the input argument `u`, and the output port is associated with the output argument `y`.

- 2 Add the following Source and Sink blocks to the model:
 - From the Simulink Sources library, add a Constant block to the left of the Embedded MATLAB Function block and set its value to the vector `[2 3 4 5]`.

- From the Simulink Sinks library, add two Display blocks to the right of the Embedded MATLAB Function block.

The model should now have the following appearance:

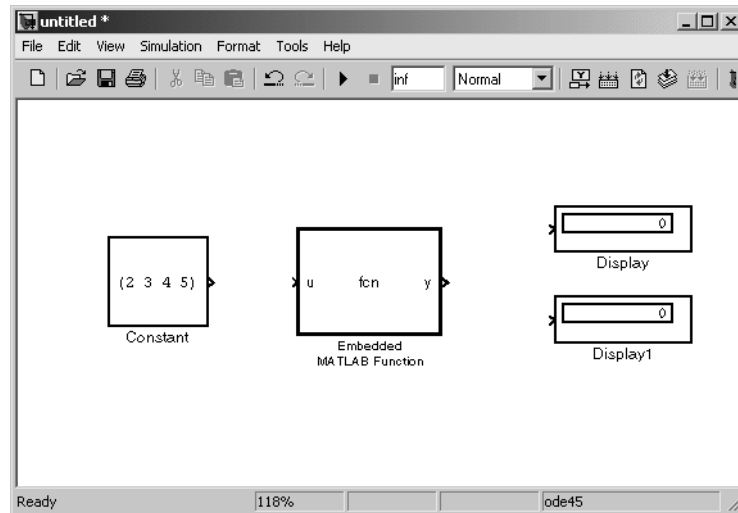

- 3 In the Simulink window, from the **File** menu, select **Save As** and save the model as `call_stats_block1`.

Programming the Embedded MATLAB Function

You create a model with an Embedded MATLAB Function block in “Creating an Example Embedded MATLAB Function” on page 15-7. Now you want to add code to the block to define it as a function that takes a vector set of values and calculates the mean and standard deviation for those values. Use the following steps to program the function stats:

- 1 If not already open, open the `call_stats_block1` model that you save at the end of “Adding an Embedded MATLAB Function Block to a Model” on

page 15-8, and double-click its Embedded MATLAB Function block `fcn` to open it for editing.

The **Embedded MATLAB Editor** appears.

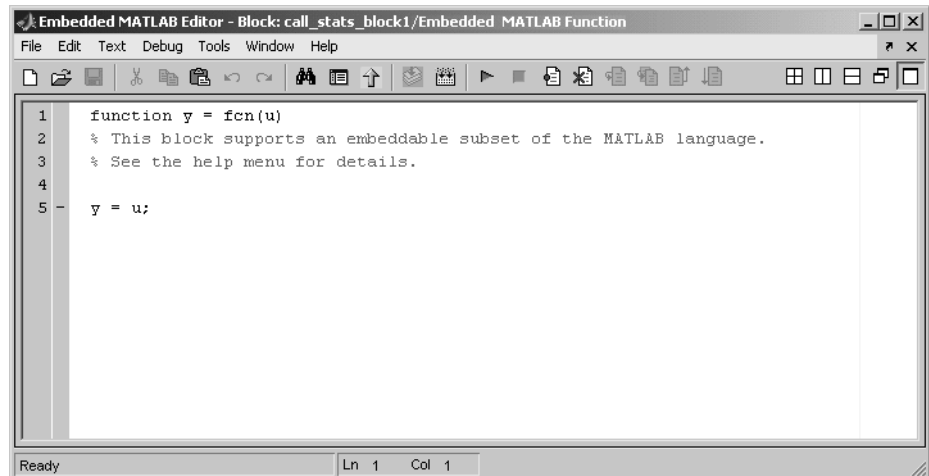

The **Embedded MATLAB Editor** window is titled with the syntax `<model name>/<Embedded MATLAB Function block name>` in its header. In this example, the model name is `call_stats_block1`, and the block name is Embedded MATLAB Function, the name that appears at the bottom of the Embedded MATLAB Function block in Simulink.

Inside the **Embedded MATLAB Editor** is an edit window for editing the function that specifies the Embedded MATLAB Function block. A function header with the function name `fcn` is at the top of the edit window. The header specifies an argument to the function, `u`, and a return value, `y`.

- 2 Edit the function header line with the return values, function name, and argument as follows:

```
function [mean,stdev] = stats(vals)
```

The Embedded MATLAB function `stats` calculates a statistical mean and standard deviation for the values in the vector `vals`. The function header

declares `vals` to be an argument to the `stats` function and `mean` and `stdev` to be return values from the function.

- 3 In the **Embedded MATLAB Editor**, from the **File** menu, select **Save As Model** and save the model as `call_stats_block2`.

Saving the model updates the Simulink window, which now has the following appearance:

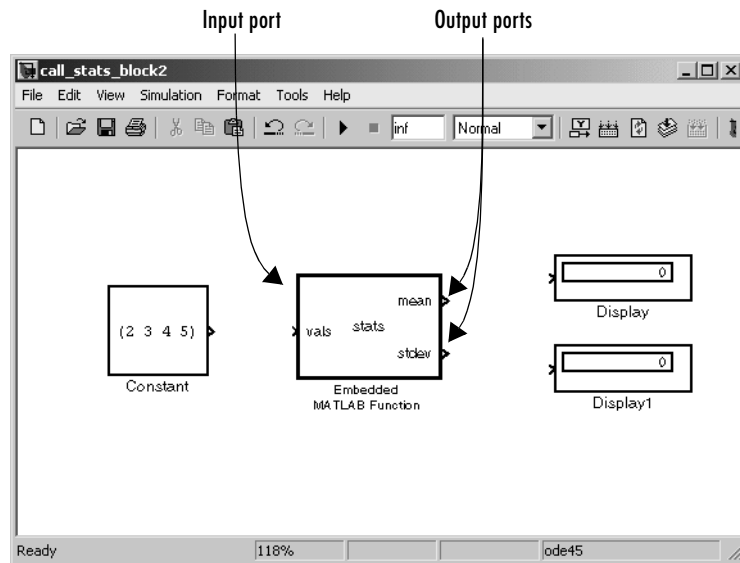

Changing the function header of the Embedded MATLAB Function block makes the following changes to the Embedded MATLAB Function block in the Simulink model:

- The function name in the middle of the block changes to `stats`.
- The argument `vals` appears as an input port to the block.
- The return values `mean` and `stdev` appear as output ports to the block.

- In the Simulink window, complete connections to the Embedded MATLAB Function block as shown.

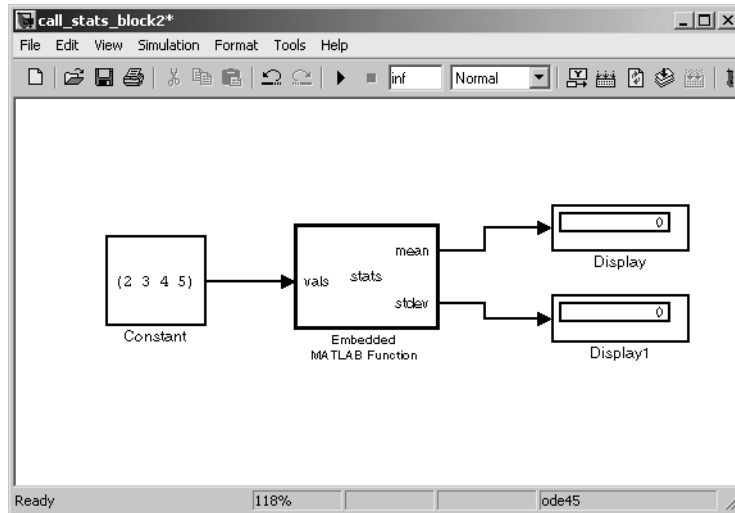

- In the **Embedded MATLAB Editor**, enter a line space after the function header and replace the default comment line with the following comment lines:

```
% calculates a statistical mean and a standard
% deviation for the values in vals.
```

You specify comments with a leading percent (%) character, just as you do in MATLAB.

- Enter a line space after the comments and replace the default function line `y = u;` with the following:

```
len = length(vals);
```

The function `length` is an example of a built-in function supported by the run-time function library for Embedded MATLAB Function blocks. This `length` works just like the MATLAB function `length`. It returns the vector length of its argument `vals`. However, when you simulate this model, Simulink generates C code for this function in the simulation application. Callable functions supported for Embedded MATLAB Function blocks are

listed in the topic “Embedded MATLAB Run-Time Function Library” in Simulink documentation.

The variable `len` is a local variable that is automatically typed as a scalar `double` because the Embedded MATLAB run-time library function, `length`, returns a scalar of type `double`. If you want, you can declare `len` to have a different type and size by changing the way you declare it in the function. See “Declaring Local Variables Implicitly” on page 15-52 for details about implicitly declaring local variables in an Embedded MATLAB Function block.

By default, implicitly declared local variables like `len` are temporary. They come into existence only when the function is called and cease to exist when the function is exited. You can make implicitly declared variables for a function persistent between calls by using the `persistent` statement.

See “Declaring Local Variables Implicitly” on page 15-52 for an example using the `persistent` statement.

- 7** Enter the following lines to calculate the value of `mean` and `stdev`:

```
mean = avg(vals,len);  
stdev = sqrt(sum((vals-avg(vals,len)).^2)/len);
```

`stats` stores the mean and standard deviation values for the values in `vals` in the variable `mean` and `stdev`, which are output by port to the Display blocks in the Simulink model. The line that calculates `mean` calls a subfunction, `avg`, that has not been defined yet. The line that calculates `stdev` calls the Embedded MATLAB run-time library functions `sqrt` and `sum`.

- 8** Enter the following line to plot the input values in `vals`.

```
plot(vals, '-+');
```

This line calls the function `plot` to plot the input values sent to `stats` against their vector indices. Because the Embedded MATLAB run-time library has no `plot` function, the Embedded MATLAB function cannot resolve this call with a subfunction or an Embedded MATLAB run-time

function. Instead, it replaces this call with a call to the MATLAB plot function in the generated code for the simulation target.

See “Calling MATLAB Functions” on page 15-57 for more details on using this mechanism to call MATLAB functions from Embedded MATLAB functions.

- 9 Enter a line space followed by the following lines for the subfunction avg, which is called in an earlier line.

```
function mean = avg(array,size)
mean = sum(array)/size;
```

These two lines define the subfunction avg. You are free to use subfunctions in Embedded MATLAB function code with single or multiple return values, just as you do in regular MATLAB functions.

The **Embedded MATLAB Editor** should now have the following appearance:

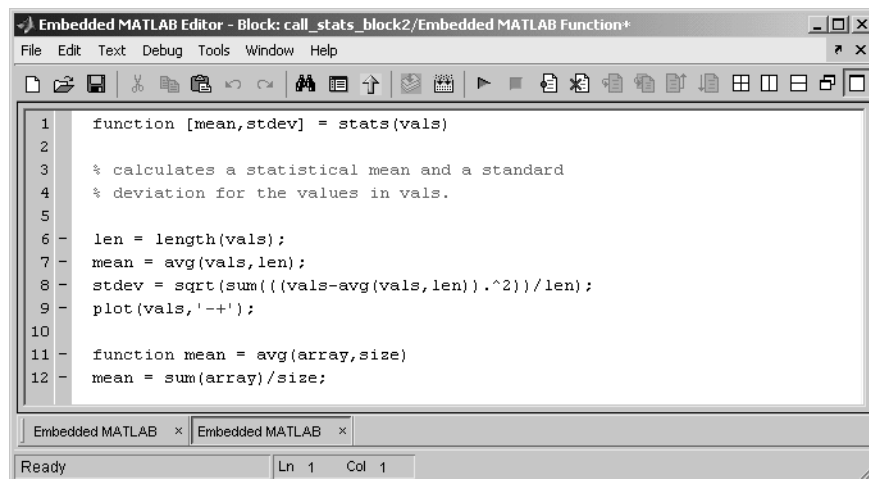

- 10 Save the model again as call_stats_block2.

Checking the Function for Errors

Once you finish specifying an Embedded MATLAB Function block in its Simulink model, use the built-in diagnostics of Embedded MATLAB Function blocks to test for syntax errors with the following procedure:

- 1 If not already open, open the `call_stats_block2` model that you save at the end of “Programming the Embedded MATLAB Function” on page 15-9, and double-click its Embedded MATLAB Function block `stats` to open it for editing.
- 2 In the **Embedded MATLAB Editor**, click the Build tool  to compile and build the example Simulink model.

If errors are found, the **Builder** window lists them. Otherwise, nothing happens.

- 3 For example, change the call to the subfunction `avg` to a call to a fictitious subfunction `aug` and then compile to see the following result.

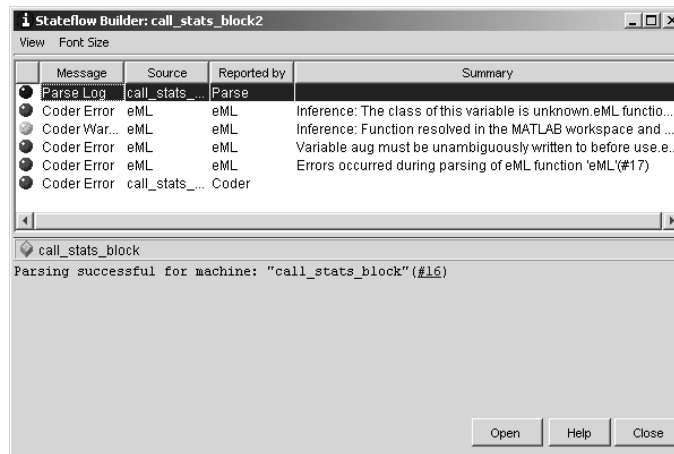

Each detected error begins with a red button. In this case, rows 2, 4, 5, and 6 have a red button.

- Click the first error line to highlight it and display information for it.

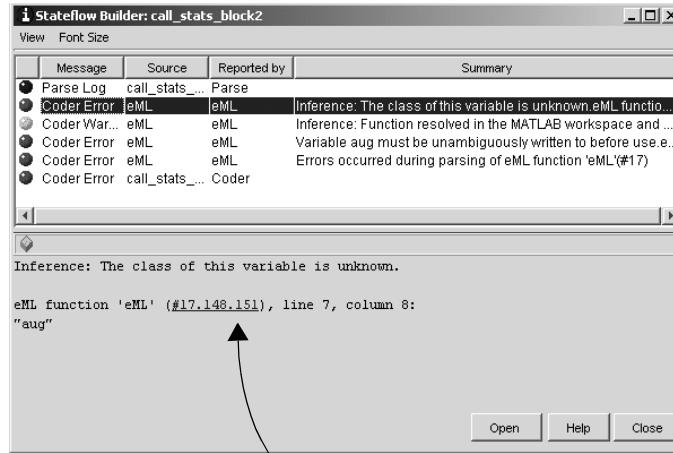

Click to display offending line in Embedded MATLAB Editor

- In the diagnostic message for the error appearing in the bottom pane of the **Build** window, click the link.

The offending line appears highlighted in the **Embedded MATLAB Editor**.

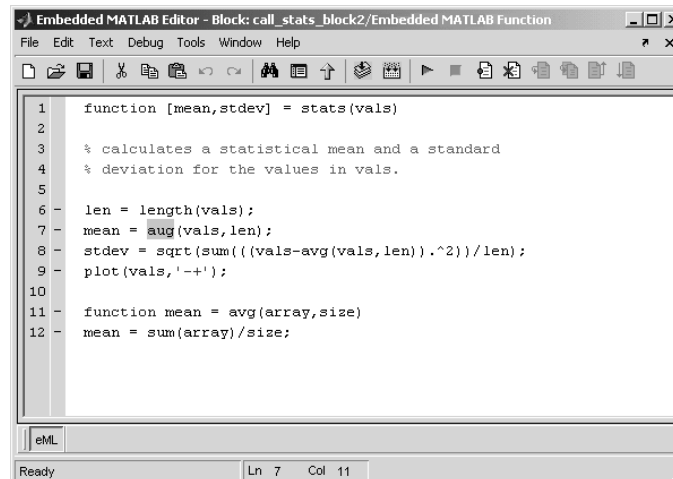

- 6 Correct the error and recompile.

Defining Inputs and Outputs

In the stats function header for the Embedded MATLAB Function block you define in “Programming the Embedded MATLAB Function” on page 15-9, the function argument `vals` is an input and `mean` and `stdev` are outputs. By default, function inputs and outputs inherit their data type and size from the Simulink signals attached to their ports. In this topic, you examine input and output data for the Embedded MATLAB Function block to verify that it inherits the correct type and size.

- 1 If not already open, open the `call_stats_block2` model that you save at the end of “Programming the Embedded MATLAB Function” on page 15-9, and double-click its Embedded MATLAB Function block `stats` to open it for editing.
- 2 In the **Embedded MATLAB Editor**, click the Explorer tool  to open the **Model Explorer**.

The **Model Explorer** window appears, as shown.

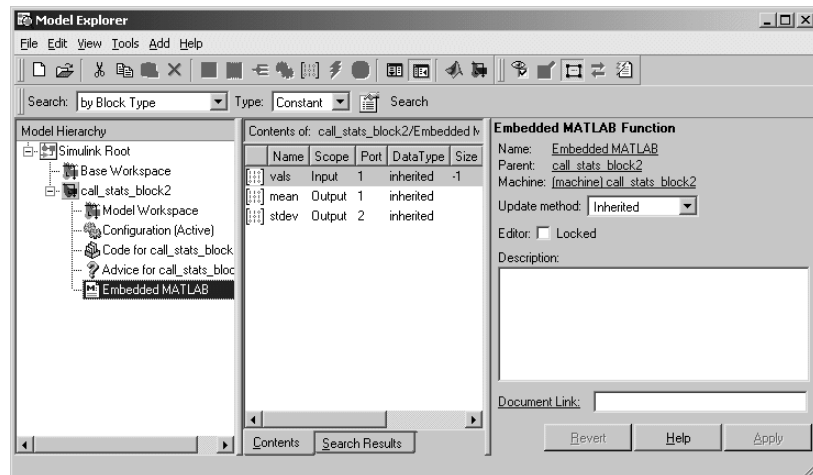

You use the **Model Explorer** to display and define arguments for Embedded MATLAB Function blocks. Notice that the Embedded MATLAB Function block Embedded MATLAB is highlighted in the left **Model Hierarchy** pane.

The **Contents** pane displays the argument `vals` and the return values `mean` and `stdev` that you have already created for the Embedded MATLAB Function block. Notice that `vals` is assigned a **Scope** of Input, which is short for **Input from Simulink**. `mean` and `stdev` are assigned the **Scope** of Output, which is short for **Output to Simulink**.

- 3 In the **Contents** pane of the **Model Explorer** window, click anywhere in the row for `vals` to highlight it, as shown.

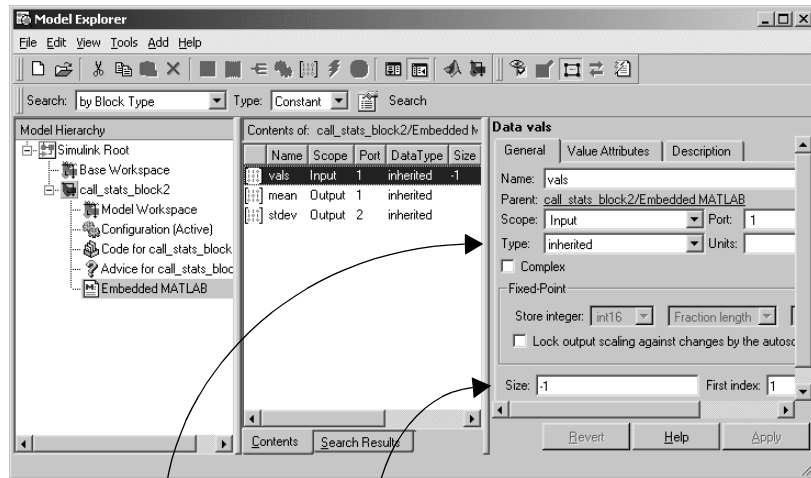

Inherited type

Inherited size

The right pane displays the **Data** properties dialog box for `vals`. By default, the type and size of input and output arguments are inherited from the Simulink signals attached to each input or output port. Inheritance of type is specified by setting **Type** to Inherited. Inheritance of size is specified by setting **Size** to -1.

The actual inherited values for size and type are set during compilation of the model, and are reported in the **CompiledType** and **CompiledSize**

columns of the **Contents** pane. You compile and build the model by clicking the Build tool , which you do in “Checking the Function for Errors” on page 15-15 to check the Embedded MATLAB function for errors.

If you want, you can specify the type of an input or output argument directly by selecting a type in the **Type** field of the **Data** properties dialog box, for example, `double`. You can also specify the size of an input or output argument directly by entering an expression in the **Size** field of the **Data** properties dialog box for the argument. For example, you can enter `[2 3]` in the **Size** field to size `vals` as a 2-by-3 matrix. See “Typing Function Arguments” on page 15-39 and “Sizing Function Arguments” on page 15-45 for more information on the expressions that you can enter for type and size.

Note The default first index for any arrays that you add to an Embedded MATLAB Function block function is 1, just as it would be in MATLAB.

Debugging an Embedded MATLAB Function

In “Creating an Example Embedded MATLAB Function” on page 15-7, you create and specify an example Simulink model with an Embedded MATLAB Function block. You use this block to specify an Embedded MATLAB function stats that calculates the mean and standard deviation for a set of input values. In this section, you debug stats in the example model.

Use the following topics to learn how to debug an Embedded MATLAB function in Simulink:

- “Debugging the Function in Simulation” on page 15-20 — Executes the model in simulation and tests the Embedded MATLAB function stats.
- “Watching Function Variables During Simulation” on page 15-27 — Describes tools that you can use to view the values of Embedded MATLAB variables during simulation.

Debugging the Function in Simulation

You can debug your Embedded MATLAB Function block just like you can debug a function in MATLAB. In simulation, you test your Embedded MATLAB functions for run-time errors with tools similar to the MATLAB debugging tools.

When you start simulation of your model, Simulink checks to see if the Embedded MATLAB Function block has been built since creation, or since a change has been made to the block. If not, it performs the build described in “Checking the Function for Errors” on page 15-15. If no diagnostic errors are found, Simulink begins the simulation of your model.

Use the following procedure to debug the stats Embedded MATLAB function during simulation of the model:

- 1 If not already open, open the `call_stats_block2` model that you save at the end of “Programming the Embedded MATLAB Function” on page 15-9, and double-click its Embedded MATLAB Function block stats to open it for editing in the **Embedded MATLAB Editor**.

- 2 In the **Embedded MATLAB Editor**, in the left margin of line 6, click the dash (-) character.

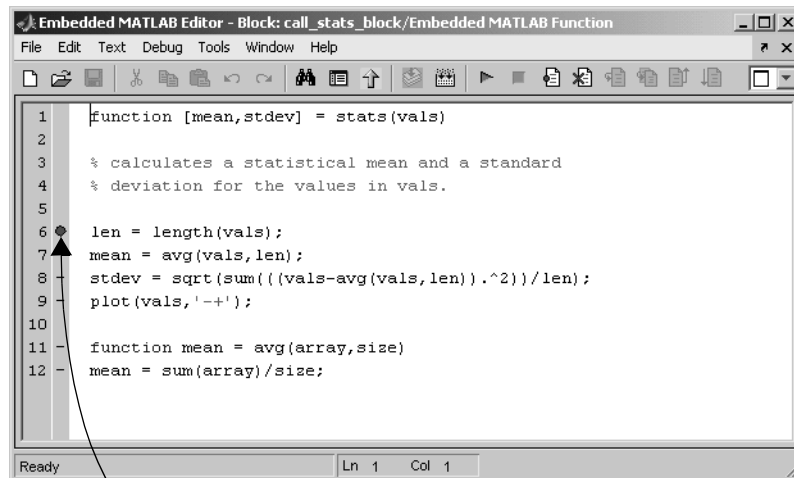

Breakpoint indicator

A small red ball appears in the margin of line 6, indicating that you have set a breakpoint. You can also use the Set/Clear Breakpoint tool  to insert the breakpoint on the line where the cursor is positioned.

- 3 Click the Start Simulation tool  to begin simulating the model.

If you get any errors or warnings, make corrections before you try to simulate again. Otherwise, simulation pauses when execution reaches the

breakpoint you set. This is indicated by a small green arrow in the left margin, as shown.

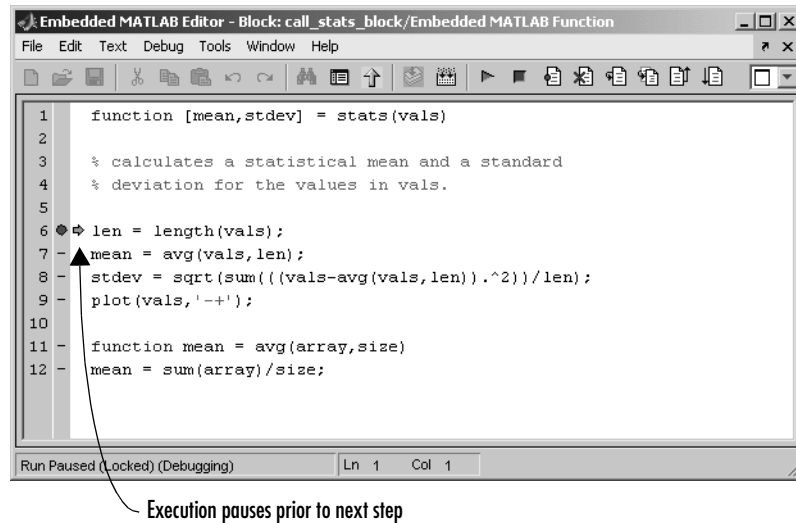

- 4 In the **Embedded MATLAB Editor** window, click the Step tool  to advance execution one line to line 7.

The execution arrow advances to line 7 of stats.

You can also step execution by entering `dbstep` at the Command Line Debugger. See “Watching with the Command Line Debugger” on page 15-28 for a description of the Command Line Debugger in MATLAB.

Notice that line 7 calls the subfunction `avg`. If you click Step here, execution advances to line 8, past the execution of the subfunction `avg`. To track execution of the lines in the subfunction `avg`, you need to click the Step In tool.

- 5 Click the Step In tool  to advance execution to the first line of the called subfunction avg, as shown.

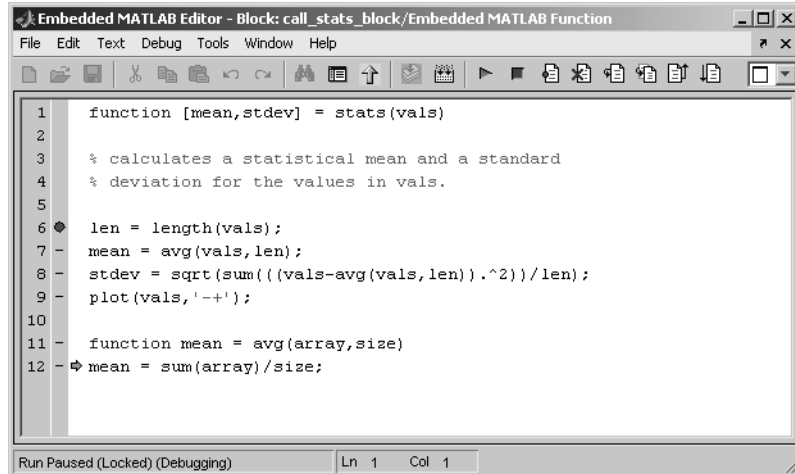

```
Embedded MATLAB Editor - Block: call_stats_block/Embedded MATLAB Function
File Edit Text Debug Tools Window Help
[Icons]
1 function [mean, stdev] = stats(vals)
2
3 % calculates a statistical mean and a standard
4 % deviation for the values in vals.
5
6 len = length(vals);
7 mean = avg(vals, len);
8 stdev = sqrt(sum((vals-avg(vals, len)).^2)/len);
9 plot(vals, '-+');
10
11 function mean = avg(array, size)
12 mean = sum(array)/size;
```

Run Paused (Locked) (Debugging) Ln 1 Col 1

Once you are in a subfunction, you can use the Step or Step In tool to advance execution. If the subfunction calls another subfunction, use the Step In tool to step into it. If you want to execute the remaining lines of the subfunction, click the Step Out tool .

- 6 Click the Step tool to execute the only line in the subfunction avg.

The subfunction `avg` finishes its execution, and you see a green arrow pointing down under its last line as shown.

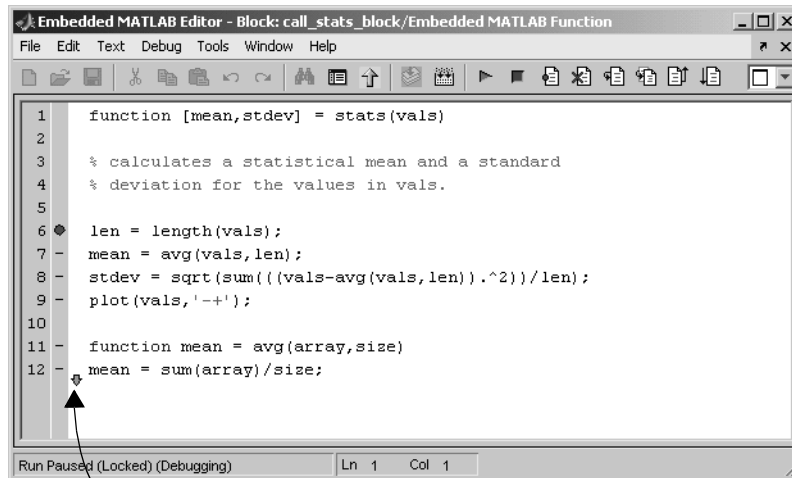

Subfunction completed

7 Click the Step tool to return to the function `stats`.

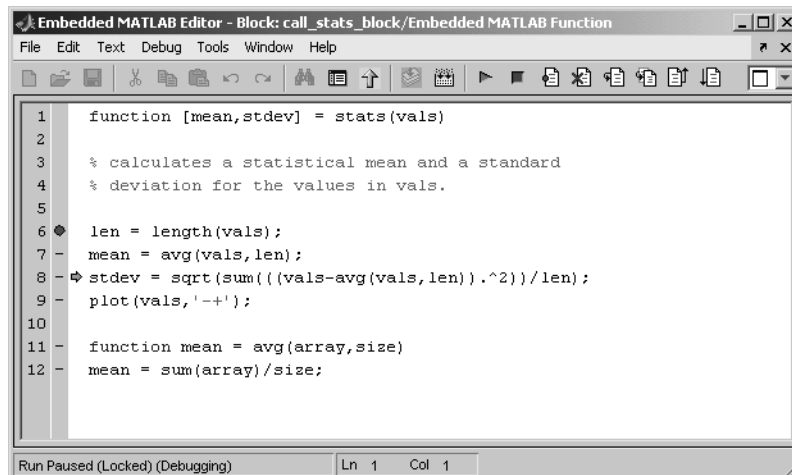

Execution advances to the line after to the call to the subfunction avg, line 8.

- 8 Click **Step** twice to execute line 8 and the plot function in line 9.

The plot function executes in MATLAB, and you see the following plot.

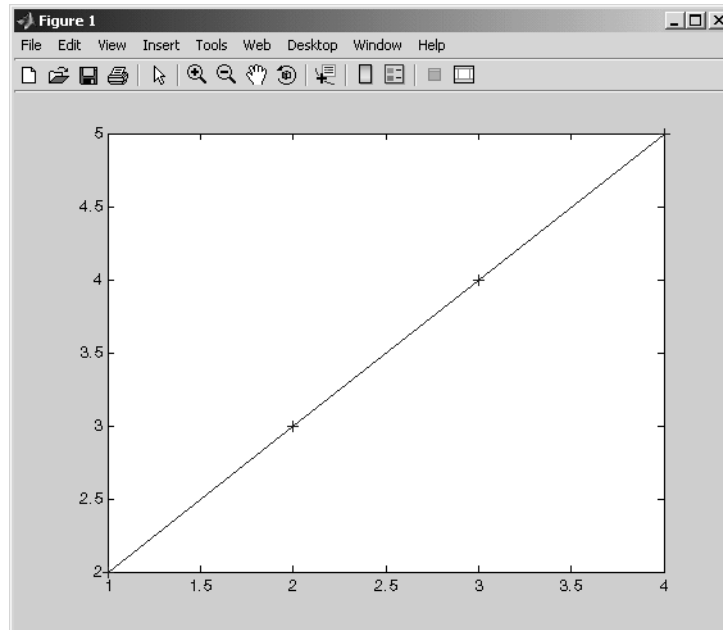

In the **Embedded MATLAB Editor**, a green arrow points down under line 9, indicating the completion of the function stats.

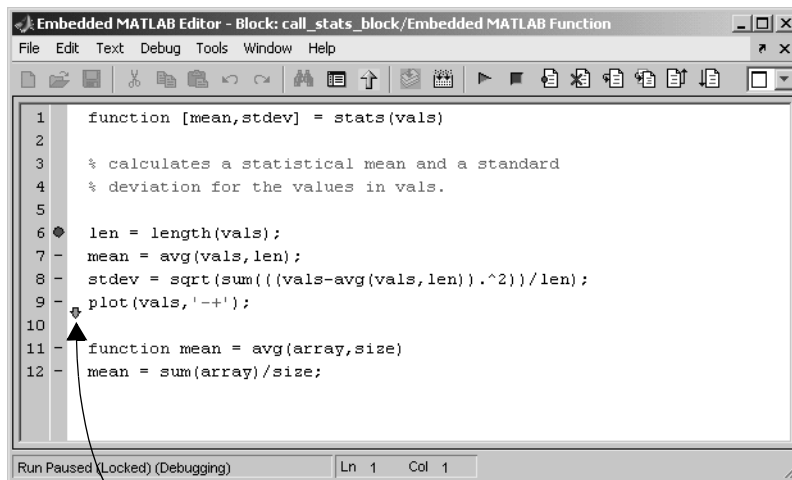

Function completed arrow

- 9 Click the Continue tool  to continue execution of the model.

At any point in a function, you can advance through the execution of the remaining lines of the function with the Continue tool. If you are at the end of the function, clicking the Step tool accomplishes the same thing.

You can also continue execution by entering `dbcont` at the Command Line Debugger. See “Watching with the Command Line Debugger” on page 15-28 for a description of the Command Line Debugger in MATLAB.

In the Simulink window, the computed values of mean and stdev now appear in the Display blocks.

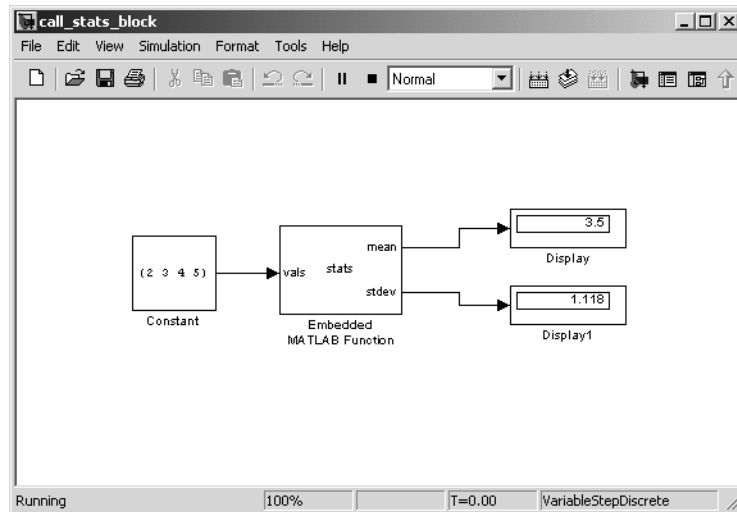

10 In the **Embedded MATLAB Editor**, click the Exit Debug Mode tool  to stop simulation.

Watching Function Variables During Simulation

While you are simulating the function of an Embedded MATLAB Function block, you can use several tools to keep track of variable values in the function. These tools are described in the topics that follow.

Watching with the Interactive Display

To display the value of a variable in the function of an Embedded MATLAB Function block during simulation, in the **Embedded MATLAB Editor**, place the mouse cursor over the variable text and observe the pop-up display. For example, to watch the variable `len` during simulation, place the mouse cursor

over the text `len` in line 6 for at least a second. The value of `len` appears adjacent to the cursor, as shown:

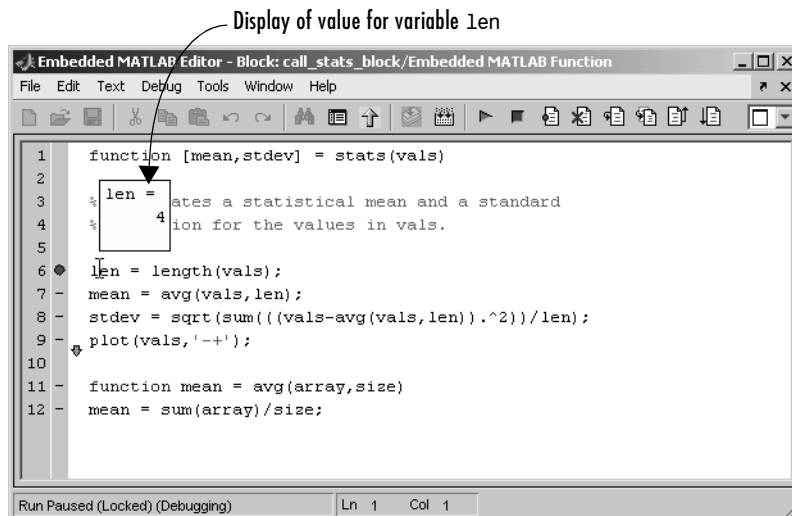

You can display the value for any variable in the Embedded MATLAB function in this way, no matter where it appears in the function.

Watching with the Command Line Debugger

You can report the values for an Embedded MATLAB function variable with the Command Line Debugger utility in the MATLAB window during simulation. When you reach a breakpoint, press **Enter** in the MATLAB window and the Command Line Debugger prompt, `debug>>`, appears. At this prompt, you can see the value of a variable defined for the Embedded MATLAB Function block by entering its name:

```
debug>> stdev
```

```
1.1180
```

```
debug>>
```

The Command Line Debugger also provides the following commands during simulation:

Command	Description
<code>dbstep</code>	Advance to next program step after a breakpoint is encountered.
<code>dbcont</code>	Continue execution to next breakpoint.
<code>dbquit</code>	Stop simulation of the model. Press Enter after this command to return the MATLAB prompt.
<code>help</code>	Display help for command line debugging.
<code>print x</code>	Display the value of the variable <code>x</code> . If <code>x</code> is a vector or matrix, you can also index into <code>x</code> . For example, <code>x(1,2)</code> .
<code>save</code>	Saves all variables to the specified file. Follows the syntax of the MATLAB <code>save</code> command. To retrieve variables to the MATLAB base workspace, use <code>load</code> command after simulation has been ended.
<code>whos</code>	Display the size and class (type) of all variables in the scope of the halted Embedded MATLAB Function block.

You can issue any other MATLAB command at the `debug>>` prompt, but the results are executed in the workspace of the Embedded MATLAB Function block. To issue a command in the MATLAB base workspace at the `debug>>` prompt, use the `evalin` command with the first argument 'base' followed by the second argument command string, for example, `evalin('base','whos')`. To return to the MATLAB base workspace, use the `dbquit` command.

Watching with MATLAB

You can display the execution result of an Embedded MATLAB function line by omitting the terminating semicolon. If you do, execution results for the line are echoed to the MATLAB window during simulation.

The Embedded MATLAB Function Editor

You edit an Embedded MATLAB function to specify its function header and body. When you open an unspecified Embedded MATLAB function for editing, it has the following default appearance in the **Embedded MATLAB Editor**:

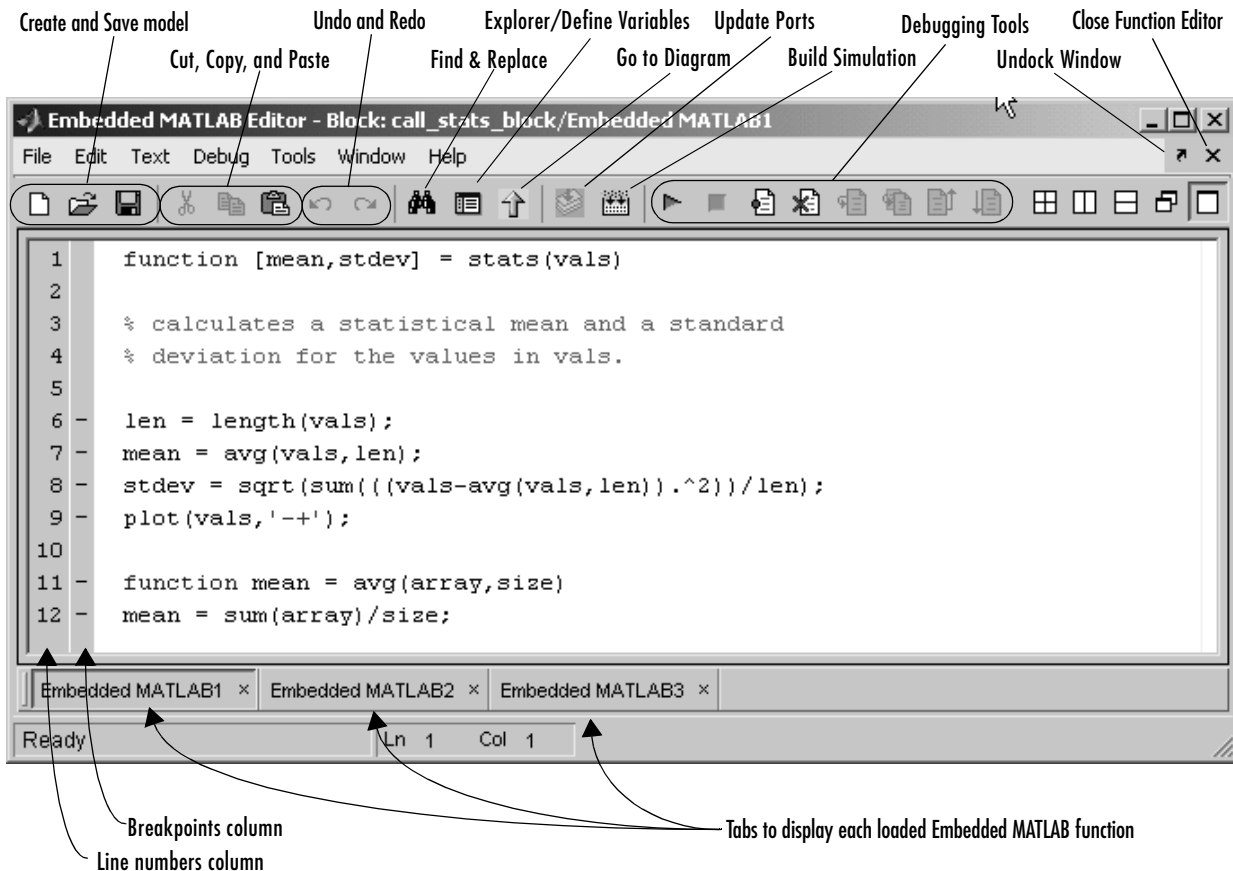

This section provides the following topics to describe tools for editing Embedded MATLAB functions in the **Embedded MATLAB Editor**:

- “Changing the Embedded MATLAB Editor” on page 15-31 — Tools to alter the editor for the sake of convenience and utility



- “Editing the Embedded MATLAB Function” on page 15-34 — Tools to edit the contents of the function
- “Defining Embedded MATLAB Function Arguments” on page 15-36 — Tools to go to in the **Model Explorer** tool or the Simulink model to set the size, type, or source of an input or output argument
- “Debugging Embedded MATLAB Functions” on page 15-37 — Tools to debug the Embedded MATLAB function during simulation of the model



Changing the Embedded MATLAB Editor

Use the tools described in the following topics to change the appearance of the **Embedded MATLAB Editor** to add convenience and utility to its use.

Displaying Embedded MATLAB Function Windows

By default, if you have more than one Embedded MATLAB function loaded in the **Embedded MATLAB Editor**, only the most recently loaded is displayed. Editing windows for previously loaded functions are accessed individually with tabs in the document bar. You can display the editing windows for all loaded functions simultaneously with one of the following selections from the **Window** menu:

Tool Button	Description
 Tile	Tile all loaded Embedded MATLAB windows into an adjustable matrix of windows. When you select the option, an array of squares representing the tiled windows is available as a submenu. Select an appropriate array of windows.
 Left/Right Split	Display the selected window and the next most recently loaded Embedded MATLAB function at full height, side by side.
 Top/Bottom Split	Display the selected window and the next most recently loaded Embedded MATLAB function at full width, top to bottom.

Tool Button	Description
 Float	Display the loaded Embedded MATLAB functions in separate cascading and overlapping windows of the same size.
 Maximize	Display the Embedded MATLAB function in current focus at the full width and height of the editor. This is the default setting.
 Undock Embedded MATLAB	Create a separate editor for the function in current focus. To redock the function back into the Embedded MATLAB Editor , from the Desktop menu of the undocked window, select Dock <function_name> .

Moving the Document Bar

When you edit an Embedded MATLAB function, it is displayed as a window in the **Embedded MATLAB Editor**. Because you can open more than one Embedded MATLAB function in the **Embedded MATLAB Editor**, a tab is added for the window in the document bar. Each tab contains the name of an Embedded MATLAB Function block loaded for editing. By default, the document bar appears at the bottom of the **Embedded MATLAB Editor**. If you want to edit an Embedded MATLAB function not in focus, click its tab.

You can change the location of the document bar to appear at the top of, to the left of, or to the right of the Embedded MATLAB function window, or you can make it disappear altogether, as follows:

- 1 From the **Desktop** menu, select **Document Bar**.

In the resulting submenu, a dot appears in front of the current selection. The default selection is **Bottom**.

- 2 From the resulting submenu, select **Top**, **Bottom**, **Right**, **Left**, or **Hide**.

Eliminating the Toolbar

By default, the **Embedded MATLAB Editor** has a toolbar with shortcuts to tools that you can access from the menu. To eliminate the toolbar,

- 1 Select the **Desktop** menu.

The **Toolbar** option under **Desktop** is checked, to indicate the appearance of the toolbar.

- 2 Under **Desktop**, select **Toolbar**.

The toolbar disappears.

- 3 Select the **Desktop** menu again.

The **Toolbar** option under **Desktop** is no longer checked. Select it to make the toolbar visible again.

Setting Preferences

You can choose preferences for the **Embedded MATLAB Editor**, such as font size, tab size, and so on, as follows:

- 1 From the **File** menu, select **Preferences**.

The MATLAB **Preferences** dialog box appears.

- 2 Change preferences in pages accessed only through the following nodes:



- **Fonts**
- **Colors**
- **Display** (under **Editor/Debugger**)
- **Keyboard & Indenting** (under **Editor/Debugger**)

Note The **Embedded MATLAB Editor** is a derivation of the MATLAB editor you use to edit M-files in MATLAB. The preference changes that you specify are made to the MATLAB editor.

Editing the Embedded MATLAB Function

Use the tools in the following topics to edit an Embedded MATLAB function in the **Embedded MATLAB Editor**:

Undoing and Redoing Operations

Tool Button	Description
 Undo	Undo the effects of the preceding operation. Alternatively, from the Edit menu, select Undo .
 Redo	Redo the effects of the most recently undone operation. Alternatively, from the Edit menu, select Redo .

Comment and Uncomment Embedded MATLAB Function Lines

You can comment text or uncomment commented text as follows:

- To turn selected function text lines into commented text lines, from the **Text** menu, select **Comment**.
- To turn selected comment text lines into function text lines, from the **Text** menu, select **UnComment**.

Any text selected on a line, or the presence of the text cursor, selects the line.

Going to a Specified Line of the Embedded MATLAB Function

To place the text cursor at the beginning of a specified line, from the **Edit** menu, select **Go to Line**. In the resulting dialog box, enter the line number and click **OK**.

Searching for and Replacing Text in Embedded MATLAB Functions

You can use the Find & Replace tool to search and replace text in the **Embedded MATLAB Editor** as follows.

- 1 Click the Find & Replace toolbar button .

The **Find & Replace** dialog box appears.

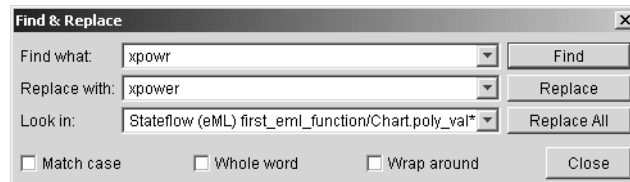

By default, the **Look in** field is set to search the current Embedded MATLAB function, but you can select from any Embedded MATLAB functions that you have open for editing.



- 2 Enter the text that you want to search for in the **Find what** field.
- 3 Modify the text you want to search for by checking any or all of the following:
 - **Match case** — The found text must match the case of the text in the **Find what** field.
 - **Whole word** — The found text must be a whole word and not part of a larger word.
 - **Wrap around** — Continue searching after reaching the bottom of the editor. Otherwise, stop searching.
- 4 Enter the text that you want to substitute in the **Replace with** field.
- 5 Click the **Find** button to find a single occurrence of the text in the **Find what** field.

If the text is present in the **Embedded MATLAB Editor**, it is highlighted with a gray background.

- 6 Click the **Replace** button to replace highlighted text in the editor with the text specified for the **Replace with** field.
- 7 Click the **Replace All** button to replace every occurrence of the text specified in the **Find what** field with the text specified for the **Replace with** field.

Defining Embedded MATLAB Function Arguments









Once you edit the Embedded MATLAB function, you might need to set the size, type, or source of an input or output argument. Do this in the **Model Explorer**, or the Simulink model, which you can enter from the **Embedded MATLAB Editor** with the following tools:



Tool Button	Description
 Explore/Define Data	Go to the Model Explorer to add or modify arguments for the current function. Alternatively, from the Tools menu, select Explore .
 Goto Diagram Editor	Displays the Embedded MATLAB function in its native diagram without closing the Embedded MATLAB Editor .
 Update Ports	Updates the ports of the Embedded MATLAB Function block with the latest changes made to the function argument and return values without closing the Embedded MATLAB Editor .

See “Defining Inputs and Outputs” on page 15-17 for an example of defining an input argument for an Embedded MATLAB Function block.

Debugging Embedded MATLAB Functions

Use the following tools during an Embedded MATLAB function debugging session:

Tool Button	Description
	<p>A breakpoint indicator. To set a breakpoint for a line of function code, click the hyphen character (-) in the breakpoints column for the line. A breakpoint indicator appears in place of the hyphen. Click the breakpoint indicator to clear the breakpoint.</p>
 Build	<p>Check for errors and build a simulation application (if no errors are found) for the model containing this Embedded MATLAB function.</p>
 Start Simulation	<p>Start simulation of the model containing the Embedded MATLAB function. Alternatively, press F5, or, from the Debug menu, select Start.</p>
 Stop Simulation	<p>Stop simulation of the model containing the Embedded MATLAB function. You can also select Exit debug mode from the Debug menu if execution is paused at a breakpoint.</p>
 Pause Simulation	<p>Temporarily stop execution during simulation. To continue with execution, click the Start Simulation tool .</p>
 Set/Clear Breakpoint	<p>Set a new breakpoint or clear an existing breakpoint for the selected Embedded MATLAB code line. The presence of the text cursor or highlighted text selects the line.</p>
 Clear All Breakpoints	<p>Clear all set breakpoints in the Embedded MATLAB function.</p>

Tool Button	Description
 Step	Step through the execution of the next Embedded MATLAB code line. This tool steps past function calls and does not enter called functions for line-by-line execution. You can use this tool only after execution has stopped at a breakpoint. Alternatively, press F11 , or, from the Debug menu, select Step .
 Step In	Step through the execution of the next Embedded MATLAB code line. If the line calls a subfunction, step into line-by-line execution of the subfunction. You can use this tool only after execution has stopped at a breakpoint.
 Step Out	Step out of line-by-line execution of the current subfunction to the line after the line that calls this subfunction. You can use this tool only after execution has stopped at a breakpoint.

See “Debugging the Function in Simulation” on page 15-20 for an example using some of these debugging tools.

Typing Function Arguments

In “Programming the Embedded MATLAB Function” on page 15-9, you create two output arguments and an input argument for an Embedded MATLAB Function block by entering them in its function header. This creates ports on the Embedded MATLAB Function block that you can attach to Simulink signals. You can select the type for each argument that you define for an Embedded MATLAB Function block. By default, they are assigned the type inherited. This means that type is assigned on the basis of the incoming or outgoing Simulink signal.

Examine the type for an argument in the **Model Explorer** as follows:

- 1 From the **Embedded MATLAB Editor**, click the Explorer tool .

The **Model Explorer** appears with the Embedded MATLAB Function block highlighted in the **Model Hierarchy** pane on the left.

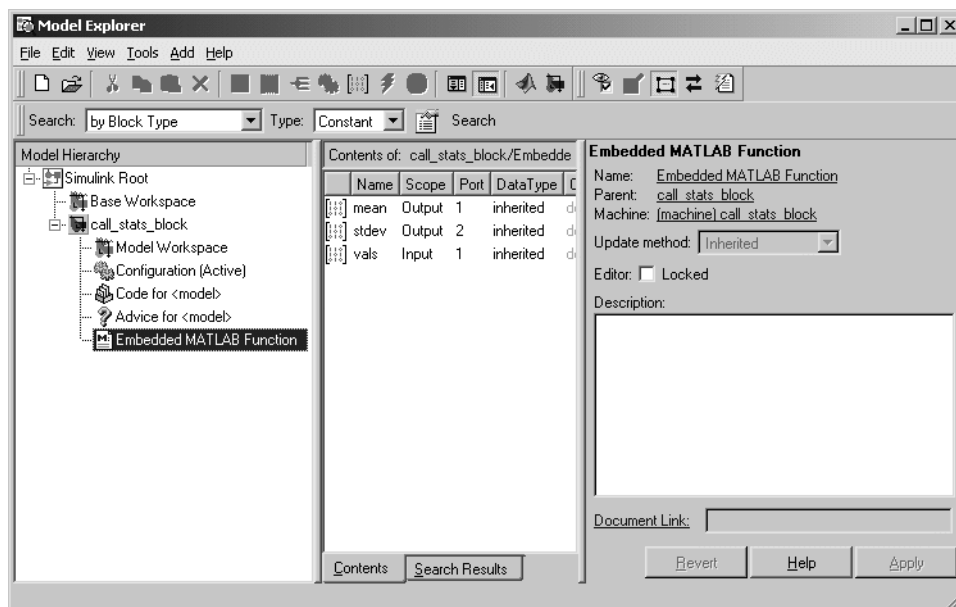

2 In the **Contents** pane, click on a data row to select it, as shown.

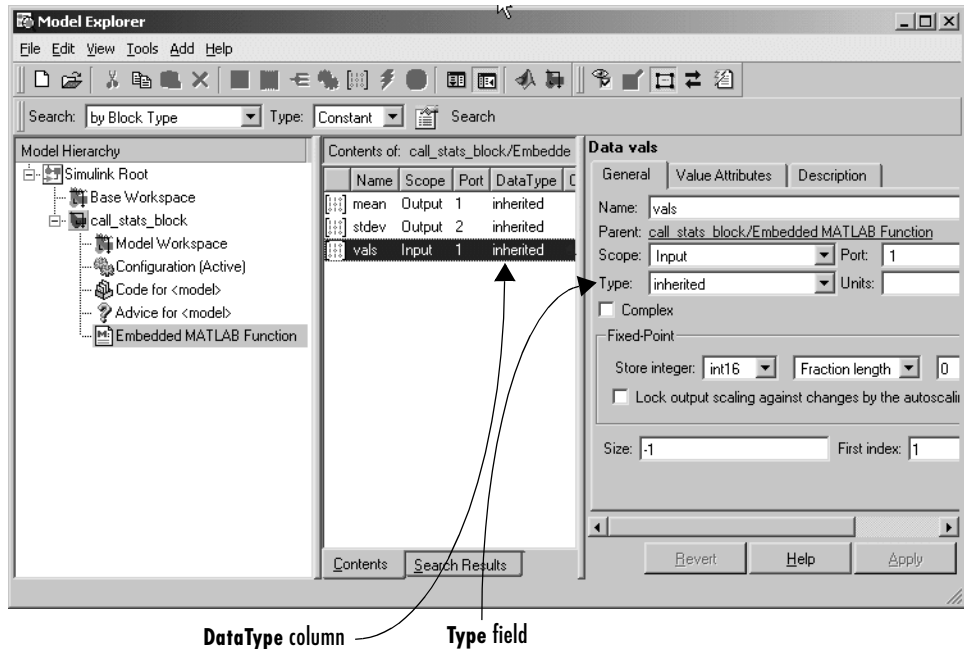

You specify the type of an argument in the **Type** field of the **Data** properties pane, as shown. You can also specify it in the **Contents** pane of the Model Explorer by clicking the cell in the **Type** column of the highlighted argument row and editing it.

The type of the arguments in the preceding example is **inherited**. This is the default type for all input and output data. Use the following topics to determine whether you want to keep the **inherited** type or specify the argument types yourself:

- “Inheriting Argument Data Types” on page 15-41 — Tell the Embedded MATLAB Function block to inherit the argument type from Simulink.
- “Selecting Types for Arguments” on page 15-42 — Select from a list of supported data types.
- “Specifying Argument Types with Expressions” on page 15-43 — Enter an expression with the type operator that returns the type of an existing variable.

Inheriting Argument Data Types

You can tell an Embedded MATLAB Function block to inherit the data type of an argument from Simulink by selecting **inherited** in the **Type** field for that data. In this case, the argument inherits its data type, including fixed-point types, from the Simulink signal that is connected to it. See “Selecting Types for Arguments” on page 15-42 for a list of supported data types.

Once you build the model, the **CompiledType** column of the **Model Explorer** gives the actual type used in the compiled simulation application. To conveniently compile and build the model from the **Embedded MATLAB Editor**, click the Build tool . In the following example, an Embedded Matlab Function block argument inherits its data type from an input signal of type double.

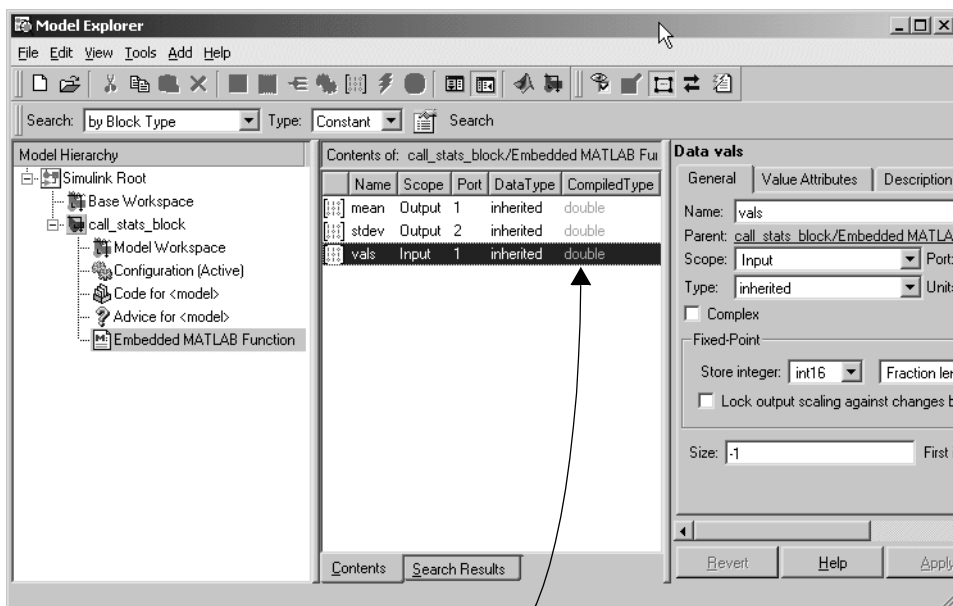

Actual compiled types

Inheriting the type of input data is successful in all cases. The inherited type of output data is inferred from diagram actions that store values in the specified output. In the preceding example, the variables `mean` and `stdev` are computed from operations with double operands, which yield results of type

double. If the expected type in Simulink matches the inferred type, inheritance is successful. In all other cases, a mismatch occurs during build time.

Note No input or output arguments with inherited types are allowed for Embedded MATLAB Function blocks in a library.

Selecting Types for Arguments

When you click on the down arrow of the **Type** field for an argument in its **Data** properties dialog box or in its row element in the **Model Explorer**, a selectable list of data types appears. You can directly specify the type of the data by selecting one of the following types:

Data Type	Description
double	64-bit double-precision floating point
single	32-bit single-precision floating point
int32	32-bit signed integer
int16	16-bit signed integer
int8	8-bit signed integer
uint32	32-bit unsigned integer
uint16	16-bit unsigned integer
uint8	8-bit unsigned integer
boolean	Boolean (1 = true; 0 = false)

Data Type	Description
fixpt	<p>Fixed-point data</p> <p>Specifying <code>fixpt</code> enables the Stored Integer and Scaling fields in the adjacent Fixed-Point field section, which are used to specify the fixed-point type.</p> <p>For fixed-point data, if an input or output fixed-point argument does not match its counterpart data in Simulink, a mismatch error results.</p>
inherited	<p>Inherit type of input or output data from Simulink</p> <p>See “Inheriting Argument Data Types” on page 15-41 for more details.</p>

Specifying Argument Types with Expressions

You can specify the type of an argument with an expression that you enter in the **Type** field of its Data properties dialog box as follows:

- 1 Click on the text area of the **Type** field to place a cursor in that field.
- 2 Enter an expression with the type operator that returns the type of a previously defined variable.

For example, if the variable `x` is already defined, enter `type(x)`. In this case, `x` can be another argument. `x` can be defined with any supported type, including the type `inherited`.

In the following example, the local variable `data` is specified with a **Data Type** of `type(vals)`. The input data `vals` inherits its type from a Constant block whose output signal is set to the type `uint8`.

Click the Build tool  to compile and build the model from the **Embedded MATLAB Editor**. When the model is compiled, the actual type of data appears in the **CompiledType** column in the **Contents** pane.

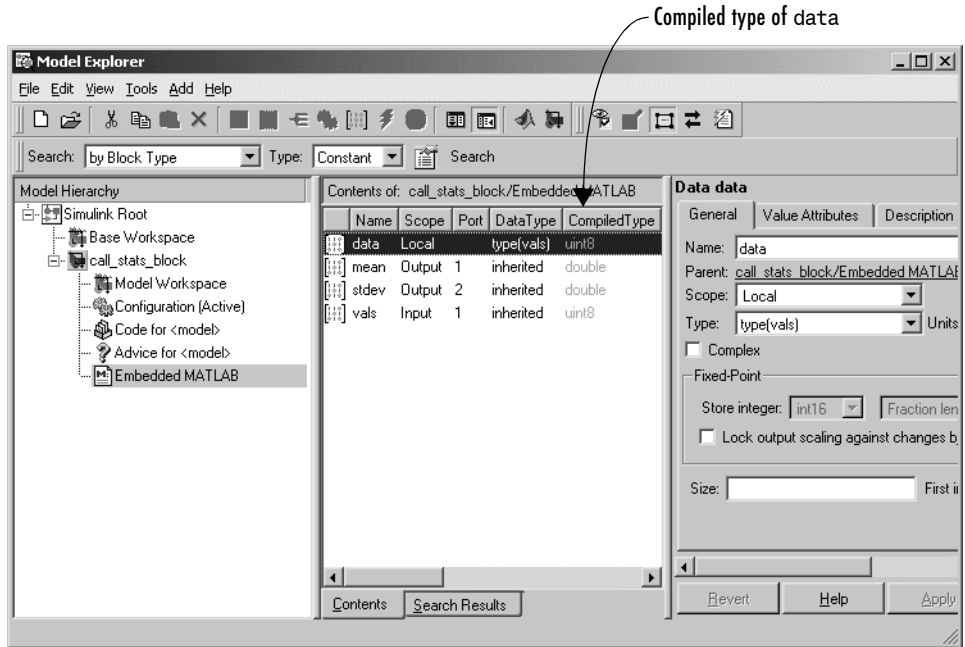

Sizing Function Arguments

In “Programming the Embedded MATLAB Function” on page 15-9, you create two output arguments and an input argument for an Embedded MATLAB Function block by entering them in its function header. This creates ports on the Embedded MATLAB Function block that you can attach to Simulink signals.

You can examine or specify the size of an argument in the **Model Explorer** as follows:

- 1 From the **Embedded MATLAB Editor**, click the Explorer tool .

The Model Explorer appears with the Embedded MATLAB Function block highlighted in the **Model Hierarchy** pane on the left.

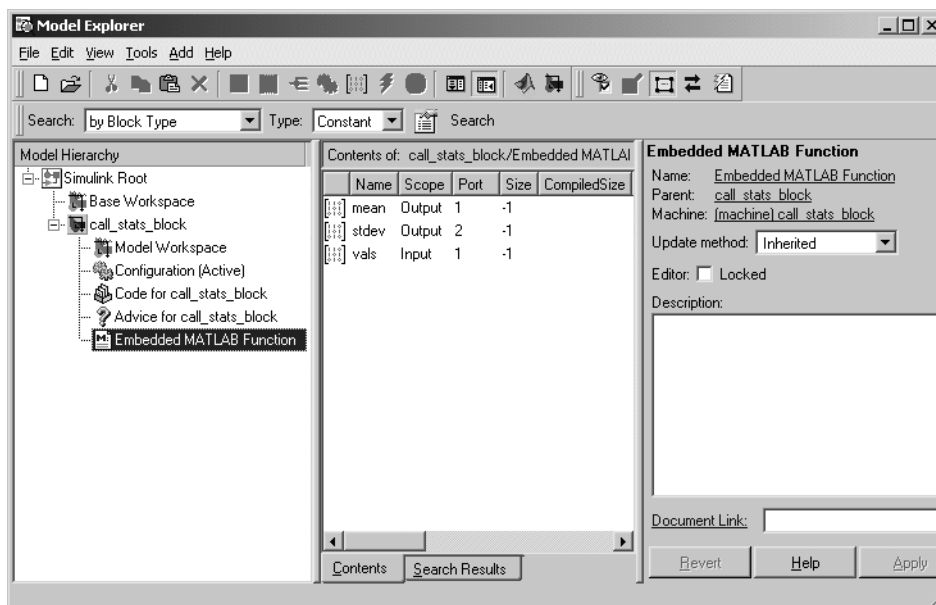

2 In the **Contents** pane, click a data row to select it.

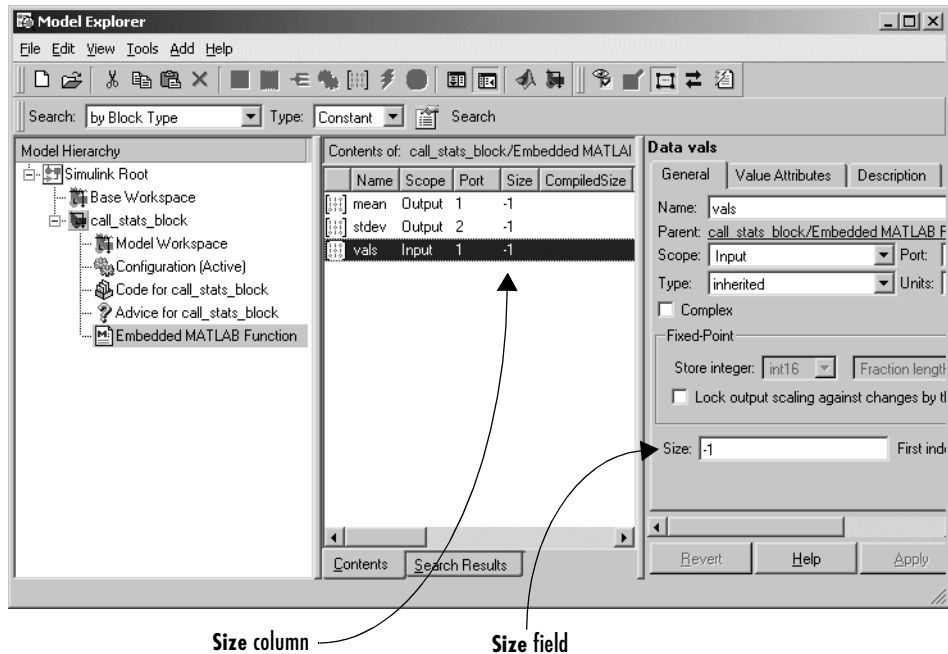

You specify the size of an argument in the **Model Explorer** in the **Size** field of the **Data** properties pane on the right. You can also specify it in the **Contents** pane of the **Model Explorer** by clicking the cell in the **Size** column of the highlighted argument row and editing it.

The size of the arguments in the preceding example is -1. This is the default size for inputs and outputs. It specifies that the size of the argument is inherited from the Simulink signal that connects to it. Use the following topics to determine whether you want to keep the **inherited** size or size the arguments yourself.

- “Inheriting Argument Sizes from Simulink” on page 15-47 — Tell the Embedded MATLAB Function block to inherit the size of the argument from the attached Simulink input or output.
- “Specifying Argument Sizes with Expressions” on page 15-48 — Use an expression that evaluates to the correct size.

Inheriting Argument Sizes from Simulink

You can tell an Embedded MATLAB Function block to inherit the size of an argument from Simulink by entering a **-1** in its **Size** field in the **Model Explorer**. This is the default setting for arguments that you add in the function header of an Embedded MATLAB Function block.

Once you compile the model, the **CompiledSize** column of the Model Explorer gives the actual size used in the compiled simulation application. To conveniently compile the model from the **Embedded MATLAB Editor**, click the Build tool .

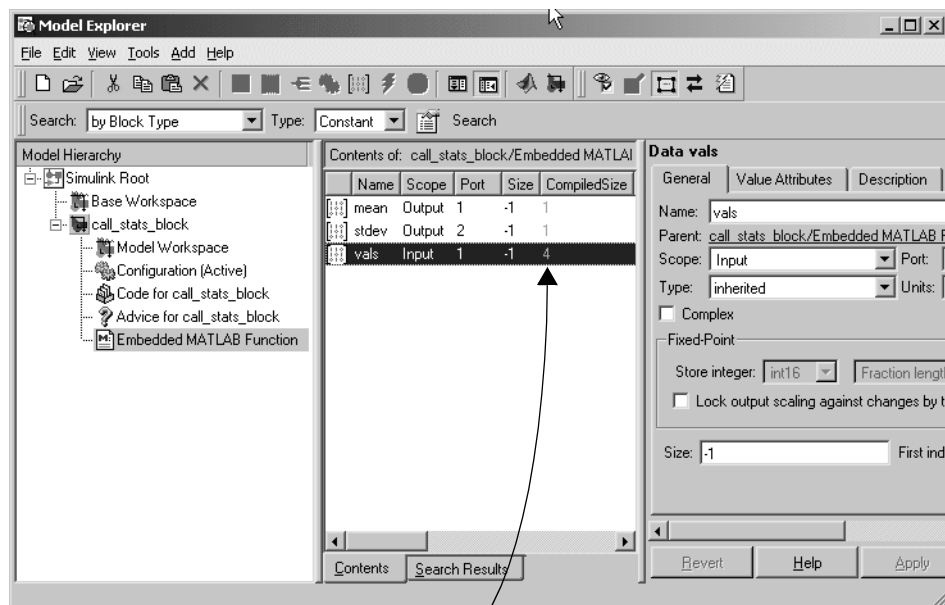

Sizing of input arguments is complete for all cases. The size of an output argument is the size of the value that is assigned to it. If the expected size in Simulink does not match, a mismatch error occurs during compilation of the model.

Note No arguments with inherited sizes are allowed for Embedded MATLAB Function blocks in a library.

Specifying Argument Sizes with Expressions

You specify the size of an argument or return value for an Embedded MATLAB Function block in the **Size** field of the **Model Explorer** in [row column] format. For example, a value of [2 4] defines a 2-by-4 matrix. To define a row vector of size 5, set the **Size** field to [1 5]. To define a column vector of size 6, set the **Size** field to [6 1] or just 6. You can enter a MATLAB expression for each [row column] element in the **Size** field. Each expression can use one or more of the following:

- Numeric constants — For example, 1, 3, 7.54, and so on.
- Arithmetic operators — Restricted to +, -, *, and /.
- Parameter arguments — Embedded MATLAB Function block arguments declared in the Model Explorer with the scope **Parameter**. These arguments take their value from a Simulink parameter of the same name for a parent subsystem or the MATLAB base workspace. See “Parameter Arguments in Embedded MATLAB Functions” on page 15-50 for details.
- Calls to the MATLAB functions `min`, `max`, and `size`

The following examples are valid expressions for the **Size** field for an argument:

```
k+1
size(x)
min(size(y),k)
```

where `k`, `x`, and `y` are variables of scope **Parameter**.

Once you build the model, the **CompiledSize** column of the Model Explorer gives the actual size used in the compiled simulation application. In the

following example, the Embedded MATLAB Function block input argument `uin` is sized by the expression `x+y`.

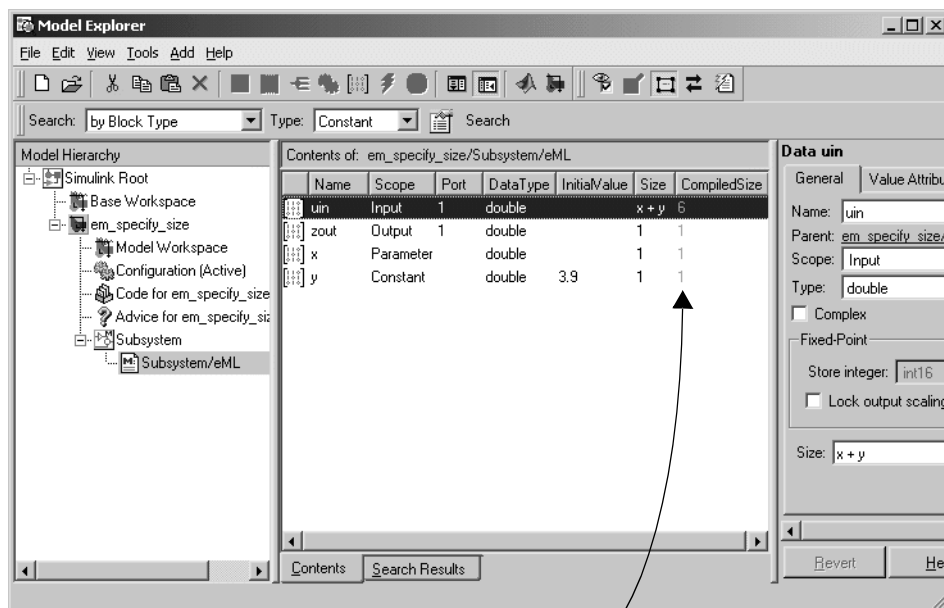

Actual compiled size

`x` is a local variable with scope **Parameter** that takes its value from the parameter `x` for the masked subsystem containing the Embedded MATLAB Function block. Its value is initialized to 2.1 (not shown). `y` is a local variable of Constant scope initialized to 3.9. `x+y` is therefore 6.

Parameter Arguments in Embedded MATLAB Functions

Parameter arguments for Embedded MATLAB Function blocks do not take their value from a Simulink signal. Instead, they take their value from a parameter of a parent Simulink masked subsystem or a variable in the MATLAB base workspace. This allows you to pass a read-only constant in Simulink to the Embedded MATLAB Function block.

Use the following procedure to add a parameter argument to a function for an Embedded MATLAB Function block.

- 1 In the **Embedded MATLAB Editor**, add an argument to the function header of the Embedded MATLAB Function block.

The name of the argument must be identical to the name of the masked subsystem parameter or MATLAB variable that you want to pass to the Embedded MATLAB Function block. For information on declaring parameters for masked subsystems in Simulink, see “The Mask Editor” on page 12-12.

- 2 Bring focus to the Embedded MATLAB Function block in Simulink.

The new argument appears as a new input port in the Simulink diagram.

- 3 In the **Embedded MATLAB Editor**, click the Explore tool .

The **Model Explorer** appears with the Embedded MATLAB Function block highlighted in the **Model Hierarchy** pane.

- 4 In the **Contents** pane, click anywhere in the row for the new argument to highlight it.
- 5 In the highlighted row, click the entry in the **Scope** column and select the value **Parameter**.

You can also make this change in the **Scope** field of the **Data** properties dialog box on the far right.

- 6 After you apply the scope change in the **Model Explorer**, examine the Embedded MATLAB Function block in Simulink.

The new port no longer appears for the parameter argument.

Note Parameter arguments appear as arguments in the function header of the Embedded MATLAB Function block to maintain MATLAB consistency. This lets you test functions in an Embedded MATLAB Function block by copying and pasting them to MATLAB.

Local Variables in Embedded MATLAB Functions

Embedded MATLAB functions support a subset of MATLAB data types. Normally, you declare function arguments in the **Model Explorer** and define local variables implicitly in the function code. This section lists and describes the data types supported in Embedded MATLAB functions for local variables along with any exceptions or deviations from MATLAB behavior:

- “Declaring Local Variables Implicitly” on page 15-52 — How to create variables for an Embedded MATLAB function that are not persistent by default and how to use them
- “Declaring Local Complex Variables Implicitly” on page 15-53 — How to create complex variables for an Embedded MATLAB function that is nonpersistent by default and rules for their use

Declaring Local Variables Implicitly

You declare variables implicitly in Embedded MATLAB functions by specifying constants and making initial assignments. By default, this type of variable does not persist between function calls. It is recreated for each function call and has no identity or value outside the Embedded MATLAB function. You can, however, make this variable persistent with a `persistent` statement at the top of the function body before the first use of the variable. For example, to declare the variable `abc` persistent, enter the following line right after the function header and comments:

```
persistent abc;
```

You declare variables implicitly in the function body of Embedded MATLAB functions in the following ways:

- By using constants (for example, 3, 5.7, and so on)
Constants have the MATLAB type `double`.
- By declaring variables in an Embedded MATLAB function with a first use in a simple assignment

The first use of a variable must initialize its value, its type, and its size. For example, the following initial assignments declare variables in an Embedded MATLAB function:

```
a = 14.7; %a is a scalar of type double.  
b = a; %because a is of type double, so is b.
```



```
c = zeros(5,2); %c is a 5-by-2 array of 0 elements of type double.
d = c; %d is also a 5-by-2 array of 0 elements of type double.
e = [1 2 3 4 5; 6 7 8 9 0]; % e is a 5-by-2 array of type double.
```

The following rules apply to the use of variables that you declare implicitly in the body of an Embedded MATLAB function:

- Variables that you declare in the body of an Embedded MATLAB function disappear between calls, unless you declare them to be persistent between calls with the persistent statement.
- You cannot set the size of a variable by a first use assignment with indexing.

In MATLAB, you can declare the size of a variable using indexing. In Embedded MATLAB functions, this is not allowed. For example, the following initial assignment is not allowed in Embedded MATLAB functions:

```
g(3,2) = 14.6; %Not allowed for creating g.
           %OK for assigning value once created
```

In MATLAB, the preceding example declares `g` to be a 3-by-2 array of type double elements, in which the element `g(3,2)` is 14.6 and all other elements are 0. In Embedded MATLAB functions, this statement is not allowed.

- You can declare variables implicitly with first use typecast functions. In the following example code, you declare `y` and `z` to be integers with the following initial assignments:

```
x = 15; %Because constants are of type double, so is x.
y = int16(3); %y is a constant of type int16.
z = uint8(x); %z is x (double type) cast to uint8.
```

- Variables cannot be resized or cast to a different type once they are created in the function by a first use.

In the following example, the last two statements each flag an error:

```
x = 2.75 %OK
y = [1 2; 3 4] %OK
x = int16(x); %ERROR: cannot recast x
y = [1 2 3; 4 5 6] %ERROR: cannot resize y
```

Declaring Local Complex Variables Implicitly

Using complex variables in Embedded MATLAB functions differs, in part, from the way in which complex variables are used in MATLAB. In MATLAB, the

identity of a variable as complex is an attribute of the variable. In Embedded MATLAB functions, the identity of a variable as complex is part of its assigned type. Use the following rules to specify and use complex variables in Embedded MATLAB functions:

- You can declare a complex number in an Embedded MATLAB function through assignment to a complex constant, as shown in the following examples:

```
x = 5 + 6i; %x is a complex number by assignment.  
y = 7 + 8j; %y is a complex number by assignment.
```

Note You can use the symbol `i` or `j` in specifying an imaginary constant.

You can also declare a complex number with the function `complex`, as shown in the following example:

```
x = complex(5,6); %x is the complex number 5 + 6i.
```

- Cases in which a function can return a complex number for a real argument are handled individually for each function.

Generally, this can result in a complex result or a warning that the function takes only arguments producing real results. For example, for negative arguments, the function `sqrt` warns that only positive arguments are allowed.

- Complex numbers obey the general Embedded MATLAB rule that once a variable is typed and sized, it cannot be cast to another type or size.

In the following example, the variable `x` is declared complex and stays complex:

```
x = 1 + 2i; %x is declared a complex variable  
y = int16(x); %real and imaginary parts of y are int16  
x = 3; %x now has the value 3 + 0i
```

Conflicts can occur from operations with real operands that can have complex results. For example, the following code is flagged as an error:

```
z = 3; %sets type of z to double (real)
```

```
z = 3 + 2i; %ERROR - cannot recast z to complex.
```

The following is a possible workaround that you can use if you know that a variable can be assigned a complex number:

```
m = complex(3); %sets m to complex variable of value 3 + 0i  
m = 5 + 6.7i; %assigns a complex result to a complex number
```

- In general, if an expression has a complex number or variable in it, its result is a complex number, even if the result is 0.

For example, the following code produces the complex result z :

```
x = 2 + 3i;  
y = 2 - 3i;  
z = x + y; %z is 4 + 0i
```

In MATLAB, this code generates the real result $z = 0$. However, in Embedded MATLAB, when code for $z = x + y$ is generated, the types for x and y are known, but their values are not. Because either or both operands in this expression are complex, z is declared a complex variable requiring storage for both a real and an imaginary part. This means that z has the complex result $4 + 0i$ in Embedded MATLAB, not 4 as in MATLAB.

An exception to the preceding rule is a function call that takes complex arguments but produces real results, as shown in the following examples:

```
y = real(x); %y is the real part of the complex number x.  
y = imag(x); %y is the real-valued imaginary part of x.  
y = isreal(x); %y is false (0) for a complex number x.
```

Another exception is a function call that takes real arguments but produces complex results, as shown in the following example:

```
z = complex(x,y); %z is a complex number for a real x and y.
```

Functions in Embedded MATLAB Functions

Embedded MATLAB Function blocks support three types of functions that you can call in the body of the function: subfunctions, Embedded MATLAB run-time library functions, and MATLAB functions. See the descriptions for each of these Embedded MATLAB function call types in the following topics:

- “Calling Subfunctions in Embedded MATLAB Functions” on page 15-56
- “Calling Embedded MATLAB Run-Time Library Functions” on page 15-57
- “Calling MATLAB Functions” on page 15-57

Calling Subfunctions in Embedded MATLAB Functions

If you call a function in an Embedded MATLAB function, Simulink first tries to resolve it as a subfunction of the Embedded MATLAB function. Subfunctions are functions defined in the body of the Embedded MATLAB function. They work the same way in Embedded MATLAB functions that they do in MATLAB.

In the section “Programming the Embedded MATLAB Function” on page 15-9, you define an Embedded MATLAB Function block with the subfunction `avg` as shown.

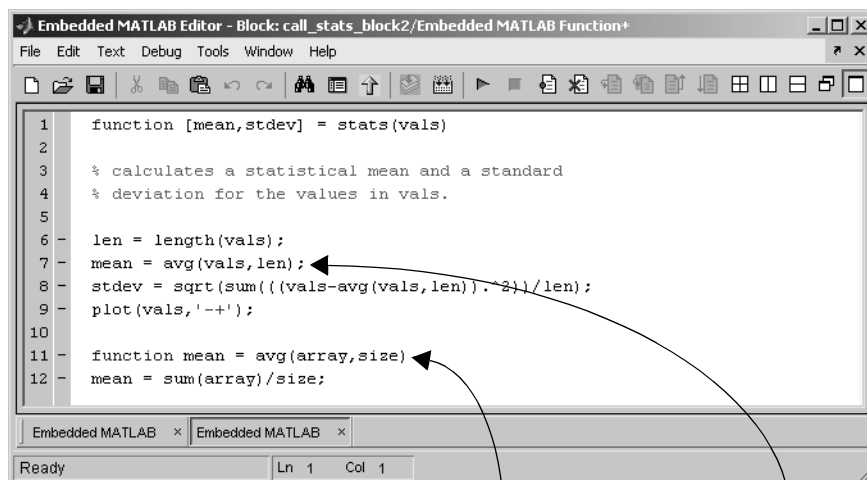

```
1 function [mean,stdev] = stats(vals)
2
3 % calculates a statistical mean and a standard
4 % deviation for the values in vals.
5
6 len = length(vals);
7 mean = avg(vals, len);
8 stdev = sqrt(sum(((vals-avg(vals, len)).^2)/len));
9 plot(vals, '-+');
10
11 function mean = avg(array,size)
12 mean = sum(array)/size;
```

Definition of subfunction avg

Call to subfunction avg

You can include subfunctions for Embedded MATLAB functions just as you would for ordinary MATLAB M-file functions. Subfunctions also can have multiple arguments and returns using any Embedded MATLAB function variable types and sizes. See “Subfunctions” in the MATLAB Programming documentation for a full description of subfunctions in MATLAB.

Calling Embedded MATLAB Run-Time Library Functions

If you call a function in an Embedded MATLAB Function block that cannot be resolved as a subfunction, the Embedded MATLAB Function block attempts to resolve it as a call to its own run-time library of functions. An Embedded MATLAB run-time library function is identical to a MATLAB function of the same name, but it is written in C to produce efficient embeddable generated code. It has the same name, same arguments (with limitations), and the same functionality (with limitations) as its MATLAB counterpart. If you restrict your function calls to Embedded MATLAB run-time library functions, you can use the code generated for an Embedded MATLAB function to build a stand-alone executable that you can move to different platforms for execution.

Currently, the Embedded MATLAB run-time library supports functions for a limited subset of MATLAB functions. Supported Embedded MATLAB run-time library functions are listed in “Embedded MATLAB Run-Time Function Library” in the Simulink Reference documentation. In addition to listing these functions, this section links to documentation for the original MATLAB function and lists any limitations of the Embedded MATLAB library version relative to the full MATLAB version.

Calling MATLAB Functions

During code generation for simulation targets, Embedded MATLAB functions attempt to resolve a called function as a subfunction or function in the Embedded MATLAB run-time library. If the called function is not found in these areas, the function call is resolved as a call to a MATLAB function in the MATLAB path. This applies to function calls of the following types only:

```
func(x);  
y = func(x);
```

If a function call in an Embedded MATLAB function is resolved as a call to a MATLAB function, you receive a diagnostic warning message when you generate code for the simulation target. For example, if you insert the line

```
x = magic(4);
```

in an Embedded MATLAB function, you receive the following diagnostic warning:

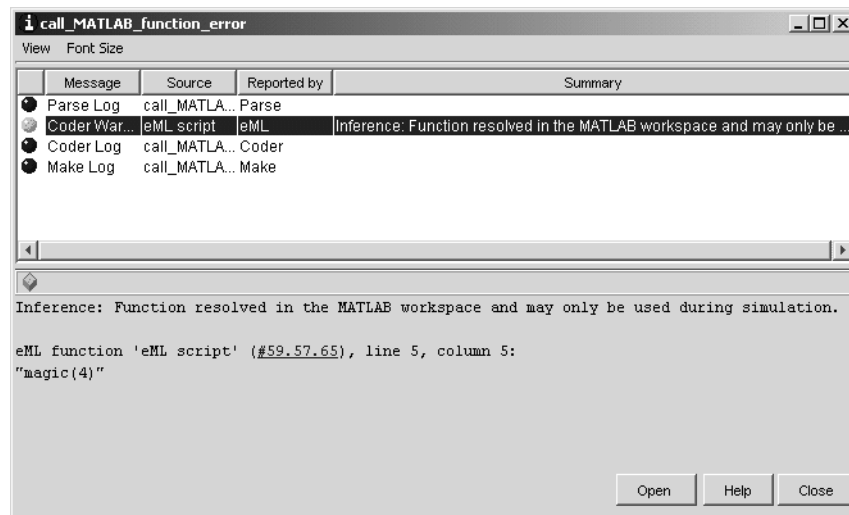

Notice that the warning includes a link to the offending line in the **Embedded MATLAB Editor**.

Note If you want to use a MATLAB function instead of its counterpart in the Embedded MATLAB run-time library, call the MATLAB function `feval`. This function lets you call MATLAB functions indirectly in MATLAB by providing a string name for the MATLAB function and a list of argument values. When you convert existing MATLAB functions and scripts to Embedded MATLAB functions, this feature lets you gradually migrate calls to MATLAB functions to calls to Embedded MATLAB run-time library functions.

Generated Code for MATLAB Function Calls

Generated code in a simulation target for a call to a MATLAB function in an Embedded MATLAB function includes only the call to the function. No code is included for the called function itself. This means that the simulation executable you build can execute only on a platform with MATLAB installed.

For Real-Time Workshop and custom targets, calls to MATLAB functions are not permitted. A fatal error message results when you try to build the target, and no code generation takes place at all.

Returning Values from MATLAB Functions

Function calls that are resolved in MATLAB have a return type of `mxArray`. You can store variables in this return type by assignment. For example, the line

```
x = magic(4);
```

stores a 4-by-4 array of type `mxArray` in `x`. You can pass this value to another function resolved in MATLAB as an argument. However, the `mxArray` type is not defined in Embedded MATLAB functions for operations with other types. For example, the lines

```
x = zeros(4); //x is a 4-by-4 array of type double
y = magic(4); //y is a 4-by-4 array of type mxArray
z = x + y; //Error: type mismatch!
```

receive the following run-time error:

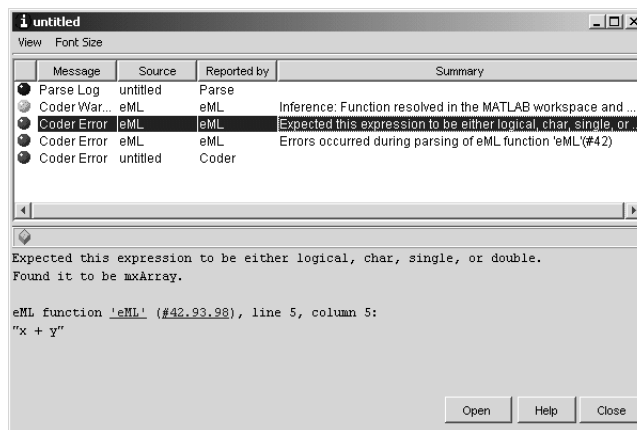

To prevent this error, you must set `y` to be a 4-by-4 matrix of type `double` before the assignment is made to the return value from the call `magic(4)`. You can do this by using the Embedded MATLAB run-time library function `zeros` as follows:

```
x = zeros(4); //x is a 4-by-4 array of type double
y = zeros(4); //y is a 4-by-4 array of type double
y = magic(4); //Return from magic converted to type double
z = x + y;
```

In this case, the Embedded MATLAB function knows that the call to the Embedded MATLAB run-time library function `zeros` with an argument of 4 returns a 4-by-4 matrix of type `double`, and `x` is sized accordingly. In the next line, `y = zeros(4)`, `y` becomes a 4-by-4 matrix of type `double` in the same way. In the next line, `y = magic(4)`, the return value from the call to the MATLAB function `magic` is converted at run-time to an array of type `double` for assignment to `y`. Finally, the last line, `z = x + y`, is now homogeneous in type.

In the preceding example, the line `y = zeros(4)` permanently sets both the type and size of `y`. This means that if you assign to `y` the results of `magic(5)` in the next line by mistake, a fatal size mismatch error results.

A

- Abs block
 - zero crossings 2-23
- absolute tolerance
 - definition 10-14
 - simulation accuracy 10-77
- accelbuild command
 - building Simulink Accelerator MEX-file 14-9
- AccelMakeCommand parameter
 - specifying custom Make command for Simulink Accelerator 14-10
- AccelSystemTargetFile parameter
 - specifying custom System target file for Simulink Accelerator 14-10
- AccelTemplateMakeFile parameter
 - specifying custom Template makefiles for Simulink Accelerator 14-10
- Action Port block
 - in subsystem 4-43
- Adams-Bashforth-Moulton PECE solver 10-13
- algebraic loops
 - direct feedthrough blocks 2-24
 - displaying 2-26
 - highlighting 13-35
 - identifying blocks in 13-32
 - simulation speed 10-77
- aligning blocks 5-5
- annotations
 - changing font 4-16
 - creating 4-16
 - definition 4-16
 - deleting 4-16
 - editing 4-16
 - moving 4-16
 - using symbols and Greek letters in 4-17
 - using TeX formatting commands in 4-17
 - using to document models 8-8

- Apply button on Mask Editor 12-13
- Assignment block
 - and For Iterator block 4-48
- Assignment mask parameter 12-18
- attributes format string 4-15
- AttributesFormatString block parameter 5-12
- Autoscale icon drawing coordinates 12-16

B

- Backlash block
 - zero crossings 2-23
- backpropagating sample time 2-38
- Backspace key
 - deleting annotations 4-16
 - deleting blocks 5-6
 - deleting labels 6-39
- Band-Limited White Noise block
 - simulation speed 10-77
- block callback parameters 4-92
- Block data tips 5-2
- block descriptions
 - creating 12-8
- block diagrams
 - printing 3-12
- block libraries
 - adding to Library Browser 5-38
 - creating 5-30
 - definition 5-29
 - modifying 5-30
 - new_system command 5-30
 - searching 5-38
- block names
 - changing location 5-17
 - copied blocks 5-4
 - editing 5-16

- flipping location 5-17
- generated for copied blocks 5-5
- hiding and showing 5-17
- location 5-15
- rules 5-15
- block parameters
 - about 5-7
 - displaying beneath a block 5-20
 - modifying during simulation 10-5
 - scalar expansion 6-14
 - setting 5-7
- block priorities
 - assigning 5-20
- Block Properties dialog box 5-9
- block type of masked block 12-25
- blocks
 - aligning 5-5
 - assigning priorities 5-20
 - associating user data with 7-30
 - callback routines 4-90
 - changing font 5-16
 - changing font names 5-16
 - changing location of names 5-17
 - checking connections 2-13
 - connecting automatically 4-9
 - connecting manually 4-11
 - copying from Library Browser 5-38
 - copying into models 5-4
 - copying to other applications 5-5
 - deleting 5-6
 - disconnecting 4-15
 - displaying sorted order on 5-20
 - drop shadows 5-15
 - duplicating 5-6
 - grouping to create subsystem 4-21
 - hiding block names 5-17
 - input ports with direct feedthrough 2-24
 - library 5-29
 - moving between windows 5-5
 - moving in a model 5-5
 - names
 - editing 5-16
 - orientation 5-14
 - reference 5-29
 - resizing 5-14
 - reversing signal flow through 8-3
 - showing block names 5-17
 - signal flow through 5-14
 - under mask 12-13
 - updating 2-13
- blocks
 - See also* block names 5-15
- Bogacki-Shampine formula 10-13
- Boolean type checking 10-48
- bounding box
 - grouping blocks for subsystem 4-21
 - selecting objects 4-3
- branch lines 4-12
- Break Library Link menu item 5-33
- breaking links to library block 5-33
- breakpoints
 - setting 13-22
 - setting at end of block 13-25
 - setting at timesteps 13-25
 - setting on nonfinite values 13-25
 - setting on step-size-limiting steps 13-26
 - setting on zero crossings 13-26
- Browser 9-22
- building models
 - exercise 1-9
 - tips 8-8
- Bus Editor 6-55
- bus objects, editing 6-55

C

- callback routines 4-90
- callback routines, referencing mask parameters in 4-92
- callback tracing 4-90
- Cancel button on Mask Editor 12-13
- changing
 - signal labels font 6-39
- Clear menu item 5-6
- Clock block
 - example 11-3
- Close Browser menu item 9-24
- Close Model menu item 9-24
- CloseFcn block callback parameter 4-92
- CloseFcn model callback parameter 4-91
- colors for sample times 2-38
- command line debugger for Embedded MATLAB
 - Function block 15-28
- CompiledSize property for Embedded MATLAB
 - Function block variables 15-47
- complex variables in Embedded MATLAB
 - Function block functions 15-53
- composite signals 6-6
- conditional execution behavior 4-38
- conditionally executed subsystems 4-26
- configurable subsystem 4-74
- Configuration Parameters dialog box 10-30
 - Data Import/Export pane 10-39
 - Diagnostics pane 10-48
 - increasing Simulink Accelerator performance 14-5
 - Solver pane 10-31
- Configuration Parameters menu item 1-16
- connecting blocks 4-11
- connecting lines to input ports 1-14
- ConnectionCallback
 - port callback parameters 4-95

- constant sample time 2-39
- continuous sample time 2-32
- control flow blocks
 - and Stateflow 4-50
- control flow diagrams
 - and Stateflow 4-42
 - compared to Stateflow 4-49
 - do-while 4-47
 - for 4-47
 - if-else 4-43
 - resetting of states 4-50
 - sample times 4-50
 - switch 4-44
 - while 4-46
- control flow subsystem 4-26
- control input 4-26
- control signal 4-26, 6-6
- Control System Toolbox
 - linearization 11-5
- copy
 - definition 5-29
- Copy menu item 5-4
- CopyFcn block callback parameter 4-92
- copying
 - blocks 5-4
 - signal labels 6-39
- Create Mask menu item 12-13
- Created model parameter 4-111
- Creator model parameter 4-111
- Cut menu item 5-5

D

- dash-dot lines 6-6
- Data Import/Export pane
 - Configuration Parameters dialog box 10-39
- data types

- displaying 7-5
- propagation 7-6
- specifying 7-5
- dbstop if error command 12-24
- dbstop if warning command 12-24
- Dead Zone block
 - zero crossings 2-23
- debugger
 - running incrementally 13-15
 - setting breakpoints 13-22
 - setting breakpoints at time steps 13-25
 - setting breakpoints at zero crossings 13-26
 - setting breakpoints on nonfinite values 13-25
 - setting breakpoints on step-size-limiting steps 13-26
 - skipping breakpoints 13-19
 - starting 13-11
 - stepping by time steps 13-18
- debugging
 - breakpoints in Embedded MATLAB Function block function 15-21
 - display variable values in Embedded MATLAB Function block function 15-27
 - displaying Embedded MATLAB Function block variables in MATLAB 15-28
 - Embedded MATLAB Function block example 15-20
 - Embedded MATLAB Function block function 15-20
 - operations for debugging Embedded MATLAB functions 15-37
 - stepping through Embedded MATLAB Function block function 15-22
- debugging initialization commands 12-22
- decimation factor
 - saving simulation output 10-23
- Delete key
 - deleting blocks 5-6
 - deleting signal labels 6-39
- DeleteFcn block callback parameter 4-93
- Derivative block
 - linearization 11-5
- Description model parameter 4-112
- description of masked blocks 12-26
- diagnosing simulation errors 10-72
- Diagnostics pane
 - Configuration Parameters dialog box 10-48
- diagonal line segments 4-13
- diagonal lines 4-12
- dialog boxes
 - creating for masked blocks 12-28
- direct feedthrough blocks 2-24
- direct-feedthrough ports 2-14
- disabled subsystem
 - output 4-27
- disabling zero-crossing detection 2-22
- disconnecting blocks 4-15
- discrete blocks
 - in enabled subsystem 4-29
 - in triggered systems 4-34
- discrete sample time 2-32
- Discrete-Time Integrator block
 - sample time colors 2-38
- discrete-time systems 2-31
- discretization methods 4-71
- discretizing a Simulink model 4-69
- Display Alphabetical List menu item 9-24
- Display Hierarchical List menu item 9-24
- dlinmod function
 - extracting linear models 11-4
- Documentation pane of Mask Editor 12-12
- Dormand-Prince
 - pair 10-13

do-while control flow diagram 4-47

drawing coordinates

Autoscale 12-16

normalized 12-16

Pixel 12-17

drop shadows 5-15

duplicating blocks 5-6

E

editing

Embedded MATLAB Function block function
code 15-30

editing look-up tables 5-22

either trigger event 4-31

Embedded MATLAB blocks

and Embedded MATLAB Language 15-1

description 15-1

Embedded MATLAB Editor

description 15-10

Embedded MATLAB Function blocks

and embedded applications 15-4

and MATLAB 15-4

and stand-alone executables 15-4

breakpoints in function 15-21

calling MATLAB functions 15-3, 15-13, 15-57

calling MATLAB functions with `feval` 15-58

calling other functions 15-56

comment and uncomment lines 15-34

creating model with 15-8

debugging 15-20

debugging example 15-20

debugging function for 15-20

debugging operations 15-37

description 15-2

diagnostic errors 15-15

display variable value 15-27

displaying variable values in MATLAB 15-28

Embedded MATLAB Editor 15-10, 15-30

Embedded MATLAB run-time library of
functions 15-3

example model with 15-7

example program 15-9

function library 15-12

implicitly declared variables 15-12

inherit data types and sizes 15-4

inheriting variable size 15-47

input values 15-52

library of real-time functions 15-57

model explorer 15-17

multiple inputs and outputs 15-4

names and ports 15-8

output values 15-52

parameter arguments 15-50

persistent variables 15-12, 15-53

Real-Time Workshop targets and calling
MATLAB functions 15-59

Real-Time Workshop targets, building 15-59

replace other Simulink blocks 15-5

return values from MATLAB functions 15-59

searching and replacing in function 15-34

simulating function 15-20

sizing variables 15-45

sizing variables by expression 15-48

stepping through function 15-22

subfunctions 15-3, 15-14, 15-56

tiling windows in editor 15-31

typing variables 15-39

typing with other variables 15-43

undo and redo operations 15-34

variable type by inheritance 15-41

variable types 15-42

variables 15-52

variables for 15-17

- variables in Model Explorer 15-52
 - variables, complex 15-53
 - variables, declaring implicitly 15-52
 - variables, declaring with Model Explorer 15-52
 - why use them? 15-4
 - Embedded MATLAB Language 15-1
 - Embedded MATLAB run-time library functions 15-3
 - Enable block
 - creating enabled subsystems 4-27
 - outputting enable signal 4-29
 - states when enabling 4-28
 - enabled subsystems 4-26
 - setting states 4-28
 - ending Simulink session 3-22
 - equations
 - modeling 8-2
 - error checking
 - Embedded MATLAB Function blocks 15-15
 - error tolerance 10-14, 10-35
 - simulation accuracy 10-77
 - simulation speed 10-76
 - eval command
 - masked block help 12-26
 - examples
 - Clock block 11-3
 - continuous system 8-3
 - converting Celsius to Fahrenheit 8-2
 - equilibrium point determination 11-7
 - linearization 11-4
 - masking 12-5
 - multirate discrete model 2-35
 - Outport block 11-2
 - return variables 11-2
 - To Workspace block 11-3
 - Transfer Function block 8-4
 - execution context
 - defined 4-38
 - displaying 4-39
 - propagating 4-38
 - Exit MATLAB menu item 3-22
 - Expand All menu item 9-24
 - Expand Library Links menu item 9-24
- F**
- falling trigger event 4-31
 - Fcn block
 - simulation speed 10-76
 - files
 - writing to 10-4
 - Final State check box 10-23
 - final states
 - saving 10-22
 - fixed in minor time step 2-32
 - fixed-point data 7-3
 - fixed-step solvers
 - definition 2-18
 - Flip Block menu item 5-14
 - Flip Name menu item 5-17
 - floating Display block 10-5
 - floating Scope block 10-5
 - font
 - annotations 4-16
 - block 5-16
 - block names 5-16
 - signal labels 6-39
 - Font menu item
 - changing block name font 5-16
 - changing the font of a signal label 6-39
 - for control flow diagram 4-47
 - For Iterator block
 - and Assignment block 4-48

- in subsystem 4-47
- output iteration number 4-48
- specifying number of iterations 4-48

functions

- Embedded MATLAB Function block run-time library 15-12

fundamental sample time 10-8

G

Gain block

- algebraic loops 2-24

get_param command

- checking simulation status 10-78

Go To Library Link menu item 5-34

Greek letters

- using in annotations 4-17

grouping blocks 4-20

H

handles on selected object 4-3

held output of enabled subsystem 4-28

held states of enabled subsystem 4-28

Help button on Mask Editor 12-13

help text for masked blocks 12-8

Hide Name menu item

- hiding block names 5-17
- hiding port labels 4-24

Hide Port Labels menu item 4-24

hiding block names 5-17

hierarchy of model

- advantage of subsystems 8-8
- replacing virtual subsystems 2-13

Hit Crossing block

- notification of zero crossings 2-21
- zero crossings

- and Disable zero crossing detection option 2-23

hybrid systems

- integrating 2-40

I

Icon pane of Mask Editor 12-12

icons

- creating for masked blocks 12-14

If block

- connecting outputs 4-43
- data input ports 4-43
- data output ports 4-43

if-else control flow diagram 4-43

- and Stateflow 4-50

inherited sample time 2-33

inheriting Embedded MATLAB Function block variable size 15-47

inheriting Embedded MATLAB Function variable types 15-41

InitFcn block callback parameter 4-93

InitFcn model callback parameter 4-91

initial conditions

- specifying 10-22

Initial State check box 10-23

initial states

- loading 10-23

initial step size

- simulation accuracy 10-77

initialization commands 12-23

- debugging 12-22

Initialization pane of Mask Editor 12-12

inlining S-functions using the TLC

- and Simulink Accelerator performance 14-11

Inport block

- in subsystem 4-21

- linearization 11-4
 - supplying input to model 10-16
 - inputs
 - loading from base workspace 10-16
 - mixing vector and scalar 6-14
 - scalar expansion 6-14
 - to Embedded MATLAB Function block 15-52
 - Integrator block
 - algebraic loops 2-24
 - example 8-3
 - sample time colors 2-38
 - simulation speed 10-77
 - zero crossings 2-23
 - invalid loops, avoiding 8-6
 - invalid loops, detecting 8-7
 - invariant constants 2-39
- J**
- Jacobian matrices 10-14
- K**
- keyboard actions summary 3-19
 - keyboard command 12-24
- L**
- labeling signals 6-38
 - labeling subsystem ports 4-24
 - LastModificationDate model parameter 4-112
 - libinfo command 5-36
 - libraries
 - See* block libraries
 - library blocks
 - breaking links to 5-33
 - definition 5-29
 - finding 5-34
 - getting information about 5-34
 - Library Browser 5-36
 - adding libraries to 5-38
 - copying blocks from 5-38
 - library links
 - creating 5-30
 - definition 5-29
 - disabling 5-31
 - displaying 5-35
 - modifying 5-31
 - propagating changes to 5-32
 - showing in Model Browser 9-23
 - status of 5-34
 - unresolved 5-31
 - line segments 4-12
 - diagonal 4-13
 - moving 4-13
 - line vertices
 - moving 4-14
 - linear models
 - extracting
 - example 11-4
 - linearization 11-4
 - lines
 - branch 4-12
 - carrying the same signal 1-14
 - connecting blocks 4-9
 - connecting to input ports 1-14
 - diagonal 4-12
 - moving 5-6
 - signals carried on 10-5
 - links
 - breaking 5-33
 - to library block 5-30
 - LinkStatus block parameter 5-34
 - linmod function

- example 11-4
- LoadFcn block callback parameter 4-93
- loading from base workspace 10-16
- loading initial states 10-23
- location of block names 5-15
- logging signals 6-27
- Look Into System menu item 9-24
- Look Under Mask Dialog menu item 9-24
- Look Under Mask menu item 12-13
- Look-Up Table Editor 5-22
- look-up tables, editing 5-22
- loops, algebraic
 - See algebraic loops
- loops, avoiding invalid 8-6
- loops, detecting invalid 8-7

M

- Mask Editor 12-12
- mask help text 12-8
- Mask Subsystem menu item 12-12
- mask type
 - defining 12-8
- mask workspace 12-24
- masked blocks
 - block descriptions 12-8
 - dialog boxes
 - creating dynamic 12-28
 - setting parameters for 12-28
 - documentation 12-25
 - help text 12-8
 - icons
 - creating 12-8
 - Icon pane 12-14
 - initialization commands 12-23
 - looking under 12-13
 - parameters
 - assigning values to 12-18
 - default values 12-22
 - mapping 12-5
 - predefined 12-29
 - prompts for 12-18
 - referencing in callbacks 4-92
 - showing in Model Browser 9-23
 - type 12-25
 - unmasking 12-13
- masked subsystems
 - showing in Model Browser 9-23
- Math Function block
 - algebraic loops 2-24
- mathematical symbols
 - using in annotations 4-17
- MATLAB
 - in Embedded MATLAB Function blocks 15-13
 - terminating 3-22
- MATLAB Fcn block
 - simulation speed 10-76
- MATLAB functions
 - calling in Embedded MATLAB Function block functions 15-3
 - returning values from in Embedded MATLAB Function blocks 15-59
- MATLAB functions in Embedded MATLAB Function blocks 15-57
- Max step size parameter 10-33
- maximum order of ode15s solver
 - and stability 10-35
- maximum step size 10-33
- mdl files 3-9
- Memory block
 - simulation speed 10-76
- memory issues 8-8
- menus 3-5
- M-file S-functions

- simulation speed 10-76
 - MinMax block
 - zero crossings 2-23
 - mixed continuous and discrete systems 2-40
 - Model Browser 9-22
 - showing library links in 9-23
 - showing masked subsystems in 9-23
 - model callback parameters 4-90
 - model discretization
 - configurable subsystems 4-74
 - discretizing a model 4-69
 - overview 4-68
 - specifying the discretization method 4-71
 - starting the model discretizer 4-70
 - Model Explorer
 - declaring variables for Embedded MATLAB Function block function 15-52
 - model explorer
 - Embedded MATLAB Function blocks 15-17
 - model file name, maximum size of 3-9
 - model files
 - mdl file 3-9
 - model navigation commands 4-23
 - model parameters for version control 4-111
 - model verification blocks
 - disabling 10-47
 - ModelCloseFcn block callback parameter 4-93
 - modeling equations 8-2
 - modeling strategies 8-8
 - models
 - building 1-9
 - callback routines 4-90
 - creating 4-2
 - creating change histories for 4-110
 - editing 3-4
 - navigating 4-23
 - organizing and documenting 8-8
 - printing 3-12
 - properties of 4-105
 - saving 3-9
 - selecting entire 4-4
 - tips for building 8-8
 - version control properties of 4-111
 - ModelVersion model parameter 4-112
 - ModelVersionFormat model parameter 4-112
 - ModifiedBy model parameter 4-111
 - ModifiedByFormat model parameter 4-112
 - ModifiedComment model parameter 4-112
 - ModifiedDate model parameter 4-112
 - ModifiedDateFormat model parameter 4-112
 - ModifiedHistory> model parameter 4-112
 - Monte Carlo analysis 10-78
 - mouse actions summary 3-19
 - MoveFcn block callback parameter 4-93
 - multirate systems
 - example 2-35
 - Mux block
 - changing number of input ports 1-13
- ## N
- NameChangeFcn block callback parameter 4-93
 - names
 - blocks 5-15
 - copied blocks 5-4
 - New Library menu item 5-29
 - New menu item 4-2
 - normalized icon drawing coordinates 12-16
 - numerical differentiation formula 10-13
 - numerical integration 2-15
- ## O
- objects

- selecting more than one 4-3
 - selecting one 4-3
 - ode113 solver
 - advantages 10-13
 - hybrid systems 2-40
 - Memory block
 - and simulation speed 10-76
 - ode15s solver
 - advantages 10-13
 - and stiff problems 10-76
 - hybrid systems 2-40
 - maximum order 10-35
 - Memory block
 - and simulation speed 10-76
 - unstable simulation results 10-77
 - ode23 solver 10-13
 - hybrid systems 2-40
 - ode23s solver
 - advantages 10-13
 - maximum order 10-35
 - simulation accuracy 10-77
 - ode45 solver
 - hybrid systems 2-40
 - Open menu item 3-4
 - Open System menu item 9-24
 - OpenFcn block callback parameter
 - identifying blocks that contain 9-25
 - Open System menu item 9-26
 - purpose 4-93
 - opening
 - Subsystem block 4-22
 - orientation of blocks 5-14
 - Output block
 - example 11-2
 - in subsystem 4-21
 - linearization 11-4
 - output
 - additional 10-24
 - between trigger events 4-33
 - disabled subsystem 4-27
 - enable signal 4-29
 - options 10-23
 - saving to workspace 10-20
 - smoother 10-24
 - specifying for simulation 10-24
 - trajectories
 - viewing 11-2
 - trigger signal 4-34
 - writing to file
 - when written 10-4
 - writing to workspace 10-20
 - when written 10-4
 - output ports
 - Enable block 4-29
 - Trigger block 4-34
 - outputs
 - from Embedded MATLAB Function block 15-52
- P**
- PaperOrientation model parameter 3-14
 - PaperPosition model parameter 3-15
 - PaperPositionMode model parameter 3-15
 - PaperType model parameter 3-14
 - parameter arguments for Embedded MATLAB Function blocks 15-50
 - parameters
 - block 5-7
 - setting values of 5-7
 - specifying configuration 1-16
 - tunable
 - definition 2-8
 - Inline parameters option 10-44

- Parameters pane of Mask Editor 12-12
- ParentCloseFcn block callback parameter 4-93
- Paste menu item 5-4
- performance
 - comparing Simulink Accelerator to Simulink 14-9
- Pixel icon drawing coordinates 12-17
- ports
 - block orientation 5-14
 - labeling in subsystem 4-24
- PostLoadFcn model callback parameter 4-91
- PostSaveFcn block callback parameter 4-94
- PostSaveFcn model callback parameter 4-91
- PostScript files
 - printing to 3-14
- preferences 1-18
- Preferences dialog box 1-19
- PreLoadFcn model callback parameter 4-91
- PreSaveFcn block callback parameter 4-94
- PreSaveFcn model callback parameter 4-91
- Print (Browser) menu item 9-24
- print command 3-12
- Print menu item 3-12
- printing to PostScript file 3-14
- Priority block parameter 5-20
- produce additional output option 10-24
- produce specified output only option 10-24
- Product block
 - algebraic loops 2-24
- purely discrete systems 2-35

Q

- Quit MATLAB menu item 3-22

R

- Random Number block
 - simulation speed 10-77
- Real-Time Workshop
 - and Simulink Accelerator 14-2
- Redo menu item 3-6
- reference blocks
 - definition 5-29
- refine factor
 - smoothing output 10-24
- Relational Operator block
 - zero crossings 2-23
- relative tolerance
 - definition 10-14
 - simulation accuracy 10-77
- Relay block
 - zero crossings 2-23
- reset
 - output of enabled subsystem 4-28
 - states of enabled subsystem 4-28
- resizing blocks 5-14
- return variables
 - example 11-2
- reversing direction of signal flow 8-3
- rising trigger event 4-31
- Rosenbrock formula 10-13
- Rotate Block menu item 5-14
- Runge-Kutta (2,3) pair 10-13
- Runge-Kutta (4,5) formula 10-13

S

- sample model 1-9
- sample time
 - backpropagating 2-38
 - changing during simulation 2-34
 - colors 2-38

- constant 2-39
- continuous 2-32
- discrete 2-32
- fixed in minor time step 2-32
- fundamental 10-8
- inherited 2-33
- simulation speed 10-76
- Sample Time Colors menu item 2-39
 - updating coloring 4-8
- sampled data systems 2-31
- Saturation block
 - zero crossings 2-23
 - how used 2-21
- Save As menu item 3-9
- Save menu item 3-9
- Save options area 10-20
- save_system command
 - breaking links 5-33
- scalar expansion 6-14
- Scope block
 - example of a continuous system 8-4
- Select All menu item 4-4
- Set Font dialog box 5-16
- set_param command
 - breaking link 5-33
 - controlling model execution 14-8
 - running a simulation 10-3, 10-78
 - setting simulation mode 14-8
- setting breakpoints 13-22
- Shampine, L. F. 10-14
- Show Browser menu item 9-24
- Show Name menu item 5-17
- show output port
 - Enable block 4-29
 - Trigger block 4-34
- Show Propagated Signals menu item 6-34
- showing block names 5-17
- Sign block
 - zero crossings 2-23
- Signal 6-50
- Signal Builder
 - snap grid 6-49
- Signal Builder dialog box 6-42
- Signal Builder time range
 - about 6-50
 - changing 6-50
- signal buses 6-10
- signal flow through blocks 5-14
- signal groups 6-41
 - activating 6-51
 - creating a custom waveform in 6-45
 - creating a set of 6-41
 - creating and deleting 6-44
 - creating signals in 6-44
 - cutting and pasting 6-45
 - discrete 6-54
 - editing 6-42
 - exporting to workspace 6-51
 - final values 6-52
 - hiding waveforms 6-44
 - moving 6-44
 - renaming 6-44
 - renaming signals in 6-51
 - running all 6-51
 - simulating with 6-51
 - specifying final values for 6-52
 - specifying sample time of 6-54
 - time range of 6-50
- signal labels
 - changing font 6-39
 - copying 6-39
 - creating 6-39
 - deleting 6-39
 - editing 6-39

- moving 6-39
 - using to document models 8-8
- signal logging, enabling 6-27
- signal propagation 6-4
- Signal Properties dialog box 6-30
- signals
 - composite 6-6
 - labeling 6-38
 - labels 6-39
 - names 6-38
 - reversing direction of flow 8-3
 - setting properties 6-30
 - showing propagated 6-34
 - storage class of 6-33
 - virtual 6-4
- signals, creating 6-2
- signals, logging 6-27
- sim command
 - comparing performance 14-9
 - simulating an accelerated model 14-9
 - syntax 10-78
- simulation
 - accuracy 10-77
 - checking status of 10-78
 - command line 10-78
 - displaying information about
 - algebraic loops 13-30
 - block execution order 13-32
 - block I/O 13-28
 - debug settings 13-35
 - integration 13-31
 - nonvirtual blocks 13-33
 - nonvirtual systems 13-33
 - system states 13-31
 - zero crossings 13-34
 - Embedded MATLAB Function block function 15-20
 - execution phase 2-15
 - parameters
 - specifying 10-72
 - running incrementally 13-15
 - running nonstop 13-19
 - speed 10-76
 - stepping by breakpoints 13-22
 - stepping by time steps 13-18
 - unstable results 10-77
- Simulation Diagnostics Viewer 10-72
- simulation errors
 - diagnosing 10-72
- Simulation Options dialog box 6-52
- simulation profile 14-15
- simulation time
 - compared to clock time 10-6, 10-32
 - writing to workspace 10-20
- Simulink
 - ending session 3-22
 - icon 3-2
 - menus 3-5
 - starting 3-2
 - terminating 3-22
 - windows and screen resolution 3-7
- Simulink Accelerator
 - blocks whose performance is not improved by 14-6
 - description 14-2
 - how to run 14-3
 - Simulink profiler 14-12
 - using with Simulink debugger 14-7
- Simulink block library
 - See* block libraries
- simulink command
 - starting Simulink 3-2
- Simulink Library Browser 3-2
- Simulink preferences 1-18

- Simulink profiler
 - purpose 14-12
- Simulink status bar 3-7
- size of block
 - changing 5-14
- sizing Embedded MATLAB Function block
 - variables by expression 15-48
- sizing Embedded MATLAB Function block
 - variables by inheritance 15-47
- sizing Embedded MATLAB Function variables 15-45
- slddebug command
 - starting the Simulink debugger 13-13
- snap grid, Signal Builder's 6-49
- Solver pane
 - Configuration Parameters dialog box 10-31
- solvers
 - fixed-step
 - definition 2-18
 - ode113
 - advantages 10-13
 - and simulation speed 10-76
 - ode15s
 - advantages 10-13
 - and simulation speed 10-76
 - and stiff problems 10-76
 - maximum order 10-35
 - simulation accuracy 10-77
 - ode23 10-13
 - ode23s
 - advantages 10-13
 - maximum order 10-35
 - simulation accuracy 10-77
- sorted order
 - displaying 5-20
- Source Control menu item 4-103
- speed of simulation 10-76
- stairs function 2-35
- Start menu item 8-3
- start time 10-6, 10-31
- StartFcn block callback parameter 4-94
- StartFcn model callback parameter 4-91
- starting Simulink 3-2
- starting the model discretizer 4-70
- Stateflow
 - and if-else control flow diagrams 4-50
 - and Simulink Accelerator performance 14-5
 - and switch control flow diagrams 4-50
 - and While subsystems 4-51
 - compared to control flow diagrams 4-49
- states
 - between trigger events 4-33
 - loading initial 10-23
 - saving final 10-22
 - when enabling 4-28
 - writing to workspace 10-20
- State-Space block
 - algebraic loops 2-24
- status
 - checking simulation 10-78
- status bar 3-7
- Step block
 - zero crossings 2-23
- step size
 - simulation speed 10-76
- stiff problems 10-14
- stiff systems
 - simulation speed 10-76
- stop time 10-6, 10-31
- StopFcn block callback parameter 4-94
- StopFcn model callback parameter 4-91
- storage class of signals
 - displaying 6-33
 - selecting 6-33

- subfunctions
 - in Embedded MATLAB Function block functions 15-3
 - in Embedded MATLAB Function blocks 15-14
- subfunctions in Embedded MATLAB Function blocks 15-56
- Subsystem block
 - adding to create subsystem 4-20
 - opening 4-22
 - zero crossings 2-24
- Subsystem Examples block library 8-6
- subsystem ports
 - labeling 4-24
- subsystems
 - controlling access to 4-24
 - creating 4-20
 - displaying parent of 4-23
 - labeling ports 4-24
 - model hierarchy 8-8
 - opening 4-23
 - triggered and enabled 4-35
 - underlying blocks 4-22
 - undoing creation of 4-22
- Sum block
 - algebraic loops 2-24
- summary of mouse and keyboard actions 3-19
- Switch block
 - zero crossings 2-24
- switch control flow diagram 4-44
 - and Stateflow 4-50
- SwitchCase block
 - adding cases 4-44
 - connecting to Action subsystem 4-45
 - data input 4-44
- T**
 - terminating MATLAB 3-22
 - terminating Simulink 3-22
 - terminating Simulink session 3-22
 - test point icons 6-36
 - test points 6-35
 - TeX commands
 - using in annotations 4-17
 - tic command
 - comparing performance 14-9
 - time interval
 - simulation speed 10-76
 - time range
 - of a Signal Builder block 6-50
 - tips for building models 8-8
 - To Workspace block
 - example 11-3
 - toc command
 - comparing performance 14-9
 - Transfer Fcn block
 - algebraic loops 2-24
 - example 8-4
 - Transport Delay block
 - linearization 11-5
 - Trigger block
 - creating triggered subsystem 4-32
 - outputting trigger signal 4-34
 - showing output port 4-34
 - triggered and enabled subsystems 4-35
 - triggered subsystems 4-31
 - triggers
 - control signal
 - outputting 4-34
 - either 4-31
 - events 4-31
 - falling 4-31
 - input 4-31

- rising 4-31
- type parameter 4-33
- tunable parameters
 - definition 2-8
 - Inline parameters option 10-44
- types of Embedded MATLAB Function variables 15-42
- typing Embedded MATLAB Function block
 - variables with other variables 15-43
- typing Embedded MATLAB Function variables 15-39

U

- Undo menu item 3-6
- UndoDeleteFcn block callback parameter 4-94
- Unmask button on Mask Editor 12-13
- unstable simulation results 10-77
- Update Diagram menu item
 - fixing bad link 5-31
 - out-of-date reference block 5-32
 - recoloring model 4-8
- updating a diagram programatically 10-78
- URL specification in block help 12-26
- user
 - specifying current 4-103
- user data 7-30
- UserData 7-30
- UserDataPersistent 7-30
- user-written S-functions
 - increasing Simulink Accelerator performance 14-5

V

- variables

- creating for Embedded MATLAB Function
 - blocks 15-17
- vector length
 - checking 2-13
- version control model parameters 4-111
- vertices
 - moving 4-14
- viewing output trajectories 11-2
- virtual blocks 5-2
- virtual signals 6-4

W

- web command
 - masked block help 12-26
- while control flow diagram 4-46
- While Iterator block
 - changing to do-while 4-47
 - condition input 4-46
 - in subsystem 4-46
 - initial condition input 4-46
 - iterator number output 4-47
- While subsystem
 - and Stateflow 4-51
- window reuse 4-23
- workspace
 - loading from 10-16
 - mask 12-24
 - saving to 10-20
 - writing to
 - simulation terminated or suspended 10-4

Z

- zero crossings
 - disabled by non-double data types 7-7
 - Saturation block 2-21

- zero-crossing detection
 - enabling globally 10-33
 - enabling selectively 10-33
- zero-crossing slope method 4-27
- Zero-Pole block
 - algebraic loops 2-24
- zooming block diagrams 3-7